



Programming Guide

VLT® Refrigeration Drive

Contents

1 Introduction	3
1.1.2 Symbols	3
1.1.3 Abbreviations	3
1.1.4 Definitions	4
1.1.5 Electrical wiring - Control Cables	8
2 How to Programme	11
2.1 Local Control Panel	11
2.1.1 How to Operate Graphical LCP (GLCP)	11
2.1.2 How to Operate Numeric LCP (NLCP)	15
2.1.9 Changing Data	22
2.1.10 Changing a Text Value	22
2.1.11 Changing a Group of Numeric Data Values	23
2.1.12 Value, Step-by-Step	23
3 Parameter Description	25
3.1 Parameter Selection	25
3.1.1 Main Menu Structure	25
3.2 Main Menu - Operation and Display - Group 0	25
3.3 Main Menu - Load and Motor - Group 1	36
3.4 Main Menu - Brakes - Group 2	48
3.5 Main Menu - Reference/Ramps - Group 3	50
3.6 Main Menu - Limits/Warnings - Group 4	55
3.7 Main Menu - Digital In/Out - Group 5	59
3.8 Main Menu - Analog In/Out - Group 6	72
3.9 Main Menu - Communications and Options - Group 8	78
3.10 Main Menu - Smart Logic - Group 13	84
3.11 Main Menu - Special Functions - Group 14	93
3.12 Main Menu - Frequency Converter Information - Group 15	99
3.13 Main Menu - Data Readouts - Group 16	104
3.14 Main Menu - Data Readouts 2 - Group 18	110
3.15 Main Menu - FC Closed Loop - Group 20	112
3.16 Main Menu - Extended Closed Loop - Group 21	121
3.17 Main Menu - Application Functions - Group 22	128
3.18 Main Menu - Time-based Functions - Group 23	140
3.19 Main Menu - Pack Controller - Group 25	150
3.20 Main Menu - Analog I/O Option MCB 109 - Group 26	157
3.21 Main Menu - Compressor Functions - Group 28	164
4 Parameter Lists	167

4.1 Parameter Options	167
4.1.1 Default settings	167
4.1.2 0-** Operation and Display	168
4.1.3 1-** Load/Motor	169
4.1.4 2-** Brakes	170
4.1.5 3-** Reference/Ramps	171
4.1.6 4-** Limits/Warnings	172
4.1.7 5-** Digital In/Out	172
4.1.8 6-** Analog In/Out	173
4.1.9 8-** Communication and Options	175
4.1.10 11-** FC 103 LON	176
4.1.11 13-** Smart Logic Controller	176
4.1.12 14-** Special Functions	177
4.1.13 15-** FC Information	177
4.1.14 16-** Data Readouts	179
4.1.15 18-** Info & Readouts	180
4.1.16 20-** FC Closed Loop	181
4.1.17 21-** Ext. Closed Loop	182
4.1.18 22-** Application Functions	183
4.1.19 23-** Time Based Functions	184
4.1.20 25-** Pack Controller	185
4.1.21 26-** Analog I/O Option MCB 109	186
4.1.22 28-** Compressor Functions	187
5 Troubleshooting	189
5.1.1 Alarms and Warnings	189
5.1.2 Alarm Words	192
5.1.3 Warning Words	193
5.1.4 Extended Status Words	194
5.1.5 Fault Messages	195
Index	199

1 Introduction

1.1.1 Software Version and Approvals: VLT® Refrigeration Drive FC 103

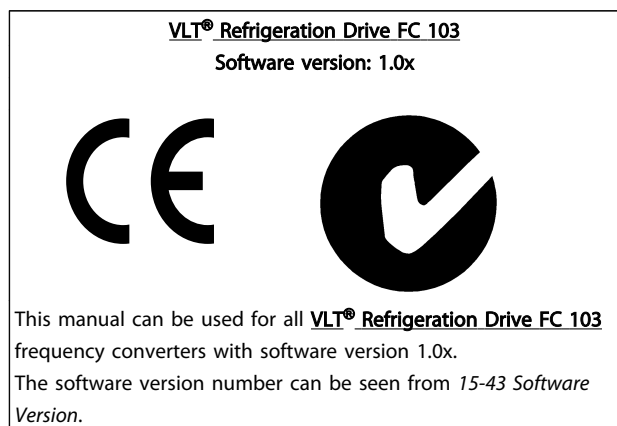

Table 1.1

1.1.2 Symbols

The following symbols are used in this manual.



Indicates a potentially hazardous situation which, if not avoided, could result in death or serious injury.



Indicates a potentially hazardous situation which, if not avoided, may result in minor or moderate injury. It may also be used to alert against unsafe practices.

CAUTION

Indicates a situation that may result in equipment or property-damage-only accidents.

NOTE

Indicates highlighted information that should be regarded with attention to avoid mistakes or operate equipment at less than optimal performance.

* Indicates default setting

Table 1.2

1.1.3 Abbreviations

Alternating current	AC
American wire gauge	AWG
Ampere/AMP	A
Automatic Motor Adaptation	AMA
Current limit	I_{LIM}
Degrees Celsius	°C
Direct current	DC
Drive Dependent	D-TYPE
Electro Magnetic Compatibility	EMC
Electronic Thermal Relay	ETR
Frequency converter	FC
Gram	g
Hertz	Hz
Horsepower	hp
Kilohertz	kHz
Local Control Panel	LCP
Meter	m
Millihenry Inductance	mH
Milliamper	mA
Millisecond	ms
Minute	min
Motion Control Tool	MCT
Nanofarad	nF
Newton Meters	Nm
Nominal motor current	$I_{M,N}$
Nominal motor frequency	$f_{M,N}$
Nominal motor power	$P_{M,N}$
Nominal motor voltage	$U_{M,N}$
Permanent Magnet motor	PM motor
Protective Extra Low Voltage	PELV
Printed Circuit Board	PCB
Rated Inverter Output Current	I_{INV}
Revolutions Per Minute	RPM
Regenerative terminals	Regen
Second	s
Synchronous Motor Speed	n_s
Torque limit	T_{LIM}
Volts	V
The maximum output current	$I_{VLT,MAX}$
The rated output current supplied by the frequency converter	$I_{VLT,N}$

Table 1.3

1.1.4 Definitions

Frequency converter

$I_{VLT,MAX}$

Maximum output current.

$I_{VLT,N}$

Rated output current supplied by the frequency converter.

$U_{VLT, MAX}$

Maximum output voltage.

Input

Control command

Start and stop the connected motor by means of LCP and digital inputs.

Functions are divided into two groups.

Functions in group 1 have higher priority than functions in group 2.

Group 1	Reset, Coasting stop, Reset and Coasting stop, Quick-stop, DC braking, Stop and the [OFF] key.
Group 2	Start, Pulse start, Reversing, Start reversing, Jog and Freeze output

Table 1.4

Motor:

Motor Running

Torque generated on output shaft and speed from zero rpm to max. speed on motor.

f_{JOG}

Motor frequency when the jog function is activated (via digital terminals).

f_M

Motor frequency.

f_{MAX}

Maximum motor frequency.

f_{MIN}

Minimum motor frequency.

$f_{M,N}$

Rated motor frequency (nameplate data).

I_M

Motor current (actual).

$I_{M,N}$

Rated motor current (nameplate data).

$n_{M,N}$

Rated motor speed (nameplate data).

n_s

Synchronous motor speed

$$n_s = \frac{2 \times par. 1 - 23 \times 60 s}{par. 1 - 39}$$

n_{slip}

Motor slip.

$P_{M,N}$

Rated motor power (nameplate data in kW or HP).

$T_{M,N}$

Rated torque (motor).

U_M

Instantaneous motor voltage.

$U_{M,N}$

Rated motor voltage (nameplate data).

Break-away torque

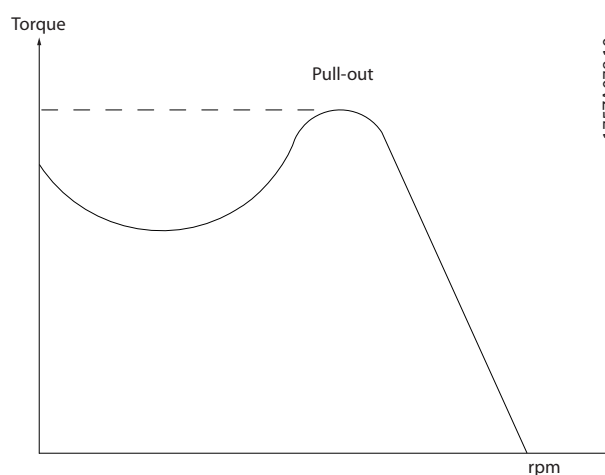

175ZA078.10

Illustration 1.1

η_{VLT}

The efficiency of the frequency converter is defined as the ratio between the power output and the power input.

Start-disable command

A stop command belonging to the group 1 control commands - see this group.

Stop command

See Control commands.

References

Analog Reference

A signal transmitted to the analog inputs 53 or 54, can be voltage or current.

Binary Reference

A signal transmitted to the serial communication port.

Preset Reference

A defined preset reference to be set from -100% to +100% of the reference range. Selection of eight preset references via the digital terminals.

Pulse Reference

A pulse frequency signal transmitted to the digital inputs (terminal 29 or 33).

Ref_{MAX}

Determines the relationship between the reference input at 100% full scale value (typically 10 V, 20 mA) and the resulting reference. The maximum reference value set in 3-03 *Maximum Reference*.

Ref_{MIN}

Determines the relationship between the reference input at 0% value (typically 0 V, 0 mA, 4 mA) and the resulting reference. The minimum reference value set in 3-02 *Minimum Reference*.

MiscellaneousAnalog Inputs

The analog inputs are used for controlling various functions of the frequency converter.

There are two types of analog inputs:

Current input, 0-20 mA and 4-20 mA

Voltage input, -10 to +10 V DC.

Analog Outputs

The analog outputs can supply a signal of 0-20 mA, 4-20 mA.

Automatic Motor Adaptation, AMA

AMA algorithm determines the electrical parameters for the connected motor at standstill.

Brake Resistor

The brake resistor is a module capable of absorbing the brake power generated in regenerative braking. This regenerative braking power increases the intermediate circuit voltage and a brake chopper ensures that the power is transmitted to the brake resistor.

CT Characteristics

Constant torque characteristics used for all applications such as conveyor belts, displacement pumps and cranes.

Digital Inputs

The digital inputs can be used for controlling various functions of the frequency converter.

Digital Outputs

The frequency converter features two Solid State outputs that can supply a 24 V DC (max. 40 mA) signal.

DSP

Digital Signal Processor.

ETR

Electronic Thermal Relay is a thermal load calculation based on present load and time. Its purpose is to estimate the motor temperature.

Hiperface®

Hiperface® is a registered trademark by Stegmann.

Initialising

If initialising is carried out (14-22 *Operation Mode*), the frequency converter returns to the default setting.

Intermittent Duty Cycle

An intermittent duty rating refers to a sequence of duty cycles. Each cycle consists of an on-load and an off-load period. The operation can be either periodic duty or non-periodic duty.

LCP

The Local Control Panel makes up a complete interface for control and programming of the frequency converter. The control panel is detachable and can be installed up to 3 m from the frequency converter, i.e. in a front panel with the installation kit option.

lsb

Least significant bit.

msb

Most significant bit.

MCM

Short for Mille Circular Mil, an American measuring unit for cable cross-section. 1 MCM = 0.5067mm².

On-line/Off-line Parameters

Changes to on-line parameters are activated immediately after the data value is changed. Changes to off-line parameters are not activated until you enter [OK] on the LCP.

Process PID

The PID control maintains the desired speed, pressure, temperature, etc. by adjusting the output frequency to match the varying load.

PCD

Process Control Data

Power Cycle

Switch off the mains until display (LCP) is dark – then turn power on again.

Pulse Input/Incremental Encoder

An external, digital pulse transmitter used for feeding back information on motor speed. The encoder is used in applications where great accuracy in speed control is required.

RCD

Residual Current Device.

Set-up

You can save parameter settings in four Set-ups. Change between the four parameter Set-ups and edit one Set-up, while another Set-up is active.

SFAVM

Switching pattern called Stator Flux oriented Asynchronous Vector Modulation (14-00 *Switching Pattern*).

Slip Compensation

The frequency converter compensates for the motor slip by giving the frequency a supplement that follows the measured motor load keeping the motor speed almost constant.

Smart Logic Control (SLC)

The SLC is a sequence of user defined actions executed when the associated user defined events are evaluated as true by the Smart Logic Controller. (Parameter group 13-** *Smart Logic Control (SLC)*).

STW

Status Word

FC Standard Bus

Includes RS-485 bus with FC protocol or MC protocol. See *8-30 Protocol*.

Thermistor

A temperature-dependent resistor placed where the temperature is to be monitored (frequency converter or motor).

Trip

A state entered in fault situations, e.g. if the frequency converter is subject to an over-temperature or when the frequency converter is protecting the motor, process or mechanism. Restart is prevented until the cause of the fault has disappeared and the trip state is cancelled by activating reset or, in some cases, by being programmed to reset automatically. Trip may not be used for personal safety.

Trip Locked

A state entered in fault situations when the frequency converter is protecting itself and requiring physical intervention, e.g. if the frequency converter is subject to a short circuit on the output. A locked trip can only be cancelled by cutting off mains, removing the cause of the fault, and reconnecting the frequency converter. Restart is prevented until the trip state is cancelled by activating reset or, in some cases, by being programmed to reset automatically. Trip may not be used for personal safety.

VT Characteristics

Variable torque characteristics used for pumps and fans.

VVC^{plus}

If compared with standard voltage/frequency ratio control, Voltage Vector Control (VVC^{plus}) improves the dynamics and the stability, both when the speed reference is changed and in relation to the load torque.

60 ° AVM

Switching pattern called 60 ° Asynchronous Vector Modulation (*14-00 Switching Pattern*).

Power Factor

The power factor is the relation between I_1 and I_{RMS} .

$$\text{Power factor} = \frac{\sqrt{3} \times U \times I_1 \cos\varphi}{\sqrt{3} \times U \times I_{RMS}}$$

The power factor for 3-phase control:

$$= \frac{I_1 \times \cos\varphi}{I_{RMS}} = \frac{I_1}{I_{RMS}} \text{ since } \cos\varphi = 1$$

The power factor indicates to which extent the frequency converter imposes a load on the mains supply.

The lower the power factor, the higher the I_{RMS} for the same kW performance.

$$I_{RMS} = \sqrt{I_1^2 + I_5^2 + I_7^2 + \dots + I_n^2}$$

In addition, a high power factor indicates that the different harmonic currents are low.

The frequency converters' built-in DC coils produce a high power factor, which minimizes the imposed load on the mains supply.

WARNING

The voltage of the frequency converter is dangerous whenever connected to mains. Incorrect installation of the motor, frequency converter or fieldbus may cause death, serious personal injury or damage to the equipment. Consequently, the instructions in this manual, as well as national and local rules and safety regulations, must be complied with.

Safety Regulations

1. The mains supply to the frequency converter must be disconnected whenever repair work is to be carried out. Check that the mains supply has been disconnected and that the necessary time has elapsed before removing motor and mains supply plugs.
2. [Off] does not disconnect the mains supply and consequently it must not be used as a safety switch.
3. The equipment must be properly earthed, the user must be protected against supply voltage and the motor must be protected against overload in accordance with applicable national and local regulations.
4. The earth leakage current exceeds 3.5 mA.
5. Protection against motor overload is not included in the factory setting. If this function is desired, set *1-90 Motor Thermal Protection* to data value ETR trip 1 [4] or data value ETR warning 1 [3].
6. Do not remove the plugs for the motor and mains supply while the frequency converter is connected to mains. Check that the mains supply has been disconnected and that the necessary time has elapsed before removing motor and mains plugs.

- Please note that the frequency converter has more voltage sources than L1, L2 and L3, when load sharing (linking of DC intermediate circuit) or external 24 V DC are installed. Check that all voltage sources have been disconnected and that the necessary time has elapsed before commencing repair work.

Warning against unintended start

- The motor can be brought to a stop by means of digital commands, bus commands, references or a local stop, while the frequency converter is connected to mains. If personal safety considerations (e.g. risk of personal injury caused by contact with moving machine parts following an unintentional start) make it necessary to ensure that no unintended start occurs, these stop functions are not sufficient. In such cases the mains supply must be disconnected or the Safe Stop function must be activated.
- The motor may start while setting the parameters. If this means that personal safety may be compromised (e.g. personal injury caused by contact with moving machine parts), motor starting must be prevented, for instance by use of the Safe Stop function or secure disconnection of the motor connection.
- A motor that has been stopped with the mains supply connected, may start if faults occur in the electronics of the frequency converter, through temporary overload or if a fault in the power supply grid or motor connection is remedied. If unintended start must be prevented for personal safety reasons (e.g. risk of injury caused by contact with moving machine parts), the normal stop functions of the frequency converter are not sufficient. In such cases the mains supply must be disconnected or the Safe Stop function must be activated.

NOTE

When using the Safe Stop function, always follow the instructions in the section *Safe Stop of the Design Guide*.

- Control signals from, or internally within, the frequency converter may in rare cases be activated in error, be delayed or fail to occur entirely. When used in situations where safety is critical, e.g. when controlling the electromagnetic brake function of a hoist application, these control signals must not be relied on exclusively.

WARNING

High Voltage

Touching the electrical parts may be fatal - even after the equipment has been disconnected from mains.

Also make sure that other voltage inputs have been disconnected, such as external 24 V DC, load sharing (linkage of DC intermediate circuit), as well as the motor connection for kinetic back up.

Systems where frequency converters are installed must, if necessary, be equipped with additional monitoring and protective devices according to the valid safety regulations, e.g. law on mechanical tools, regulations for the prevention of accidents etc. Modifications on the frequency converters by means of the operating software are allowed.

NOTE

Hazardous situations shall be identified by the machine builder/ integrator who is responsible for taking necessary preventive means into consideration. Additional monitoring and protective devices may be included, always according to valid national safety regulations, e.g. law on mechanical tools, regulations for the prevention of accidents.

NOTE

Crane, Lifts and Hoists:

The controlling of external brakes must always have a redundant system. The frequency converter can in no circumstances be the primary safety circuit. Comply with relevant standards, e.g.

Hoists and cranes: IEC 60204-32

Lifts: EN 81

Protection Mode

Once a hardware limit on motor current or dc-link voltage is exceeded the frequency converter will enter "Protection mode". "Protection mode" means a change of the PWM modulation strategy and a low switching frequency to minimize losses. This continues 10 s after the last fault and increases the reliability and the robustness of the frequency converter while re-establishing full control of the motor.

In hoist applications "Protection mode" is not usable because the frequency converter will usually not be able to leave this mode again and therefore it will extend the time before activating the brake - which is not recommendable. The "Protection mode" can be disabled by setting *14-26 Trip Delay at Inverter Fault* to zero which means that the frequency converter will trip immediately if one of the hardware limits is exceeded.

NOTE

It is recommended to disable protection mode in hoisting applications (*14-26 Trip Delay at Inverter Fault* = 0)

1.1.5 Electrical wiring - Control Cables

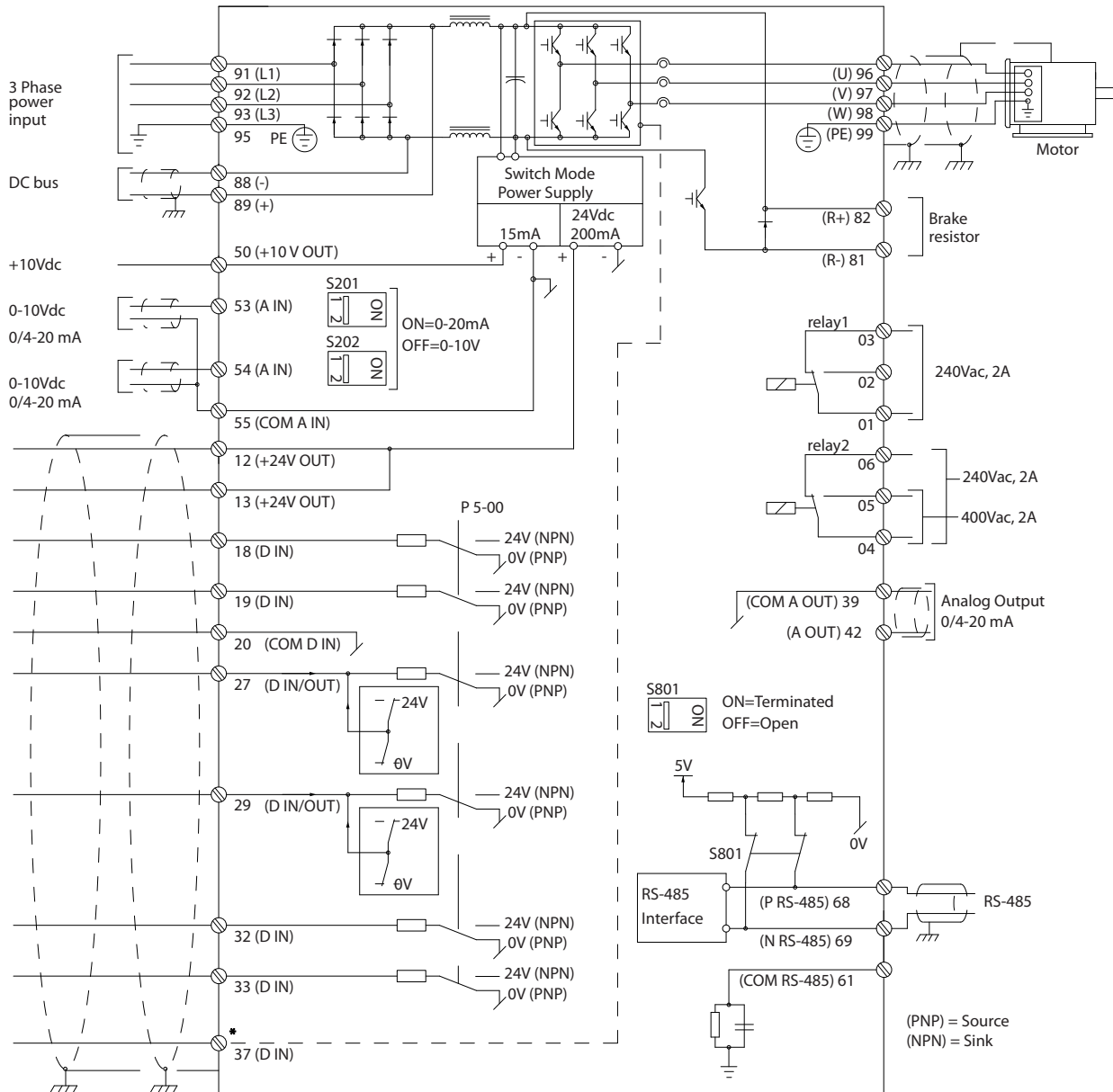

Illustration 1.2 Diagram showing all electrical terminals without options.

Terminal 37 is the input to be used for Safe Stop. For instructions on Safe Stop installation, refer to the section *Safe Stop Installation* in the Design Guide.

Very long control cables and analogue signals may in rare cases and depending on installation result in 50/60 Hz earth loops due to noise from mains supply cables.

example, switching on the digital input may disturb the analog input signal.

If this occurs, it may be necessary to break the screen or insert a 100 nF capacitor between screen and chassis.

The digital and analogue inputs and outputs must be connected separately to the common inputs (terminal 20, 55, 39) of the frequency converter to avoid ground currents from both groups to affect other groups. For

Input polarity of control terminals

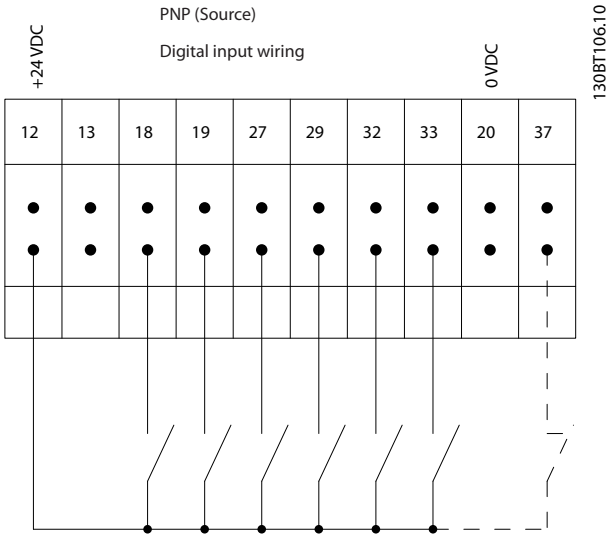

Illustration 1.3

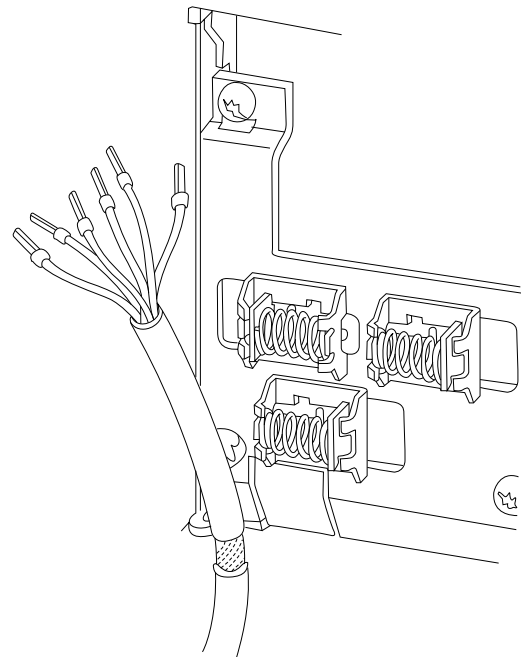

Illustration 1.5

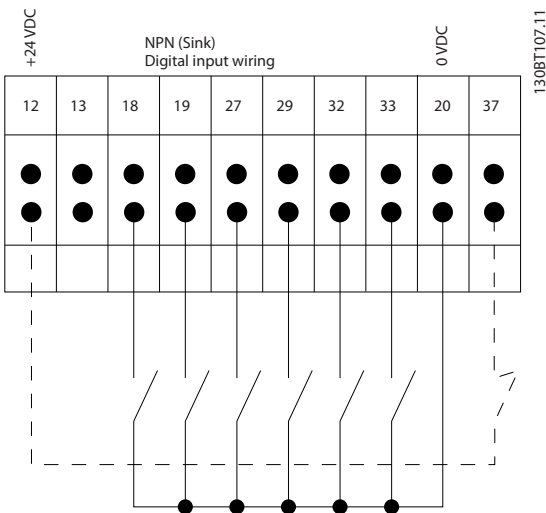
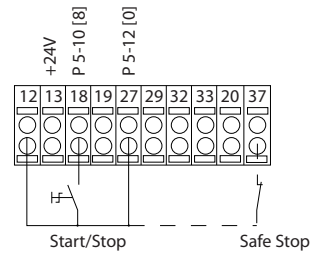

Illustration 1.4

1.1.6 Start/Stop

Terminal 18 = 5-10 Terminal 18 Digital Input [8] Start
 Terminal 27 = 5-12 Terminal 27 Digital Input [0] No operation (Default coast inverse)
 Terminal 37 = Safe stop (where available)



NOTE

Control cables must be screened/armoured.

See section entitled *Earthing of Screened/Armoured Control Cables* for the correct termination of control cables.

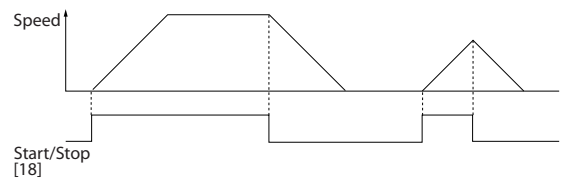
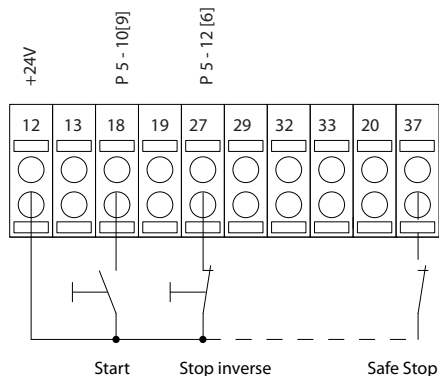

Illustration 1.6

1.1.7 Pulse Start/Stop

Terminal 18 = 5-10 Terminal 18 Digital Input Latched start, [9]
 Terminal 27 = 5-12 Terminal 27 Digital Input Stop inverse, [6]
 Terminal 37 = Safe stop (where available)



130BA156.12

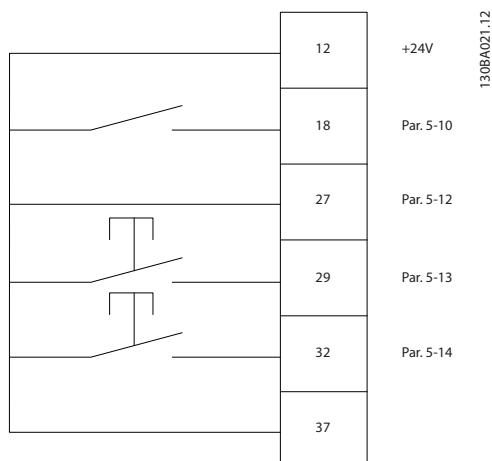

Illustration 1.8

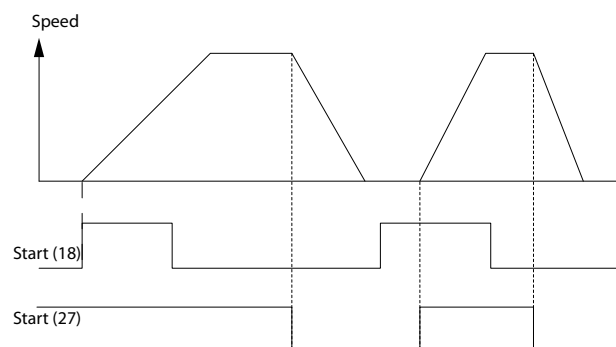

Illustration 1.7

1.1.8 Speed Up/Down

Terminals 29/32 = Speed up/down

- Terminal 18 = 5-10 Terminal 18 Digital Input Start [9] (default)
- Terminal 27 = 5-12 Terminal 27 Digital Input Freeze reference [19]
- Terminal 29 = 5-13 Terminal 29 Digital Input Speed up [21]
- Terminal 32 = 5-14 Terminal 32 Digital Input Speed down [22]

NOTE

Terminal 29 only in FC x02 (x=series type).

1.1.9 Potentiometer Reference

Voltage reference via a potentiometer

- Reference Source 1 = [1] Analog input 53 (default)
- Terminal 53, Low Voltage = 0 V
- Terminal 53, High Voltage = 10 V
- Terminal 53, Low Ref./Feedback = 0 RPM
- Terminal 53, High Ref./Feedback = 1500 RPM
- Switch S201 = OFF (U)

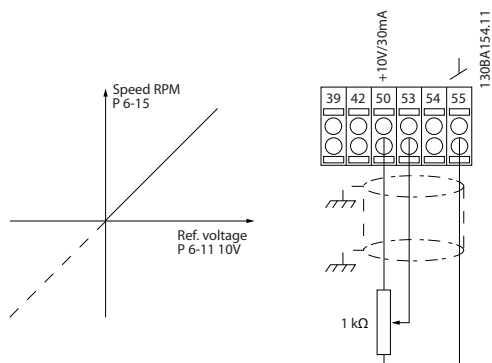

Illustration 1.9

2 How to Programme

2.1 Local Control Panel

2.1.1 How to Operate Graphical LCP (GLCP)

The following instructions are valid for the GLCP (LCP 102).

The GLCP is divided into four functional groups

1. Graphical display with Status lines.
2. Menu keys and indicator lights (LEDs) - selecting mode, changing parameters and switching between display functions.
3. Navigation keys and indicator lights (LEDs).
4. Operation keys and indicator lights (LEDs).

Graphical display

The LCD-display is back-lit with a total of 6 alpha-numeric lines. All data is displayed on the LCP which can show up to five operating variables while in [Status] mode.

Display lines

- a. **Status line** Status messages displaying icons and graphics.
- b. **Line 1-2** Operator data lines displaying data and variables defined or chosen by the user. By pressing the [Status] key, up to one extra line can be added.
- c. **Status line** Status messages displaying text.

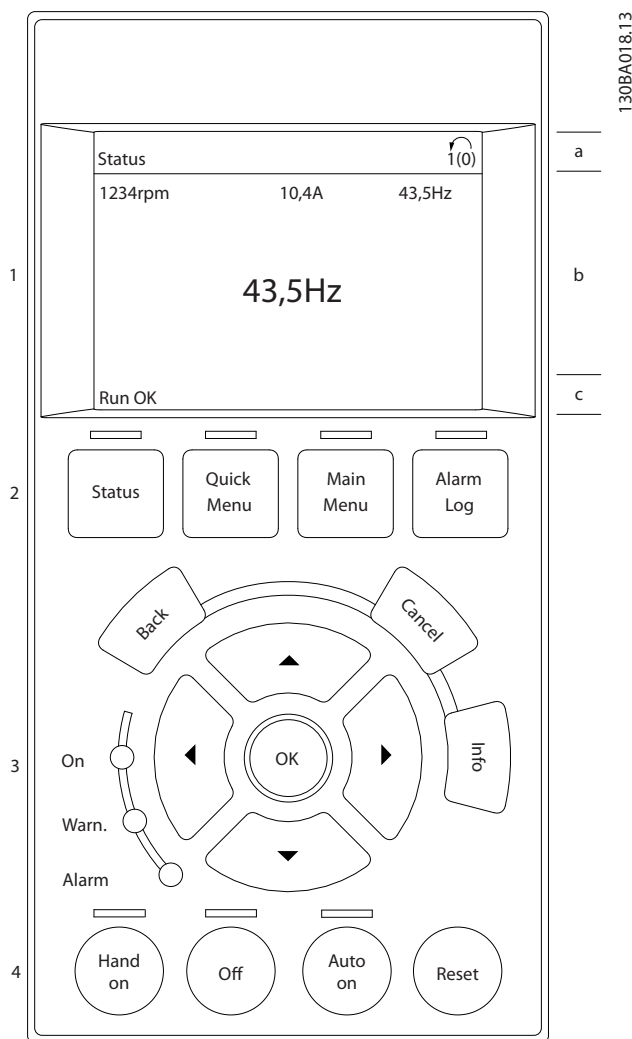

Illustration 2.1

The display is divided into 3 sections

Top section (a) shows the status when in status mode or up to 2 variables when not in status mode and in the case of Alarm/Warning.

The number of the Active Set-up (selected as the Active Set-up in 0-10 Active Set-up) is shown. When programming in another Set-up than the Active Set-up, the number of the Set-up being programmed appears to the right in brackets.

The **Middle section** (b) shows up to 5 variables with related unit, regardless of status. In case of alarm/warning, the warning is shown instead of the variables.

2

The **Bottom section** (c) always shows the state of the frequency converter in Status mode.

It is possible to toggle between three status read-out displays by pressing the [Status] key. Operating variables with different formatting are shown in each status screen - see below.

Several values or measurements can be linked to each of the displayed operating variables. The values / measurements to be displayed can be defined via *0-20 Display Line 1.1 Small, 0-21 Display Line 1.2 Small, 0-22 Display Line 1.3 Small, 0-23 Display Line 2 Large and 0-24 Display Line 3 Large*, which can be accessed via [QUICK MENU], "Q3 Function Setups", "Q3-1 General Settings", "Q3-13 Display Settings".

Each value/measurement readout parameter selected in *0-20 Display Line 1.1 Small to 0-24 Display Line 3 Large* has its own scale and number of digits after a possible decimal point. Larger numeric values are displayed with few digits after the decimal point.
 Ex.: Current readout
 5.25 A; 15.2 A 105 A.

Status display I

This read-out state is standard after start-up or initialisation.

Use [INFO] to obtain information about the value/ measurement linked to the displayed operating variables (1.1, 1.2, 1.3, 2, and 3).

See the operating variables shown in the display in this illustration. 1.1, 1.2 and 1.3 are shown in small size. 2 and 3 are shown in medium size.

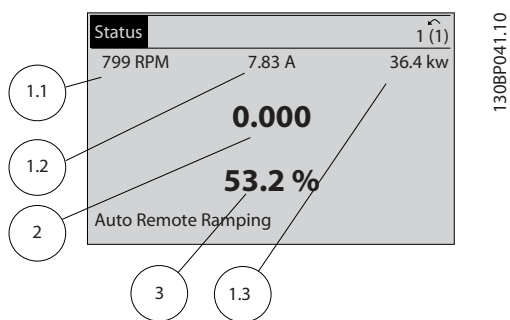

Illustration 2.2

Status display II

See the operating variables (1.1, 1.2, 1.3, and 2) shown in the display in this illustration.

In the example, Speed, Motor current, Motor power and Frequency are selected as variables in the first and second lines.

1.1, 1.2 and 1.3 are shown in small size. 2 is shown in large size.

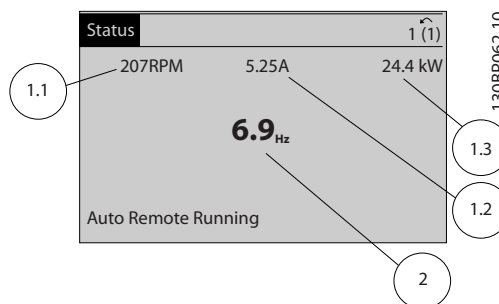

Illustration 2.3

Status display III

This state displays the event and action of the Smart Logic Control. For further information, see .

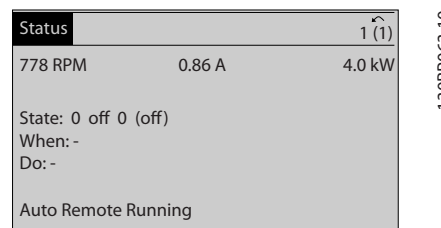

Illustration 2.4

Display Contrast Adjustment

Press [status] and [▲] for darker display
 Press [status] and [▼] for brighter display

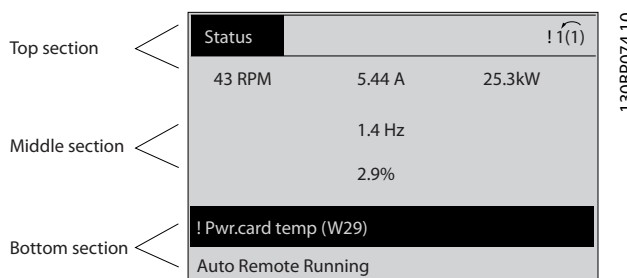

Illustration 2.5

Indicator lights (LEDs)

If certain threshold values are exceeded, the alarm and/or warning LED lights up. A status and alarm text appear on the control panel.

The On LED is activated when the frequency converter receives power from mains voltage, a DC bus terminal, or an external 24V supply. At the same time, the back light is on.

- Green LED/On: Control section is working.
- Yellow LED/Warn.: Indicates a warning.
- Flashing Red LED/Alarm: Indicates an alarm.

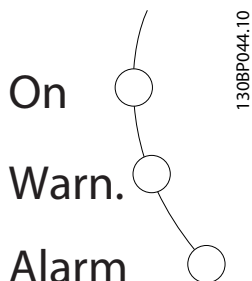

Illustration 2.6

GLCP keys

Menu keys

The menu keys are divided into functions. The keys below the display and indicator lamps are used for parameter set-up, including choice of display indication during normal operation.

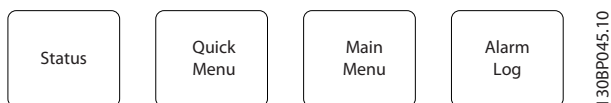

Illustration 2.7

[Status]

indicates the status of the frequency converter and/or the motor. 3 different readouts can be chosen by pressing the [Status] key: 5 line readouts, 4 line readouts or Smart Logic Control. Use [Status] for selecting the mode of display or for changing back to Display mode from either the Quick Menu mode, the Main Menu mode or Alarm mode. Also use the [Status] key to toggle single or double read-out mode.

[Quick Menu]

allows quick set-up of the frequency converter. **The most common ADAP-KOOL Drive FCR 103 functions can be programmed here.**

The [Quick Menu] consists of

- My Personal Menu
- Quick Set-up
- Function Set-up
- Changes Made
- Loggings

The Function set-up provides quick and easy access to all parameters required for the majority of ADAP-KOOL Drive FCR 103 applications including most VAV and CAV supply and return fans, cooling tower fans, Primary, Secondary and Condenser Water Pumps and other pump, fan and compressor applications. Amongst other features it also includes parameters for selecting which variables to display on the LCP, digital preset speeds, scaling of analog references, closed loop single zone and multi-zone applications and specific functions related to Fans, Pumps and Compressors.

The Quick Menu parameters can be accessed immediately unless a password has been created via 0-60 Main Menu Password, 0-61 Access to Main Menu w/o Password, 0-65 Personal Menu Password or 0-66 Access to Personal Menu w/o Password.

It is possible to switch directly between Quick Menu mode and Main Menu mode.

[Main Menu]

is used for programming all parameters. The Main Menu parameters can be accessed immediately unless a password has been created via 0-60 Main Menu Password, 0-61 Access to Main Menu w/o Password, 0-65 Personal Menu Password or 0-66 Access to Personal Menu w/o Password. For the majority of ADAP-KOOL Drive FCR 103 applications it is not necessary to access the Main Menu parameters but instead the Quick Menu, Quick Set-up and Function Set-up provides the simplest and quickest access to the typical required parameters.

It is possible to switch directly between Main Menu mode and Quick Menu mode.

Parameter shortcut can be carried out by pressing down the [Main Menu] key for 3 seconds. The parameter shortcut allows direct access to any parameter.

[Alarm Log]

displays an Alarm list of the ten latest alarms (numbered A1-A10). To obtain additional details about an alarm, use the arrow keys to manoeuvre to the alarm number and press [OK]. Information is displayed about the condition of the frequency converter before it enters the alarm mode.

The Alarm log button on the LCP allows access to both Alarm log and Maintenance log.

[Back]

reverts to the previous step or layer in the navigation structure.



Illustration 2.8

[Cancel]

last change or command will be cancelled as long as the display has not been changed.



Illustration 2.9

[Info]

displays information about a command, parameter, or function in any display window. [Info] provides detailed information when needed.

Exit Info mode by pressing either [Info], [Back], or [Cancel].



Illustration 2.10

Navigation Keys

The four navigation arrows are used to navigate between the different choices available in **[Quick Menu]**, **[Main Menu]** and **[Alarm Log]**. Use the keys to move the cursor.

[OK] is used for choosing a parameter marked by the cursor and for enabling the change of a parameter.

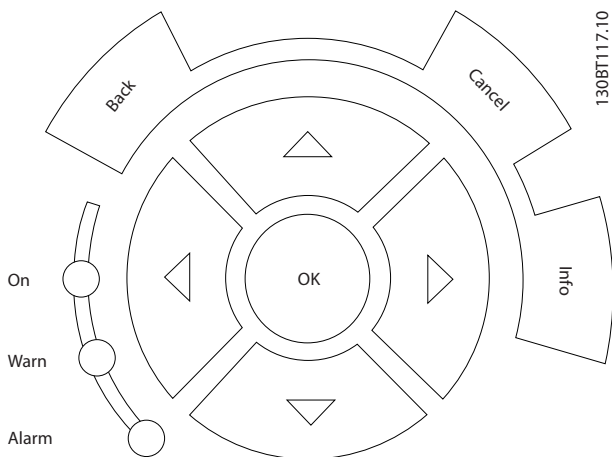

Illustration 2.11

Operation Keys for local control are found at the bottom of the control panel.

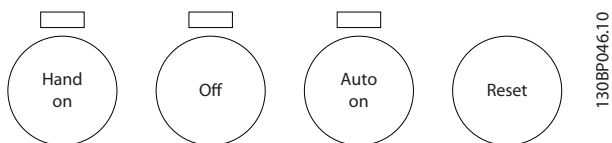

Illustration 2.12

[Hand On]

enables control of the frequency converter via the GLCP. [Hand On] also starts the motor, and it is now possible to enter the motor speed data by means of the arrow keys. The key can be selected as *Enable* [1] or *Disable* [0] via 0-40 [Hand on] Key on LCP.

The following control signals will still be active when [Hand On] is activated:

- [Hand On] - [Off] - [Auto On]
- Reset
- Coasting stop inverse
- Reversing
- Set-up select lsb - Set-up select msb
- Stop command from serial communication
- Quick stop
- DC brake

NOTE

External stop signals activated by means of control signals or a serial bus will override a “start” command via the LCP.

[Off]

stops the connected motor. The key can be selected as Enabled [1] or Disabled [0] via 0-41 [Off] Key on LCP. If no external stop function is selected and the [Off] key is inactive the motor can only be stopped by disconnecting the mains supply.

[Auto On]

enables the frequency converter to be controlled via the control terminals and/or serial communication. When a start signal is applied on the control terminals and/or the bus, the frequency converter will start. The key can be selected as Enabled [1] or Disabled [0] via 0-42 [Auto on] Key on LCP.

NOTE

An active HAND-OFF-AUTO signal via the digital inputs has higher priority than the control keys [Hand On] – [Auto On].

[Reset]

is used for resetting the frequency converter after an alarm (trip). It can be selected as [1] *Enable* or [0] *Disable* via 0-43 [Reset] Key on LCP.

The parameter shortcut can be carried out by holding down the [Main Menu] key for 3 seconds. The parameter shortcut allows direct access to any parameter.

2.1.2 How to Operate Numeric LCP (NLCP)

The following instructions are valid for the NLCP (LCP 101). The control panel is divided into four functional groups:

1. Numeric display.
2. Menu key and indicator lights (LEDs) - changing parameters and switching between display functions.
3. Navigation keys and indicator lights (LEDs).
4. Operation keys and indicator lights (LEDs).

NOTE

Parameter copy is not possible with Numeric Local Control Panel (LCP101).

Select one of the following modes:

Status Mode: Displays the status of the frequency converter or the motor.

If an alarm occurs, the NLCP automatically switches to status mode. A number of alarms can be displayed.

Quick Set-up or Main Menu Mode: Display parameters and parameter settings.

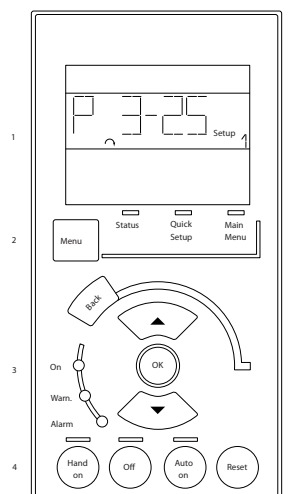

Illustration 2.13 Numerical LCP (NLCP)

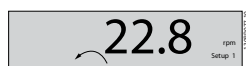

Illustration 2.14 Status Display Example

Indicator lights (LEDs):

- Green LED/On: Indicates if control section is on.
- Yellow LED/Wrn.: Indicates a warning.
- Flashing red LED/Alarm: Indicates an alarm.



Illustration 2.15 Alarm Display Example

Menu key

[Menu] Select one of the following modes:

- Status
- Quick Setup
- Main Menu

Main Menu is used for programming all parameters.

The parameters can be accessed immediately unless a password has been created via *0-60 Main Menu Password*, *0-61 Access to Main Menu w/o Password*, *0-65 Personal Menu Password* or *0-66 Access to Personal Menu w/o Password*.

Quick Setup is used to set up the frequency converter using only the most essential parameters.

The parameter values can be changed using the up/down arrows when the value is flashing.

Select Main Menu by pressing the [Menu] key a number of times until the Main Menu LED is lit.

Select the parameter group [xx-__] and press [OK]

Select the parameter [__-xx] and press [OK]

If the parameter is an array parameter select the array number and press [OK]

Select the wanted data value and press [OK]

Navigation Keys [Back] for stepping backwards

Arrow [▼] [▲] keys are used for manoeuvring between parameter groups, parameters and within parameters.

[OK] is used for choosing a parameter marked by the cursor and for enabling the change of a parameter.

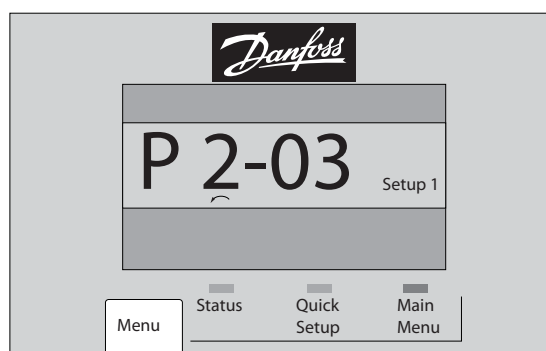

Illustration 2.16

Operation Keys

Keys for local control are found at the bottom of the control panel.

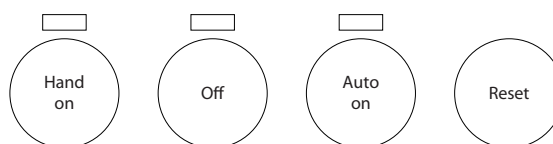

Illustration 2.17 Operation keys of the numerical CP (NLCP)

[Hand On] enables control of the frequency converter via the LCP. [Hand On] also starts the motor and it is now possible to enter the motor speed data by means of the arrow keys. The key can be selected as [1] Enable or [0] Disable via *0-40 [Hand on] Key on LCP*.

External stop signals activated by means of control signals or a serial bus will override a 'start' command via the LCP. The following control signals will still be active when [Hand on] is activated:

- [Hand On] - [Off] - [Auto On]
- Reset
- Coasting stop inverse
- Reversing
- Set-up select lsb - Set-up select msb
- Stop command from serial communication
- Quick stop
- DC brake

[Off] stops the connected motor. The key can be selected as [1] Enable or [0] Disable via *0-41 [Off] Key on LCP*. If no external stop function is selected and the [Off] key is inactive the motor can be stopped by disconnecting the mains supply.

[Auto On] enables the frequency converter to be controlled via the control terminals and/or serial communi-

cation. When a start signal is applied on the control terminals and/or the bus, the frequency converter will start. The key can be selected as [1] Enable or [0] Disable via 0-42 [Auto on] Key on LCP.

NOTE

An active HAND-OFF-AUTO signal via the digital inputs has higher priority than the control keys [Hand On] [Auto On].

[Reset] is used for resetting the frequency converter after an alarm (trip). It can be selected as [1] Enable or [0] Disable via 0-43 [Reset] Key on LCP.

2.1.3 Quick Transfer of Parameter Settings between Multiple Frequency Converters

Once the set-up of a frequency converter is complete, we recommend that you store the data in the LCP or on a PC via MCT 10 Set-up Software Tool.

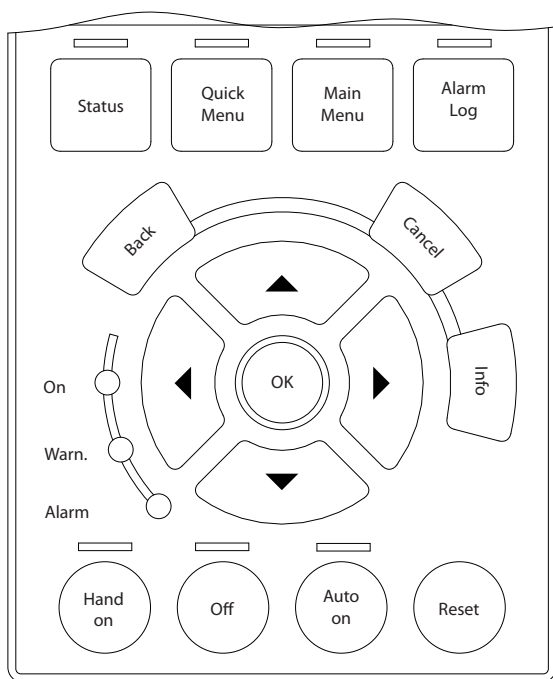

Illustration 2.18

Data storage in LCP

1. Go to 0-50 LCP Copy
2. Press the [OK] key
3. Select "All to LCP"
4. Press the [OK] key

All parameter settings are now stored in the LCP indicated by the progress bar. When 100% is reached, press [OK].

NOTE

Stop the motor before performing this operation.

Connect the LCP to another frequency converter and copy the parameter settings to this frequency converter as well.

Data transfer from LCP to frequency converter

1. Go to 0-50 LCP Copy
2. Press the [OK] key
3. Select "All from LCP"
4. Press the [OK] key

The parameter settings stored in the LCP are now transferred to the frequency converter indicated by the progress bar. When 100% is reached, press [OK].

NOTE

Stop the motor before performing this operation.

2.1.4 Parameter Set-Up

The frequency converter can be used for practically all assignments, thus offering a significant number of parameters. The series offers a choice between two programming modes - the Quick Menu mode and the Main Menu mode.

The latter provides access to all parameters. The former takes the user through a few parameters making it possible to program the majority of ADAP-KOOL Drive FCR 103 applications.

Regardless of the mode of programming, parameters can be changed in both Quick Menu mode and in Main Menu mode.

2.1.5 Quick Menu Mode

Parameter Data

The graphical display (GLCP) provides access to all parameters listed under the Quick Menus. To set parameters using the [Quick Menu] key - enter or change parameter data or settings in accordance with the following procedure:

1. Press Quick Menu button
2. Press [▲] and [▼] to find the parameter you want to change
3. Press [OK]
4. Press [▲] and [▼] to select the correct parameter setting
5. Press [OK]
6. To move to a different digit within a parameter setting, press [◀] and [▶]

7. Highlighted area indicates digit selected for change
8. Press [Cancel] button to disregard change, or press [OK] to accept change and enter the new setting

Example of Changing Parameter Data

Assume 22-60 *Broken Belt Function* is set to [0 Off]. However, you want to monitor the fan-belt condition - non- broken or broken - according to the following procedure:

1. Press Quick Menu key
2. Choose Function Setups with the [▼] key
3. Press [OK]
4. Choose Application Settings with the [▼] key
5. Press [OK]
6. Press [OK] again for Fan Functions
7. Choose Broken Belt Function by pressing [OK]
8. With [▼], choose [2] Trip

The frequency converter will now trip if a broken fan-belt is detected.

Select [My Personal Menu] to display only the parameters, which have been pre-selected and programmed as personal parameters. For example, an AHU or pump OEM may have pre-programmed these to be in My Personal Menu during factory commissioning to make on-site commissioning / fine tuning simpler. These parameters are selected in 0-25 *My Personal Menu*. Up to 20 different parameters can be programmed in this menu.

If [0 *No Operation*] is selected in 5-12 *Terminal 27 Digital Input*, no connection to +24 V on terminal 27 is necessary to enable start.

If [2 *Coast Inverse*] (factory default value) is selected in 5-12 *Terminal 27 Digital Input*, a connection to +24 V is necessary to enable start.

Select [Changes Made] to get information about:

- the last 10 changes. Use the up/down navigation keys to scroll between the last 10 changed parameters.
- the changes made since factory setting.

Select [Loggings] to get information about the display line read-outs. The information is shown as graphs.

Only display parameters selected in 0-20 *Display Line 1.1 Small* and 0-24 *Display Line 3 Large* can be viewed. It is possible to store up to 120 samples in the memory for later reference.

Efficient Parameter Set-up for VLT Refrigeration Drive Applications

The parameters can easily be set up for the vast majority of the VLT Refrigeration Drive applications only by using the [Quick Setup] option.

After pressing [Quick Menu], the different choices in the Quick Menu are listed. See also illustration 6.1 below and tables Q3-1 to Q3-4 in 2.1.6 *Function Setups*.

Example of using the Quick Setup option

Assume you want to set the Ramp Down Time to 100 seconds

1. Select [Quick Setup]. The first parameter 0-01 *Language* in Quick Setup appears
2. Press [▼] repeatedly until 3-42 *Ramp 1 Ramp Down Time* appears with the default setting of 20 seconds
3. Press [OK]
4. Press [◀] to highlight the 3rd digit before the comma
5. Change '0' to '1' by pressing [▲]
6. Press [▶] to highlight the digit '2'
7. Change '2' to '0' with the [▼] button
8. Press [OK]

The new ramp-down time is now set to 100 seconds. It is recommended to do the set-up in the order listed.

NOTE

A complete description of the function is found in the parameter sections of these Operating Instructions.

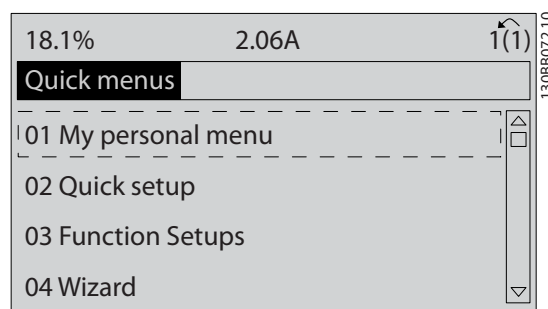

Illustration 2.19 Quick Menu view.

The Quick Setup menu gives access to the 13 most important setup parameters of the drive. After programming the drive will, in most cases be ready for operation. The 13* Quick Setup parameters are shown in the table below. A complete description of the function is given in the parameter description sections of this manual. The display showing depends on choices made in 0-02 *Motor Speed Unit* and 0-03 *Regional Settings*. The default settings of 0-02 *Motor Speed Unit* and 0-03 *Regional*

Settings depend on which region of the world the frequency converter is supplied to but can be re-programmed as required.

Par.	Designation	[Units]
0-01	Language	
1-03	Torque characteristics	
1-20	Motor Power	[kW]
1-21	Motor Power*	[HP]
1-22	Motor Voltage	[V]
1-23	Motor Frequency	[Hz]
1-24	Motor Current	[A]
1-25	Motor Nominal Speed	[RPM]
1-39	Motor Poles	
4-12	Motor Speed Low Limit*	[Hz]
4-14	Motor Speed High Limit*	[Hz]
3-02	Minimum Reference	
3-03	Maximum Reference	
3-41	Ramp 1 Ramp up Time	[s]
3-42	Ramp 1 Ramp down Time	[s]
3-13	Reference Site	
5-10	Terminal 18 Digital Input	
1-29	Automatic Motor Adaptation (AMA)	

Table 2.1 Quick Setup parameters

2.1.6 Function Setups

2

The Function set-up provides quick and easy access to all parameters required for the majority of VLT Refrigeration Drive applications including most VAV and CAV supply and return fans, cooling tower fans, Primary, Secondary and Condenser Water Pumps and other pump, fan and compressor applications.

How to access Function Set-up - example
How to change the output on "Analog output 42"

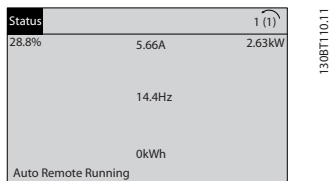

Illustration 2.20 Step 1: Turn on the frequency converter (yellow LED lights)

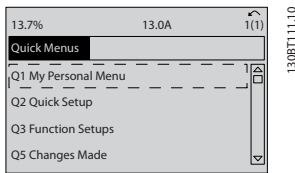

Illustration 2.21 Step 2: Press the [Quick Menus] key (Quick Menu choices appear).

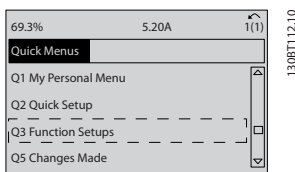

Illustration 2.22 Step 3: Press ▲/▼ to scroll down to Function Setups. Press [OK].

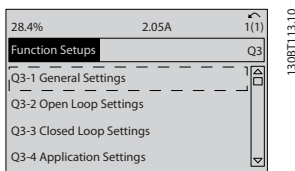

Illustration 2.23 Step 4: Function Setups choices appear. Choose Q3-1 General Settings. Press [OK].

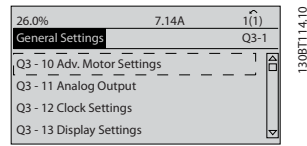

Illustration 2.24 Step 5: Press ▲/▼ to scroll down to i.e. Q3-11 Analog Outputs. Press [OK].

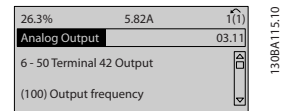

Illustration 2.25 Step 6: Choose 6-50 Terminal 42 Output. Press [OK].

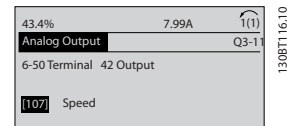

Illustration 2.26 Step 7: Press ▲/▼ to select between the different choices. Press [OK].

NOTE

For the quickest and easiest setup of the FC 103, please use the FC 103 Wizard (see chapter *Introduction*)

The Function Setup parameters are grouped in the following way:

Q3-1 General Settings			
Q3-10 Adv. Motor Settings	Q3-11 Analog Output	Q3-12 Clock Settings	Q3-13 Display Settings
1-90 Motor Thermal Protection	6-50 Terminal 42 Output	0-70 Set date and time	0-20 Display Line 1.1 Small
1-93 Thermistor Source	6-51 Terminal 42 Output min. scale	0-71 Date format	0-21 Display Line 1.2 Small
1-29 Automatic Motor Adaption	6-52 Terminal 42 Output max. scale	0-72 Time format	0-22 Display Line 1.3 Small
14-01 Switching Frequency		0-74 DST/Summertime	0-23 Display Line 2 large
		0-76 DST/Summertime start	0-24 Display Line 3 large
		0-77 DST/Summertime end	0-37 Display Text 1
			0-38 Display Text 2
			0-39 Display Text 3

Table 2.2

Q3-2 Open Loop Settings
1-00 Configuration Mode
3-02 Minimum Reference
3-03 Maximum reference
3-15 Reference 1 Source
6-10 Terminal 53 Low Voltage
6-11 Terminal 53 High Voltage
6-14 Terminal 53 Low Reference / Feedb. value
6-15 Terminal 53 High ref / Feed. value
3-10 Preset reference

Table 2.3

Q3-3 Closed Loop Settings
1-00 Configuration mode
20-00 Feedback 1 Source

Q3-3 Closed Loop Settings
20-12 Reference/Feedback Unit
6-20 Term 54 low voltage
6-21 Term 54 high voltage
6-22 Terminal 54 Low Current (only visible if switch set to I)
6-23 Terminal 54 High Current (only visible if switch set to I)
6-24 Terminal 54 Low ref / Feedb. value
6-25 Terminal 54 High ref / Feedb. value
3-02 Min. Reference
3-03 Max. Reference
20-21 Setpoint 1
20-93 PID Proportional Gain
20-94 PID Integral Time
3-13 Reference site

Table 2.4

Q3-4 Application Settings		
Compressor	Condenser	Single fan/ pump
22-75 Short Cycle Protection	22-40 Minimum run time	22-40 Minimum run time
22-76 Interval between Starts	22-41 Minumum sleep time	22-41 Minumum sleep time
22-77 Minimum Run Time	22-42 Wake-up Speed [RPM]	22-42 Wake-up Speed [RPM]
20-00 Feedback 1 Source	22-43 Wake-up Speed [Hz]	22-43 Wake-up Speed [Hz]
20-01 Feedback 1 Conversion	22-44 Wake up ref. /FB difference	22-44 Wake up ref. /FB difference
20-02 Feedback 1 Source Unit	20-00 Feedback 1 Source	
20-30 Refrigerant	20-01 Feedback 1 Conversion	
20-40 ThermostatPressostat	20-02 Feedback 1 Source Unit	
20-41 Cut-out value	20-30 Refrigerant	
20-42 Cut-in value	20-40 ThermostatPressostat	
25-00 Pack Controller	20-41 Cut-out value	
25-06 Number of compressors	20-42 Cut-in value	
25-20 Neutral zone		
25-21 +zone		
25-22 -zone		

Table 2.5

2

2.1.7 Main Menu Mode

Select the Main Menu mode by pressing the [Main Menu] key. Illustration 6.2 shows the resulting read-out, which appears on the display of the GLCP. Lines 2 through 5 on the display show a list of parameter groups which can be chosen by toggling the up and down buttons.

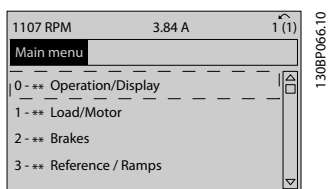

Illustration 2.27 Display example.

Each parameter has a name and number which remain the same regardless of the programming mode. In the Main Menu mode, the parameters are divided into groups. The first digit of the parameter number (from the left) indicates the parameter group number.

All parameters can be changed in the Main Menu. The configuration of the unit (*1-00 Configuration Mode*) will determine other parameters available for programming. For example, selecting Closed Loop enables additional parameters related to closed loop operation. Option cards added to the unit enable additional parameters associated with the option device.

2.1.8 Parameter Selection

In the Main Menu mode, the parameters are divided into groups. Select a parameter group by means of the navigation keys. The following parameter groups are accessible:

Group no.	Parameter group
0-**	Operation/Display
1-**	Load/Motor
2-**	Brakes
3-**	References/Ramps
4-**	Limits/Warnings
5-**	Digital In/Out
6-**	Analog In/Out
8-**	Comm. and Options
11-**	LonWorks
13-**	Smart Logic
14-**	Special Functions
15-**	Drive Information
16-**	Data Readouts
18-**	Info & Readouts
20-**	Drive Closed Loop

Group no.	Parameter group
21-**	Ext. Closed Loop
22-**	Application Functions
23-**	Time-based Functions
25-**	Pack Controller
26-**	Analog I/O Option
28-**	Compressor Functions

Table 2.6 Parameter groups.

After selecting a parameter group, choose a parameter by means of the navigation keys. The middle section on the GLCP display shows the parameter number and name as well as the selected parameter value.

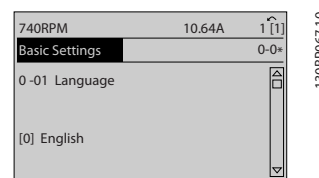

Illustration 2.28 Display example.

2.1.9 Changing Data

The procedure for changing data is the same in the Quick menu and the Main menu mode. Press [OK] to change the selected parameter. The procedure for changing data depends on whether the selected parameter represents a numerical data value or a text value.

2.1.10 Changing a Text Value

If the selected parameter is a text value, change the text value with the [▲] [▼] keys. Place the cursor on the value to save and press [OK].

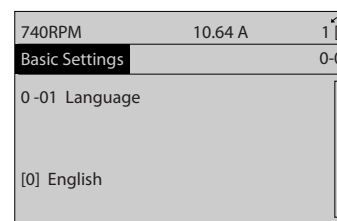

Illustration 2.29

2.1.11 Changing a Group of Numeric Data Values

If the chosen parameter represents a numeric data value, change the chosen data value by means of the [◀] [▶] navigation keys as well as the [▲] [▼] navigation keys. Press [◀] [▶] keys to move the cursor horizontally.

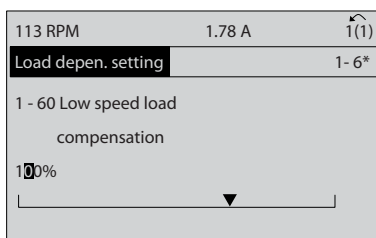

Illustration 2.30

Press [▲] [▼] keys to change the data value. [▲] increases the data value, and [▼] decreases the data value. Place the cursor on the value to save and press [OK].

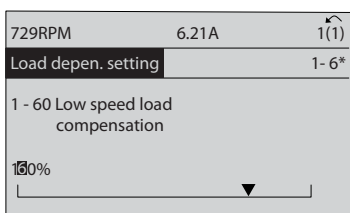

Illustration 2.31

2.1.12 Value, Step-by-Step

Certain parameters can be changed step by step or infinitely varying. This applies to 1-20 Motor Power [kW], 1-22 Motor Voltage and 1-23 Motor Frequency. The parameters are changed both as a group of numeric data values and as numeric data values infinitely varying.

2.1.13 Read-out and Programming of Indexed Parameters

Parameters are indexed when placed in a rolling stack. 15-30 Alarm Log: Error Code to 15-33 Alarm Log: Date and Time contain a fault log which can be read out. Choose a parameter, press [OK], and use the up/down navigation keys to scroll through the value log.

Use 3-10 Preset Reference as another example: Choose the parameter, press [OK], and use the up/down navigation keys to scroll through the indexed values. To change the parameter value, select the indexed value and press [OK]. Change the value by using the up/down

keys. Press [OK] to accept the new setting. Press [Cancel] to abort. Press [Back] to leave the parameter.

2.1.14 Initialisation to Default Settings

Initialise the frequency converter to default settings in two ways.

Recommended initialisation (via 14-22 Operation Mode)

1. Select 14-22 Operation Mode
2. Press [OK]
3. Select "initialisation"
4. Press [OK]
5. Cut off the mains supply and wait until the display turns off.
6. Reconnect the mains supply - the frequency converter is now reset.
7. Change 14-22 Operation Mode back to Normal Operation.

NOTE

Resets parameters selected in Personal Menu with default factory setting.

- 14-22 Operation Mode initialises all except
- 14-50 RFI Filter
- 8-30 Protocol
- 8-31 Address
- 8-32 Baud Rate
- 8-35 Minimum Response Delay
- 8-36 Maximum Response Delay
- 8-37 Maximum Inter-Char Delay
- 15-00 Operating hours to 15-05 Over Volt's
- 15-20 Historic Log: Event to 15-22 Historic Log: Time
- 15-30 Alarm Log: Error Code to 15-32 Alarm Log: Time

Manual initialisation

1.	Disconnect from mains and wait until the display turns off.
2a.	Press [Status] - [Main Menu] - [OK] at the same time while power up for LCP 102, Graphical Display
2b.	Press [Menu] while power up for LCP 101, Numerical Display
3.	Release the keys after 5 seconds
4.	The frequency converter is now programmed according to default settings.
This procedure initialises all except: <i>15-00 Operating hours; 15-03 Power Up's; 15-04 Over Temp's; 15-05 Over Volt's.</i>	

Table 2.7

NOTE

When you carry out manual initialisation, you also reset serial communication, *14-50 RFI Filter* and fault log settings. Removes parameters selected in *25-00 Pack Controller*.

NOTE

After initialisation and power cycling, the display will not show any information until after a couple of minutes.

3 Parameter Description

3.1 Parameter Selection

3.1.1 Main Menu Structure

Parameters for the frequency converter are grouped into various parameter groups for easy selection of the correct parameters for optimised operation of the frequency converter.

The vast majority of FC 103 applications can be programmed pressing [Quick Menu] and selecting the parameters under Quick Setup and Function Setups. Descriptions and default settings of parameters can be found in 4 *Parameter Lists*.

- 0-** Operation/Display
- 1-** Load and Motor
- 2-** Brakes
- 3-** Reference/Ramps
- 4-** Limits/Warnings
- 5-** Digital In/Out
- 6-** Analog In/Out
- 8-** Comm. and Options
- 11-** LonWorks
- 13-** Smart Logic
- 14-** Special Functions
- 15-** Drive Information
- 16-** Data Readouts
- 18-** Info & Readouts
- 20-** Drive Closed Loop
- 21-** Ext. Closed Loop
- 22-** Appl. Functions
- 23-** Time-based Functions
- 25-** Pack Controller
- 26-** Analog I/O Option
- 28-** Compressor Functions

3.2 Main Menu - Operation and Display - Group 0

Parameters related to the fundamental functions of the frequency converter, function of the LCP keys and configuration of the LCP display.

0-01 Language		
Option:		Function:
		Defines the language to be used in the display. The frequency converter can be delivered with 2 different language packages. English and German are included in both packages. English cannot be erased or manipulated.
[0] *	English	Part of Language packages 1 - 2
[1]	Deutsch	Part of Language packages 1 - 2
[2]	Francais	Part of Language package 1
[3]	Dansk	Part of Language package 1
[4]	Spanish	Part of Language package 1
[5]	Italiano	Part of Language package 1
[6]	Svenska	Part of Language package 1
[7]	Nederlands	Part of Language package 1
[10]	Chinese	Language package 2
[20]	Suomi	Part of Language package 1
[22]	English US	Part of Language package 1
[27]	Greek	Part of Language package 1
[28]	Bras.port	Part of Language package 1
[36]	Slovenian	Part of Language package 1
[39]	Korean	Part of Language package 2
[40]	Japanese	Part of Language package 2
[41]	Turkish	Part of Language package 1
[42]	Trad.Chinese	Part of Language package 2
[43]	Bulgarian	Part of Language package 1
[44]	Srpski	Part of Language package 1
[45]	Romanian	Part of Language package 1
[46]	Magyar	Part of Language package 1
[47]	Czech	Part of Language package 1
[48]	Polski	Part of Language package 1
[49]	Russian	Part of Language package 1
[50]	Thai	Part of Language package 2

0-01 Language		
Option:	Function:	
[51]	Bahasa Indonesia	Part of Language package 2

0-02 Motor Speed Unit		
Option:	Function:	
		The display showing depends on settings in <i>0-02 Motor Speed Unit</i> and <i>0-03 Regional Settings</i> . The default setting of <i>0-02 Motor Speed Unit</i> and <i>0-03 Regional Settings</i> depends on which region of the world the frequency converter is supplied to, but can be re-programmed as required. NOTE Changing the <i>Motor Speed Unit</i> will reset certain parameters to their initial value. It is recommended to select the motor speed unit first, before modifying other parameters.
[0]	RPM	Selects display of motor speed variables and parameters (i.e. references, feedbacks and limits) in terms of motor speed (RPM).
[1] *	Hz	Selects display of motor speed variables and parameters (i.e. references, feedbacks and limits) in terms of output frequency to the motor (Hz).

NOTE

This parameter cannot be adjusted while the motor is running.

0-03 Regional Settings		
Option:	Function:	
		This parameter cannot be adjusted while the motor is running. The display showing depends on settings in <i>0-02 Motor Speed Unit</i> and <i>0-03 Regional Settings</i> . The default setting of <i>0-02 Motor Speed Unit</i> and <i>0-03 Regional Settings</i> depends on which region of the world the frequency converter is supplied to but can be re-programmed as required.
[0]	International	Sets <i>1-20 Motor Power [kW]</i> units to [kW] and the default value of <i>1-23 Motor Frequency</i> [50 Hz].
[1] *	North America	Sets <i>1-21 Motor Power [HP]</i> units to HP and the default value of <i>1-23 Motor Frequency</i> to 60 Hz.

The settings not used are made invisible.

0-04 Operating State at Power-up		
Option:	Function:	
		Select the operating mode upon reconnection of the frequency converter to mains voltage after power down when operating in Hand (local) mode.

0-04 Operating State at Power-up		
Option:	Function:	
[0] *	Resume	Resumes operation of the frequency converter maintaining the same local reference and the same start/stop condition (applied by [Hand On]/[Off] on the LCP or Hand Start via a digital input as before the frequency converter was powered down.
[1]	Forced stop, ref=old	Uses [1] <i>Forced stop, ref=old</i> to stop the frequency converter but at the same time retain in memory the local speed reference prior to power down. After mains voltage is reconnected and after receiving a start command (pressing [Hand On] or Hand Start command via a digital input) the frequency converter restarts and operates at the retained speed reference.

0-05 Local Mode Unit		
Option:	Function:	
		Defines if the local reference unit should be displayed in terms of the motor shaft speed (in RPM/Hz) or as percent.
[0]	As Motor Speed Unit	
[1]	%	

3.2.1 0-1* Set-up Operations

Define and control the individual parameter set-ups. The frequency converter has four parameter setups that can be programmed independently of each other. This makes the frequency converter very flexible and able to meet the requirements of many different VLT Refrigeration Drive system control schemes often saving the cost of external control equipment. For example these can be used to program the frequency converter to operate according to one control scheme in one setup (e.g. daytime operation) and another control scheme in another setup (e.g. night set back). Alternatively they can be used by an AHU or packaged unit OEM to identically program all their factory fitted frequency converters for different equipment models within a range to have the same parameters and then during production/commissioning simply select a specific setup depending on which model within that range the frequency converter is installed on. The active setup (i.e. the setup in which the frequency converter is currently operating) can be selected in parameter 0-10 and is displayed in the LCP. Using Multi set-up it is possible to switch between set-ups with the frequency converter running or stopped, via digital input or serial communication commands (e.g. for night set back). If it is necessary to change setups whilst running, ensure *0-12 This Set-up Linked to* is programmed as required. For the majority of VLT Refrigeration Drive applications it will not be necessary to program *0-12 This*

Set-up Linked to even if change of set up whilst running is required, but for very complex applications, using the full flexibility of the multiple setups, it may be required. Using 0-11 Programming Set-up it is possible to edit parameters within any of the setups whilst continuing the frequency converter operation in its Active Setup which can be a different setup to that being edited. Using 0-51 Set-up Copy it is possible to copy parameter settings between the set-ups to enable quicker commissioning if similar parameter settings are required in different set-ups.

0-10 Active Set-up		
Option:	Function:	
		Select the set-up in which the frequency converter is to operate. Use 0-51 Set-up Copy to copy a set-up to one or all other set-ups. To avoid conflicting settings of the same parameter within two different set-ups, link the set-ups together using 0-12 This Set-up Linked to. Stop the frequency converter before switching between set-ups where parameters marked 'not changeable during operation' have different values. Parameters which are 'not changeable during operation' are marked FALSE in 4 Parameter Lists.
[0]	Factory setup	Cannot be changed. It contains the Danfoss data set, and can be used as a data source when returning the other set-ups to a known state.
[1] *	Set-up 1	[1] Set-up 1 to [4] Set-up 4 are the four parameter set-ups within which all parameters can be programmed.
[2]	Set-up 2	
[3]	Set-up 3	
[4]	Set-up 4	
[9]	Multi Set-up	Is used for remote selection of set-ups using digital inputs and the serial communication port. This set-up uses the settings from 0-12 This Set-up Linked to.

0-11 Programming Set-up		
Option:	Function:	
		Select the set-up to be edited (i.e. programmed) during operation; either the active set-up or one of the inactive set-ups. The set-up number being edited is displayed in the LCP in (brackets).
[0]	Factory setup	Cannot be edited but it is useful as a data source to return the other set-ups to a known state.
[1]	Set-up 1	[1] Set-up 1 to [4] Set-up 4 can be edited freely during operation, independently of the active set-up.

0-11 Programming Set-up		
Option:	Function:	
[2]	Set-up 2	
[3]	Set-up 3	
[4]	Set-up 4	
[9] *	Active Set-up	(i.e. the set-up in which the frequency converter is operating) can also be edited during operation. Editing parameters in the chosen set-up would normally be done from the LCP, but it is also possible from any of the serial communication ports.

0-12 This Set-up Linked to		
Option:	Function:	
		<p>This parameter only needs to be programmed if changing set-ups is required whilst the motor is running. It ensures that parameters which are "not changeable during operation" have the same setting in all relevant set-ups.</p> <p>To enable conflict-free changes from one set-up to another whilst the frequency converter is running, link set-ups containing parameters which are not changeable during operation. The link will ensure synchronising of the 'not changeable during operation' parameter values when moving from one set-up to another during operation. 'Not changeable during operation' parameters can be identified by the label FALSE in the parameter lists in 4 Parameter Lists.</p> <p>The 0-12 This Set-up Linked to feature is used when Multi set-up in 0-10 Active Set-up is selected. Multi set-up can be used to move from one set-up to another during operation (i.e. while the motor is running).</p> <p>Example:</p> <p>Use Multi set-up to shift from Set-up 1 to Set-up 2 whilst the motor is running. Programme parameters in Set-up 1 first, then ensure that Set-up 1 and Set-up 2 are synchronised (or 'linked'). Synchronisation can be performed in two ways:</p> <ol style="list-style-type: none"> 1. Change the edit set-up to [2] Set-up 2 in 0-11 Programming Set-up and set 0-12 This Set-up Linked to to [1] Set-up 1. This will start the linking (synchronising) process.

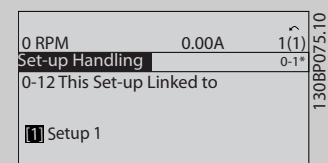
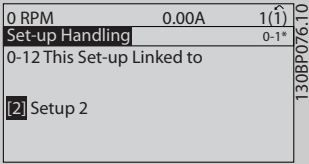

Illustration 3.1

0-12 This Set-up Linked to	
Option:	Function:
	<p>OR</p> <p>2. While still in Set-up 1, using 0-50 LCP Copy, copy Set-up 1 to Set-up 2. Then set 0-12 This Set-up Linked to to [2] Set-up 2. This will start the linking process.</p>  <p>Illustration 3.2</p> <p>After the link is complete, 0-13 Readout: Linked Set-ups will read {1,2} to indicate that all 'not changeable during operation' parameters are now the same in Set-up 1 and Set-up 2. If there are changes to a 'not changeable during operation' parameter, e.g. 1-30 Stator Resistance (Rs), in Set-up 2, they will also be changed automatically in Set-up 1. A switch between Set-up 1 and Set-up 2 during operation is now possible.</p>
[0] *	Not linked
[1]	Set-up 1
[2]	Set-up 2
[3]	Set-up 3
[4]	Set-up 4

0-13 Readout: Linked Set-ups													
Array [5]													
Range:	Function:												
0 *	<p>[0 - 255] View a list of all the set-ups linked by means of 0-12 This Set-up Linked to. The parameter has one index for each parameter set-up. The parameter value displayed for each index represents which set-ups are linked to that parameter set-up.</p> <table border="1" data-bbox="316 1619 769 1823"> <thead> <tr> <th>Index</th> <th>LCP value</th> </tr> </thead> <tbody> <tr> <td>0</td> <td>{0}</td> </tr> <tr> <td>1</td> <td>{1,2}</td> </tr> <tr> <td>2</td> <td>{1,2}</td> </tr> <tr> <td>3</td> <td>{3}</td> </tr> <tr> <td>4</td> <td>{4}</td> </tr> </tbody> </table> <p>Table 3.2 Example: Set-up 1 and Set-up 2 are linked</p>	Index	LCP value	0	{0}	1	{1,2}	2	{1,2}	3	{3}	4	{4}
Index	LCP value												
0	{0}												
1	{1,2}												
2	{1,2}												
3	{3}												
4	{4}												

0-14 Readout: Prog. Set-ups / Channel	
Range:	Function:
0 *	<p>[-2147483648 - 2147483647] View the setting of 0-11 Programming Set-up for each of the four different</p>

0-14 Readout: Prog. Set-ups / Channel	
Range:	Function:
	<p>communication channels. When the number is displayed in hex, as it is in the LCP, each number represents one channel. Numbers 1-4 represent a set-up number; 'F' means factory setting; and 'A' means active set-up. The channels are, from right to left: LCP, FC-bus, USB, HPFB1.5.</p> <p>Example: The number AAAAAA21h means that the FC-bus selected Set-up 2 in 0-11 Programming Set-up, the LCP selected Set-up 1 and all others used the active set-up.</p>

3.2.2 0-2* LCP Display

Define the variables displayed in the Graphical Local Control Panel.

NOTE

Please refer to 0-37 Display Text 1, 0-38 Display Text 2 and 0-39 Display Text 3 for information on how to write display texts.

0-20 Display Line 1.1 Small		
Option:		Function:
		Select a variable for display in line 1, left position. Default setting is application dependent.
[37]	Display Text 1	Enables an individual text string to be written, for display in the LCP or to be read via serial communication.
[38]	Display Text 2	Enables an individual text string to be written, for display in the LCP or to be read via serial communication.
[39]	Display Text 3	Enables an individual text string to be written, for display in the LCP or to be read via serial communication.
[89]	Date and Time Readout	Displays the current date and time.
[953]	Profibus Warning Word	Displays Profibus communication warnings.
[1005]	Readout Transmit Error Counter	View the number of CAN control transmission errors since the last power-up.
[1006]	Readout Receive Error Counter	View the number of CAN control receipt errors since the last power-up.

0-20 Display Line 1.1 Small		
Option:	Function:	
[1007]	Readout Bus Off Counter	View the number of Bus Off events since the last power-up.
[1013]	Warning Parameter	View a DeviceNet-specific warning word. One sete bit is assigned to every warning.
[1501]	Running Hours	View the number of running hours of the motor.
[1502]	kWh Counter	View the mains power consumption in kWh.
[1600]	Control Word	View the Control Word sent from the frequency converter via the serial communication port in hex code.
[1601]	Reference [Unit]	Total reference (sum of digital/analog/preset/bus/freeze ref./catch up and slow-down) in selected unit.
[1602]	Reference [%]	Total reference (sum of digital/analog/preset/bus/freeze ref./catch up and slow-down) in percent.
[1603]	Status Word	Present status word
[1605]	Main Actual Value [%]	View the two-byte word sent with the Status word to the bus Master reporting the Main Actual Value.
[1609]	Custom Readout	View the user-defined readouts as defined in <i>0-30 Custom Readout Unit</i> , <i>0-31 Custom Readout Min Value</i> and <i>0-32 Custom Readout Max Value</i> .
[1610]	Power [kW]	Actual power consumed by the motor in kW.
[1611]	Power [hp]	Actual power consumed by the motor in HP.
[1612]	Motor Voltage	Voltage supplied to the motor.
[1613]	Frequency	Motor frequency, i.e. the output frequency from the frequency converter in Hz.
[1614]	Motor current	Phase current of the motor measured as effective value.
[1615]	Frequency [%]	Motor frequency, i.e. the output frequency from the frequency converter in percent.
[1616]	Torque [Nm]	Present motor load as a percentage of the rated motor torque.
[1617]	Speed [RPM]	Motor speed reference. Actual speed will depend on slip compensation being used (compensation set in <i>1-62 Slip Compensation</i>). If not used, actual speed will be the value

0-20 Display Line 1.1 Small		
Option:	Function:	
		read in the display minus motor slip.
[1618]	Motor Thermal	Thermal load on the motor, calculated by the ETR function. See also parameter group 1-9* Motor Temperature.
[1622]	Torque [%]	Shows the actual torque produced, in percentage.
[1630]	DC Link Voltage	Intermediate circuit voltage in the frequency converter.
[1632]	Brake Energy /s	Present brake power transferred to an external brake resistor. Stated as an instantaneous value.
[1633]	Brake Energy /2 min	Brake power transferred to an external brake resistor. The mean power is calculated continuously for the most recent 120 seconds.
[1634]	Heatsink Temp.	Present heat sink temperature of the frequency converter. The cut-out limit is $95 \pm 5^\circ \text{C}$; cutting back in occurs at $70 \pm 5^\circ \text{C}$.
[1635]	Inverter Thermal	Percentage load of the inverters
[1636]	Inv. Nom. Current	Nominal current of the frequency converter
[1637]	Inv. Max. Current	Maximum current of the frequency converter
[1638]	SL Controller State	State of the event executed by the control
[1639]	Control Card Temp.	Temperature of the control card.
[1650]	External Reference	Sum of the external reference as a percentage, i.e. the sum of analog/pulse/bus.
[1652]	Feedback[Unit]	Reference value from programmed digital input(s).
[1653]	Digi Pot Reference	View the contribution of the digital potentiometer to the actual reference Feedback.
[1654]	Feedback 1 [Unit]	View the value of Feedback 1. See also 20-0*.
[1655]	Feedback 2 [Unit]	View the value of Feedback 2. See also 20-0*.
[1656]	Feedback 3 [Unit]	View the value of Feedback 3. See also parameter group 20-0*.
[1660]	Digital Input	Displays the status of the digital inputs. Signal low = 0; Signal high = 1. Regarding order, see <i>16-60 Digital Input</i> . Bit 0 is at the extreme right.

0-20 Display Line 1.1 Small		
Option:	Function:	
[1661]	Terminal 53 Switch Setting	Setting of input terminal 53. Current = 0; Voltage = 1.
[1662]	Analog Input 53	Actual value at input 53 either as a reference or protection value.
[1663]	Terminal 54 Switch Setting	Setting of input terminal 54. Current = 0; Voltage = 1.
[1664]	Analog Input 54	Actual value at input 54 either as reference or protection value.
[1665]	Analog Output 42 [mA]	Actual value at output 42 in mA. Use 6-50 Terminal 42 Output to select the variable to be represented by output 42.
[1666]	Digital Output [bin]	Binary value of all digital outputs.
[1667]	Pulse Input #29 [Hz]	Actual value of the frequency applied at terminal 29 as a pulse input.
[1668]	Pulse Input #33 [Hz]	Actual value of the frequency applied at terminal 33 as a pulse input.
[1669]	Pulse Output #27 [Hz]	Actual value of pulses applied to terminal 27 in digital output mode.
[1670]	Pulse Output #29 [Hz]	Actual value of pulses applied to terminal 29 in digital output mode.
[1671]	Relay Output [bin]	View the setting of all relays.
[1672]	Counter A	View the present value of Counter A.
[1673]	Counter B	View the present value of Counter B.
[1675]	Analog In X30/11	Actual value of the signal on input X30/11 (General Purpose I/O Card. Option)
[1676]	Analog In X30/12	Actual value of the signal on input X30/12 (General Purpose I/O Card. Optional)
[1677]	Analog Out X30/8 [mA]	Actual value at output X30/8 (General Purpose I/O Card. Optional) Use Par. 6-60 to select the variable to be shown.
[1680]	Fieldbus CTW 1	Control word (CTW) received from the Bus Master.
[1682]	Fieldbus REF 1	Main reference value sent with control word via the serial communications network e.g. from the BMS, PLC or other master controller.
[1684]	Comm. Option STW	Extended fieldbus communication option status word.

0-20 Display Line 1.1 Small		
Option:	Function:	
[1685]	FC Port CTW 1	Control word (CTW) received from the Bus Master.
[1686]	FC Port REF 1	Status word (STW) sent to the Bus Master.
[1690]	Alarm Word	One or more alarms in a Hex code (used for serial communications)
[1691]	Alarm Word 2	One or more alarms in a Hex code (used for serial communications)
[1692]	Warning Word	One or more warnings in a Hex code (used for serial communications)
[1693]	Warning Word 2	One or more warnings in a Hex code (used for serial communications)
[1694]	Ext. Status Word	One or more status conditions in a Hex code (used for serial communications)
[1695]	Ext. Status Word 2	One or more status conditions in a Hex code (used for serial communications)
[1696]	Maintenance Word	The bits reflect the status for the programmed Preventive Maintenance Events in parameter group 23-1*
[1830]	Analog Input X42/1	Shows the value of the signal applied to terminal X42/1 on the Analog I/O card.
[1831]	Analog Input X42/3	Shows the value of the signal applied to terminal X42/3 on the Analog I/O card.
[1832]	Analog Input X42/5	Shows the value of the signal applied to terminal X42/5 on the Analog I/O card.
[1833]	Analog Out X42/7 [V]	Shows the value of the signal applied to terminal X42/7 on the Analog I/O card.
[1834]	Analog Out X42/9 [V]	Shows the value of the signal applied to terminal X42/9 on the Analog I/O card.
[1835]	Analog Out X42/11 [V]	Shows the value of the signal applied to terminal X42/11 on the Analog I/O card.
[2117]	Ext. 1 Reference [Unit]	The value of the reference for extended Closed Loop Controller 1
[2118]	Ext. 1 Feedback [Unit]	The value of the feedback signal for extended Closed Loop Controller 1
[2119]	Ext. 1 Output [%]	The value of the output from extended Closed Loop Controller 1

0-20 Display Line 1.1 Small		
Option:	Function:	
[2137]	Ext. 2 Reference [Unit]	The value of the reference for extended Closed Loop Controller 2
[2138]	Ext. 2 Feedback [Unit]	The value of the feedback signal for extended Closed Loop Controller 2
[2139]	Ext. 2 Output [%]	The value of the output from extended Closed Loop Controller 2
[2157]	Ext. 3 Reference [Unit]	The value of the reference for extended Closed Loop Controller 3
[2158]	Ext. 3 Feedback [Unit]	The value of the feedback signal for extended Closed Loop Controller 3
[2159]	Ext. 3 Output [%]	The value of the output from extended Closed Loop Controller 3
[2230]	No-Flow Power	The calculated No Flow Power for the actual operating speed
[2316]	Maintenance Text	
[2580]	Pack Status	Status for the operation of the Cascade Controller
[2581]	Compressor Status	Status for the operation of each individual pump controlled by the Cascade Controller
[2587]	Inverse Interlock	
[2588]	Pack capacity [%]	
[2827]	Discharge Temperature	
[3110]	Bypass Status Word	
[3111]	Bypass Running Hours	

0-21 Display Line 1.2 Small		
Option:	Function:	
Application Dependent	Select a variable for display in line 1, middle position. The options are the same as listed for 0-20 Display Line 1.1 Small.	

0-22 Display Line 1.3 Small		
Option:	Function:	
Application Dependent	Select a variable for display in line 1, right position. The options are the same as listed for 0-20 Display Line 1.1 Small.	

0-23 Display Line 2 Large		
Option:	Function:	
Application Dependent	Select a variable for display in line 2. The options are the same as listed for 0-20 Display Line 1.1 Small.	

0-24 Display Line 3 Large		
Option:	Function:	
Application Dependent	Select a variable for display in line 3. The options are the same as listed for 0-20 Display Line 1.1 Small.	

0-25 My Personal Menu		
Array [20]		
Range:	Function:	
Size related* [0 - 9999]	Define up to 20 parameters to appear in the Q1 Personal Menu, accessible via the [Quick Menu] key on the LCP. The parameters will be displayed in the Q1 Personal Menu in the order they are programmed into this array parameter. Delete parameters by setting the value to '0000'. For example, this can be used to provide quick, simple access to just one or up to 20 parameters which require changing on a regular basis (e.g. for plant maintenance reasons) or by an OEM to enable simple commissioning of their equipment.	

3.2.3 0-3* LCP Custom Readout

It is possible to customize the display elements for various purposes: *Custom Readout. Value proportional to speed (Linear, squared or cubed depending on unit selected in 0-30 Custom Readout Unit) *Display Text. Text string stored in a parameter.

Custom Readout

The calculated value to be displayed is based on settings in 0-30 Custom Readout Unit, 0-31 Custom Readout Min Value (linear only), 0-32 Custom Readout Max Value, 4-13 Motor Speed High Limit [RPM], 4-14 Motor Speed High Limit [Hz] and actual speed.

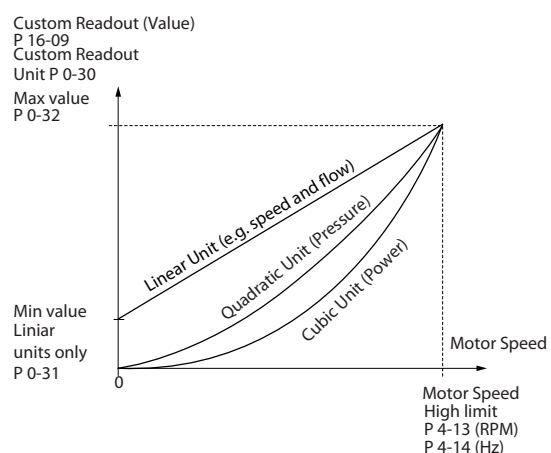

Illustration 3.3

The relation will depend on the type of unit selected in 0-30 Custom Readout Unit:

Unit Type	Speed Relation
Dimensionless	Linear
Speed	
Flow, volume	
Flow, mass	
Velocity	
Length	
Temperature	
Pressure	Quadratic
Power	Cubic

Table 3.3

0-30 Custom Readout Unit		
Option:	Function:	
	Program a value to be shown in the display of the LCP. The value has a linear, squared or cubed relation to speed. This relation depends on the unit selected (see Table 3.3). The actual calculated value can be read in 16-09 Custom Readout, and/or shown in the display by selecting [1609 Custom Readout] in 0-20 Display Line 1.1 Small to 0-24 Display Line 3 Large.	
[0]		
[1] *	%	
[5]	PPM	
[10]	1/min	
[11]	RPM	
[12]	Pulse/s	
[20]	l/s	
[21]	l/min	
[22]	l/h	
[23]	m ³ /s	
[24]	m ³ /min	
[25]	m ³ /h	
[30]	kg/s	
[31]	kg/min	
[32]	kg/h	
[33]	t/min	
[34]	t/h	
[40]	m/s	
[41]	m/min	
[45]	m	
[60]	°C	
[70]	mbar	
[71]	bar	
[72]	Pa	
[73]	kPa	
[74]	m WG	
[80]	kW	
[120]	GPM	
[121]	gal/s	

0-30 Custom Readout Unit		
Option:	Function:	
[122]	gal/min	
[123]	gal/h	
[124]	CFM	
[125]	ft ³ /s	
[126]	ft ³ /min	
[127]	ft ³ /h	
[130]	lb/s	
[131]	lb/min	
[132]	lb/h	
[140]	ft/s	
[141]	ft/min	
[145]	ft	
[160]	°F	
[170]	psi	
[171]	lb/in ²	
[172]	in WG	
[173]	ft WG	
[180]	HP	

0-31 Custom Readout Min Value		
Range:	Function:	
Size related*	[0 - 0 Custom-ReadoutUnit]	This parameter allows the choice of the min. value of the custom defined readout (occurs at zero speed). It is only possible to select a value different to 0 when selecting a linear unit in 0-30 Custom Readout Unit. For Quadratic and Cubic units the minimum value will be 0.

0-32 Custom Readout Max Value		
Range:	Function:	
100 CustomReadoutUnit*	[par. 0-31 - 999999.99 CustomReadoutUnit]	This parameter sets the max value to be shown when the speed of the motor has reached the set value for 4-13 Motor Speed High Limit [RPM] or 4-14 Motor Speed High Limit [Hz] (depends on setting in 0-02 Motor Speed Unit).

0-37 Display Text 1		
Range:	Function:	
0 * [0 - 0]	In this parameter it is possible to write an individual text string for display in the LCP or to be read via serial communication. If to be displayed permanently select Display Text 1 in <i>0-20 Display Line 1.1 Small</i> , <i>0-21 Display Line 1.2 Small</i> , <i>0-22 Display Line 1.3 Small</i> , <i>0-23 Display Line 2 Large</i> or <i>0-24 Display Line 3 Large</i> . Press [▲] or [▼] to change a character. Press [◀] and [▶] to move the cursor. When a character is highlighted by the cursor, it can be changed. Press [▲] or [▼] to change a character. A character can be inserted by placing the cursor between two characters and pressing [▲] or [▼].	

0-38 Display Text 2		
Range:	Function:	
0 * [0 - 0]	In this parameter it is possible to write an individual text string for display in the LCP or to be read via serial communication. If to be displayed permanently select Display Text 2 in <i>0-20 Display Line 1.1 Small</i> , <i>0-21 Display Line 1.2 Small</i> , <i>0-22 Display Line 1.3 Small</i> , <i>0-23 Display Line 2 Large</i> or <i>0-24 Display Line 3 Large</i> . Press [▲] or [▼] to change a character. Press [◀] and [▶] to move the cursor. When a character is highlighted by the cursor, this character can be changed. A character can be inserted by placing the cursor between two characters and pressing [▲] or [▼].	

0-39 Display Text 3		
Range:	Function:	
0 * [0 - 0]	In this parameter it is possible to write an individual text string for display in the LCP or to be read via serial communication. If to be displayed permanently select Display Text 3 in <i>0-20 Display Line 1.1 Small</i> , <i>0-21 Display Line 1.2 Small</i> , <i>0-22 Display Line 1.3 Small</i> , <i>0-23 Display Line 2 Large</i> or <i>0-24 Display Line 3 Large</i> . Press [▲] or [▼] to change a character. Press [◀] and [▶] to move the cursor. When a character is highlighted by the cursor, this character can be changed. A character can be inserted by placing the cursor between two characters and pressing [▲] or [▼].	

0-40 [Hand on] Key on LCP		
Option:	Function:	
[0]	Disabled	Key disabled avoids accidental usage of the key.
[1] *	Enabled	[Hand On] key enabled
[2]	Password	Avoid unauthorized start in Hand mode. If <i>0-40 [Hand on] Key on LCP</i> is included in the My Personal Menu, then define the password in <i>0-65 Personal Menu Password</i> . Otherwise define the password in <i>0-60 Main Menu Password</i> .

0-41 [Off] Key on LCP		
Option:	Function:	
[0]	Disabled	Key disabled avoids accidental usage of the key.
[1] *	Enabled	[Off] key is enabled
[2]	Password	Avoid unauthorized stop. If <i>0-41 [Off] Key on LCP</i> is included in the My Personal Menu, then define the password in <i>0-65 Personal Menu Password</i> . Otherwise define the password in <i>0-60 Main Menu Password</i> .

0-42 [Auto on] Key on LCP		
Option:	Function:	
[0]	Disabled	Key disabled avoids accidental usage of the key.
[1] *	Enabled	[Auto On] key is enabled
[2]	Password	Avoid unauthorized start in Auto mode. If <i>0-42 [Auto on] Key on LCP</i> is included in the My Personal Menu, then define the password in <i>0-65 Personal Menu Password</i> . Otherwise define the password in <i>0-60 Main Menu Password</i> .

0-43 [Reset] Key on LCP		
Option:	Function:	
[0]	Disabled	Key disabled avoids accidental usage of the key.
[1] *	Enabled	[Reset] key is enabled
[2]	Password	Avoid unauthorized resetting. If <i>0-43 [Reset] Key on LCP</i> is included in the <i>0-25 My Personal Menu</i> , then define the password in <i>0-65 Personal Menu Password</i> . Otherwise define the password in <i>0-60 Main Menu Password</i> .

3.2.4 0-4* LCP Keypad

Enable, disable and password protect individual keys on the LCP.

3.2.5 0-5* Copy/Save

Copy parameter settings between set-ups and to/from the LCP.

0-50 LCP Copy		
Option:	Function:	
[0] *	No copy	No function
[1]	All to LCP	Copies all parameters in all set-ups from the frequency converter memory to the LCP memory. For service purposes it is recommended to copy all parameters to the LCP after commissioning.
[2]	All from LCP	Copies all parameters in all set-ups from the LCP memory to the frequency converter memory.
[3]	Size indep. from LCP	Copies only the parameters that are independent of the motor size. The latter selection can be used to programme several frequency converters with the same function without disturbing motor data which are already set.

This parameter cannot be adjusted while the motor is running.

0-51 Set-up Copy		
Option:	Function:	
[0] *	No copy	No function
[1]	Copy to set-up 1	Copies all parameters in the present Programming Set-up (defined in <i>0-11 Programming Set-up</i>) to Set-up 1.
[2]	Copy to set-up 2	Copies all parameters in the present Programming Set-up (defined in <i>0-11 Programming Set-up</i>) to Set-up 2.
[3]	Copy to set-up 3	Copies all parameters in the present Programming Set-up (defined in <i>0-11 Programming Set-up</i>) to Set-up 3.
[4]	Copy to set-up 4	Copies all parameters in the present Programming Set-up (defined in <i>0-11 Programming Set-up</i>) to Set-up 4.
[9]	Copy to all	Copies the parameters in the present set-up over to each of the set-ups 1 to 4.

3.2.6 0-6* Password

0-60 Main Menu Password		
Range:	Function:	
100 *	[-9999 - 9999]	Define the password for access to the Main Menu via the [Main Menu] key. If <i>0-61 Access to Main Menu w/o Password</i> is set to [0] Full access, this parameter will be ignored.

0-61 Access to Main Menu w/o Password		
Option:	Function:	
[0] *	Full access	Disables password defined in <i>0-60 Main Menu Password</i> .
[1]	LCP: Read only	Prevent unauthorized editing of Main Menu parameters.
[2]	LCP: No access	Prevent unauthorized viewing and editing of Main Menu parameters.
[3]	Bus: Read only	
[4]	Bus: No access	
[5]	All: Read only	
[6]	All: No access	

If [0] Full access is selected then *0-60 Main Menu Password*, *0-65 Personal Menu Password* and *0-66 Access to Personal Menu w/o Password* will be ignored.

0-65 Personal Menu Password		
Range:	Function:	
200 *	[-9999 - 9999]	Define the password for access to the My Personal Menu via the [Quick Menu] key. If <i>0-66 Access to Personal Menu w/o Password</i> is set to [0] Full access, this parameter will be ignored.

0-66 Access to Personal Menu w/o Password		
Option:	Function:	
[0] *	Full access	Disables password defined in <i>0-65 Personal Menu Password</i> .
[1]	LCP: Read only	Prevents unauthorized editing of My Personal Menu parameters.
[2]	LCP: No access	Prevents unauthorized viewing and editing of My Personal Menu parameters.
[3]	Bus: Read only	
[4]	Bus: No access	
[5]	All: Read only	
[6]	All: No access	

If *0-61 Access to Main Menu w/o Password* is set to [0] Full access, this parameter will be ignored.

3.2.7 0-7* Clock Settings

Set the time and date of the internal clock. The internal clock can be used for e.g. Timed Actions, energy log, Trend Analysis, date/time stamps on alarms, Logged data and Preventive Maintenance.

It is possible to program the clock for Daylight Saving Time/summertime, weekly working days/non-working days including 20 exceptions (holidays etc.). Although the clock settings can be set via the LCP, they can also be set along with timed actions and preventative maintenance functions using the MCT 10 software tool.

NOTE

The frequency converter has no back up of the clock function and the set date/time will reset to default (2000-01-01 00:00) after a power down unless a Real Time Clock module with back up is installed. If no module with back up is installed, it is recommended the clock function is only used if the frequency converter is integrated into the BMS using serial communications, with the BMS maintaining synchronization of control equipment clock times. In *0-79 Clock Fault* it is possible to program for a Warning in case clock has not been set properly, e.g. after a power down.

NOTE

If mounting an Analog I/O MCB 109 option card, a battery back-up of the date and time is included.

0-70 Set Date and Time		
Range:	Function:	
Size related*	[0 - 0]	Sets the date and time of the internal clock. The format to be used is set in <i>0-71 Date Format</i> and <i>0-72 Time Format</i> .

0-71 Date Format		
Option:	Function:	
		Sets the date format to be used in the LCP.
[0]	YYYY-MM-DD	
[1]	DD-MM-YYYY	
[2] *	MM/DD/YYYY	

0-72 Time Format		
Option:	Function:	
		Sets the time format to be used in the LCP.
[0]	24 h	
[1] *	12 h	

0-74 DST/Summertime		
Option:	Function:	
		Choose how Daylight Saving Time/Summertime should be handled. For manual DST/Summertime enter the start date and end date in <i>0-76 DST/Summertime Start</i> and <i>0-77 DST/Summertime End</i> .
[0] *	Off	
[2]	Manual	

0-76 DST/Summertime Start		
Range:	Function:	
Size related*	[0 - 0]	Sets the date and time when summertime/DST starts. The date is programmed in the format selected in <i>0-71 Date Format</i> .

0-77 DST/Summertime End		
Range:	Function:	
Size related*	[0 - 0]	Sets the date and time when summertime/DST ends. The date is programmed in the format selected in <i>0-71 Date Format</i> .

0-79 Clock Fault		
Option:	Function:	
		Enables or disables the clock warning, when the clock has not been set or has been reset due to a power-down and no backup is installed. If MCB 109 is installed "enabled" is default
[0] *	Disabled	
[1]	Enabled	

0-81 Working Days		
Array with 7 elements [0] - [6] displayed below parameter number in display. Press OK and step between elements with [▲] and [▼].		
Option:	Function:	
		Set for each weekday if it is a working day or a non-working day. First element of the array is Monday. The working days are used for Timed Actions.
[0] *	No	
[1]	Yes	

0-82 Additional Working Days		
Array with 5 elements [0] - [4] displayed below parameter number in display. Press OK and step between elements with [▲] and [▼].		
Range:	Function:	
Size related*	[0 - 0]	Defines dates for additional working days that normally would be non-working days according to <i>0-81 Working Days</i> .

0-83 Additional Non-Working Days		
Array with 15 elements [0] - [14] displayed below parameter number in display. Press OK and step between elements with [▲] and [▼].		
Range:	Function:	
Size related*	[0 - 0]	Defines dates for additional working days that normally would be non-working days according to <i>0-81 Working Days</i> .

0-89 Date and Time Readout		
Range:	Function:	
0 *	[0 - 0]	Displays the current date and time. The date and time is updated continuously. The clock will not begin counting until a setting different from default has been made in <i>0-70 Set Date and Time</i> .

3.3 Main Menu - Load and Motor - Group 1

3.3.1 1-0* General Settings

Define whether the frequency converter operates in open loop or closed loop.

1-00 Configuration Mode		
Option:	Function:	
[0] * Speed Open Loop	Motor speed is determined by applying a speed reference or by setting desired speed when in Hand Mode. Open Loop is also used if the frequency converter is of a closed loop control system based on an external PID controller providing a speed reference signal as output.	
[3] Process Closed Loop	Motor Speed will be determined by a reference from the built-in PID controller varying the motor speed as of a closed loop control process (e.g. constant pressure or flow). The PID controller must be configured in parameter group 20-** or via the Function Setups accessed by pressing [Quick Menus].	

NOTE

This parameter cannot be changed while the motor is running.

NOTE

When set for Closed Loop, the commands Reversing and Start Reversing will not reverse the direction of the motor.

1-03 Torque Characteristics		
Option:	Function:	
[0] * Compressor CT	For speed control of screw and scroll compressors. Provides a voltage which is optimized for a constant torque load characteristic of the motor in the entire range down to 15 Hz.	
[1] Condenser VT	For speed control of centrifugal pumps and fans. Also to be used when controlling more than one motor from the same frequency converter (e.g. multiple condenser fans or cooling tower fans). Provides a voltage which is optimized for a squared torque load characteristic of the motor.	
[2] Compressor AEO CT	<i>Auto Energy Optimization Compressor</i> . For optimum energy efficient speed control of screw, scroll and piston compressors. Provides a voltage which is optimized for a constant torque load characteristic of the motor in the entire range down to 15 Hz but in addition the AEO feature will adapt the voltage exactly to the current load situation, thereby reducing energy consumption and audible noise from the motor. To obtain optimal	

1-03 Torque Characteristics		
Option:	Function:	
	performance, the motor power factor cos phi must be set correctly. This value is set in <i>14-43 Motor Cosphi</i> . The parameter has a default value which is automatically adjusted when the motor data is programmed. These settings will typically ensure optimum motor voltage but if the motor power factor cos phi requires tuning, an AMA function can be carried out using <i>1-29 Automatic Motor Adaptation (AMA)</i> . It is very rarely necessary to adjust the motor power factor parameter manually.	
[3] Single fan/ pump AEO	<i>Auto Energy Optimization VT</i> . For optimum energy efficient speed control of centrifugal pumps and fans. Provides a voltage which is optimized for a squared torque load characteristic of the motor but in addition the AEO feature will adapt the voltage exactly to the current load situation, thereby reducing energy consumption and audible noise from the motor. To obtain optimal performance, the motor power factor cos phi must be set correctly. This value is set in <i>14-43 Motor Cosphi</i> . The parameter has a default value and is automatically adjusted when the motor data is programmed. These settings will typically ensure optimum motor voltage but if the motor power factor cos phi requires tuning, an AMA function can be carried out using <i>1-29 Automatic Motor Adaptation (AMA)</i> . It is very rarely necessary to adjust the motor power factor parameter manually.	

3.3.2 1-1* Motor Selection

1-10 Motor Construction		
Select the motor construction type.		
Option:	Function:	
[0] * Asynchron	For asynchronous motors.	

NOTE

Motor construction can either be asynchronous or permanent magnet (PM) motor.

3.3.3 1-1* VVC^{plus} PM

1-14 Damping Gain		
Range:	Function:	
120 %*	[0 - 250 %]	The damping gain will stabilize the PM machine in order to run the PM machine smooth and stable. The value of Damping gain will control the dynamic performance

1-14 Damping Gain		
Range:		Function:
		of the PM machine. High damping gain will give high dynamic performance and low damping gain will give low dynamic performance. The dynamic performance is related to the machine data and load type. If the damping gain is too high or low the control will become unstable.
120%*	[0-250%]	

1-15 Low Speed Filter Time Const.		
Range:		Function:
Size related*	[0.01 - 20 s]	High pass-filter damping time constant determines the response time to load steps. Obtain quick control through a short damping time constant. However, if this value is too short, the control gets unstable. This time constant is used below 10% rated speed.
Size related*	[0.01 - 20.00 s]	

1-16 High Speed Filter Time Const.		
Range:		Function:
Size related*	[0.01 - 20 s]	High pass-filter damping time constant determines the response time to load steps. Obtain quick control through a short damping time constant. However, if this value is too short, the control gets unstable. This time constant is used above 10% rated speed.
Size related*	[0.01-20.00 s]	

1-17 Voltage filter time const.		
Range:		Function:
Size related*	[0.001 - 1 s]	Machine Supply Voltage Filter Time constant is used for reducing the influence of high frequency ripples and system resonances in the calculation of machine supply voltage. Without this filter, the ripples in the currents can distort the calculated voltage and affects the stability of the system.
Size related*	[0.001-1.000 s]	

3.3.4 1-2* Motor Data

Parameter group 1-2* comprises input data from the nameplate on the connected motor.

NOTE

Changing the value of these parameters affects the setting of other parameters.

NOTE

1-20 Motor Power [kW], 1-21 Motor Power [HP], 1-22 Motor Voltage and 1-23 Motor Frequency will not have effect when 1-10 Motor Construction = [1] PM, non salient SPM.

1-20 Motor Power [kW]		
Range:		Function:
Size related*	[0.09 - 3000.00 kW]	Enter the nominal motor power in kW according to the motor nameplate data. The default value corresponds to the nominal rated output of the unit. Depending on the choices made in 0-03 Regional Settings, either 1-20 Motor Power [kW] or 1-21 Motor Power [HP] is made invisible.
		NOTE This parameter cannot be adjusted while the motor is running.

1-21 Motor Power [HP]		
Range:		Function:
Size related*	[0.09 - 3000.00 hp]	Enter the nominal motor power in HP according to the motor nameplate data. The default value corresponds to the nominal rated output of the unit. Depending on the choices made in 0-03 Regional Settings, either 1-20 Motor Power [kW] or 1-21 Motor Power [HP] is made invisible.
		NOTE This parameter cannot be adjusted while the motor is running.

1-22 Motor Voltage		
Range:		Function:
Size related*	[10 - 1000 V]	Enter the nominal motor voltage according to the motor nameplate data. The default value corresponds to the nominal rated output of the unit.
		NOTE This parameter cannot be adjusted while the motor is running.

1-23 Motor Frequency		
Range:		Function:
Size related*	[20 - 1000 Hz]	Select the motor frequency value from the motor nameplate data. For 87 Hz operation with 230/400 V motors, set the nameplate data for 230 V/50 Hz. Adapt <i>4-13 Motor Speed High Limit [RPM]</i> and <i>3-03 Maximum Reference</i> to the 87 Hz application.

NOTE

This meter cannot be changed while the motor is running.

1-24 Motor Current		
Range:		Function:
Size related*	[0.10 - 10000.00 A]	Enter the nominal motor current value from the motor nameplate data. This data is used for calculating motor torque, motor thermal protection etc.

NOTE

This parameter cannot be changed while the motor is running.

1-25 Motor Nominal Speed		
Range:		Function:
Size related*	[100 - 60000 RPM]	Enter the nominal motor speed value from the motor nameplate data. This data is used for calculating automatic motor compensations.

NOTE

This parameter cannot be changed while the motor is running.

1-26 Motor Cont. Rated Torque		
Range:		Function:
Size related*	[0.1 - 10000 Nm]	Enter the value from the motor nameplate data. The default value corresponds to the nominal rated output. This parameter is available when <i>1-10 Motor Construction</i> is set to <i>[1] PM, non salient SPM</i> , i.e. the parameter is valid for PM and nonsalient SPM motors only.

1-28 Motor Rotation Check		
Option:		Function:
		Following installation and connection of the motor, this function allows the correct motor rotation direction to be verified. Enabling this function overrides any bus commands or digital

1-28 Motor Rotation Check		
Option:		Function:
		inputs, except External Interlock and Safe Stop (if included).
[0] *	Off	Motor Rotation Check is not active.
[1]	Enabled	Motor Rotation Check is enabled.

NOTE

Once the motor rotation check is enabled the display shows: "Note! Motor may run in wrong direction". Pressing [OK], [Back] or [Cancel] will dismiss the message and display a new message: "Press [Hand On] to start the motor. Press [Cancel] to abort". Pressing [Hand On] starts the motor at 5 Hz in forward direction and the display shows: "Motor is running. Check if motor rotation direction is correct. Press [Off] to stop the motor". Pressing [Off] stops the motor and resets *1-28 Motor Rotation Check*. If motor rotation direction is incorrect, two motor phase cables should be interchanged.

WARNING

Mains power must be removed before disconnecting motor phase cables.

1-29 Automatic Motor Adaptation (AMA)		
Option:		Function:
		The AMA function optimizes dynamic motor performance by automatically optimizing the advanced motor <i>1-30 Stator Resistance (Rs)</i> to <i>1-35 Main Reactance (Xh)</i> while the motor is stationary.
[0] *	Off	No function
[1]	Enable Complete AMA	Performs AMA of the stator resistance R_s , the rotor resistance R_r , the stator leakage reactance X_1 , the rotor leakage reactance X_2 and the main reactance X_h .
[2]	Enable Reduced AMA	Performs a reduced AMA of the stator resistance R_s in the system only. Select this option if an LC filter is used between the frequency converter and the motor.

NOTE

1-29 Automatic Motor Adaptation (AMA) will not have effect when *1-10 Motor Construction* = *[1] PM, non salient SPM*.

Activate the AMA function by pressing [Hand on] after selecting [1] or [2]. See also the item *Automatic Motor Adaptation* in the Design Guide. After a normal sequence, the display will read: "Press [OK] to finish AMA". After pressing the [OK] key the frequency converter is ready for operation.

NOTE

- For the best adaptation of the frequency converter, run AMA on a cold motor
- AMA cannot be performed while the motor is running

NOTE

Avoid generating external torque during AMA.

NOTE

If one of the settings in parameter group 1-2* Motor Data is changed, 1-30 Stator Resistance (Rs) to 1-39 Motor Poles, the advanced motor parameters, will return to default setting.

This parameter cannot be adjusted while the motor is running.

NOTE

Full AMA should be run without filter only while reduced AMA should be run with filter.

See section: Application Examples > Automatic Motor Adaptation in the Design Guide.

3.3.5 1-3* Adv. Motor Data

Parameters for advanced motor data. The motor data in 1-30 Stator Resistance (Rs) to 1-39 Motor Poles must match the relevant motor in order to run the motor optimally. The default settings are figures based on common motor parameter values from normal standard motors. If the motor parameters are not set correctly, a malfunction of the frequency converter system may occur. If the motor data is not known, running an AMA (Automatic Motor Adaptation) is recommended. See the Automatic Motor Adaptation section. The AMA sequence will adjust all motor parameters except the moment of inertia of the rotor and the iron loss resistance (1-36 Iron Loss Resistance (Rfe)).

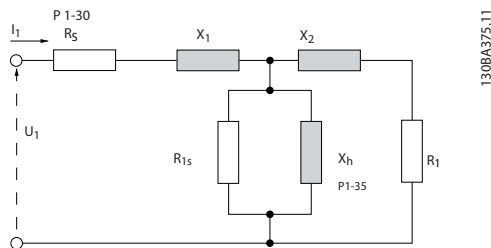
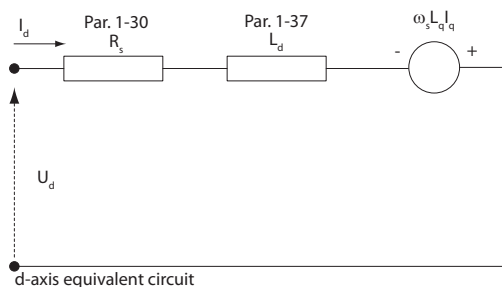
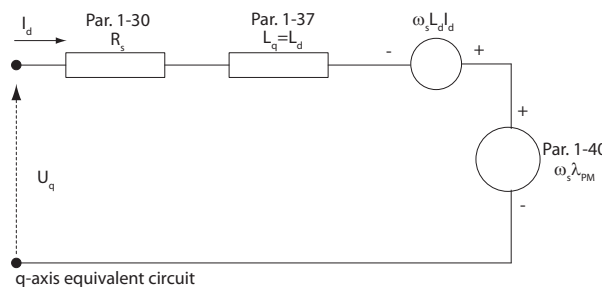

Illustration 3.4 Motor Equivalent Diagram for an Asynchronous Motor



d-axis equivalent circuit



q-axis equivalent circuit

Illustration 3.5 Motor Equivalent Circuit Diagram for a PM Non Salient Motor

1-30 Stator Resistance (Rs)		
Range:	Function:	
Size related*	[0.0140 - 140.0000 Ohm]	Set the stator resistance value. Enter the value from a motor data sheet or perform an AMA on a cold motor. This parameter cannot be adjusted while the motor is running.

1-31 Rotor Resistance (Rr)		
Range:	Function:	
Size related*	[0.0100 - 100.0000 Ohm]	Fine-tuning R _r will improve shaft performance. Set the rotor resistance value using one of these methods: <ol style="list-style-type: none"> 1. Run an AMA on a cold motor. The frequency converter will measure the value from the motor. All compensations are reset to 100%. 2. Enter the R_r value manually. Obtain the value from the motor supplier. 3. Use the R_r default setting. The frequency converter establishes the setting on the basis of the motor nameplate data.

NOTE

1-31 Rotor Resistance (Rr) will not have effect when 1-10 Motor Construction = [1] PM, non salient SPM.

1-35 Main Reactance (Xh)		
Range:		Function:
Size related*	[1.0000 - 10000.0000 Ohm]	Set the main reactance of the motor using one of these methods: <ol style="list-style-type: none"> 1. Run an AMA on a cold motor. The frequency converter will measure the value from the motor. 2. Enter the X_h value manually. Obtain the value from the motor supplier. 3. Use the X_h default setting. The frequency converter establishes the setting on the basis of the motor name plate data.

NOTE

1-35 Main Reactance (Xh) will not have effect when 1-10 Motor Construction = [1] PM, non salient SPM.

NOTE

This parameter cannot be adjusted while running.

1-36 Iron Loss Resistance (Rfe)		
Range:		Function:
Size related*	[0 - 10000.000 Ohm]	Enter the equivalent iron loss resistance (R_{Fe}) value to compensate for iron losses in the motor. The R_{Fe} value cannot be found by performing an AMA. The R_{Fe} value is especially important in torque control applications. If R_{Fe} is unknown, leave 1-36 Iron Loss Resistance (Rfe) on default setting.

NOTE

This parameter cannot be adjusted while the motor is running.

NOTE

This parameter is not available from the LCP.

1-37 d-axis Inductance (Ld)		
Range:		Function:
Size related*	[0.000 - 0.000 mH]	Enter the value of the d-axis inductance. Obtain the value from the permanent magnet motor data sheet.

NOTE

This parameter is only active when 1-10 Motor Construction has the value PM, non-salient SPM [1] (Permanent Magnet Motor).

Stator resistance and d-axis Inductance values are normally, for asynchronous motors, described in technical specifications as between line and common (starpoint). For Permanent magnet motors they are typically described in technical specifications as between Line-Line. PM motors are typically built for star connection.

1-30 Stator Resistance (Rs) (Line to common)	This parameter gives stator winding resistance (R_s) Similar to Asynchronous Motor Stator resistance. The Stator resistance is defined for line to common measurement. That means for line-line data (Where stator resistance is measured between any two lines you need to divide it with 2).
1-37 d-axis Inductance (Ld) (Line to common)	This parameter gives direct axis inductance of the PM motor. The d-axis inductance is defined for phase to common measurement. That means for line-line data (Where stator resistance is measured between any two lines you need to divide it with 2)
1-40 Back EMF at 1000 RPM RMS (Line to Line Value)	This parameter gives back emf across stator terminal of PM Motor at 1000 rpm mechanical speed specifically. It is defined between line to line and expressed in RMS Value

Table 3.4

NOTE

Motor manufacturers provide values for Stator resistance (1-30 Stator Resistance (Rs)) and d-axis Inductance (1-37 d-axis Inductance (Ld)) in technical specifications as between line and common (starpoint) or between Line-Line. There is no general standard. The different setups of Stator Winding Resistance and Induction are shown in *Illustration 3.6*. Danfoss inverters always require the line to common value. The back emf of PM motor is defined as 'Induced emf developed across any of two phases of stator winding of free running Motor'. Danfoss inverters always require the Line to Line RMS value measured at 1000 rpm, mechanical speed of rotation. This is shown in *Illustration 3.7*

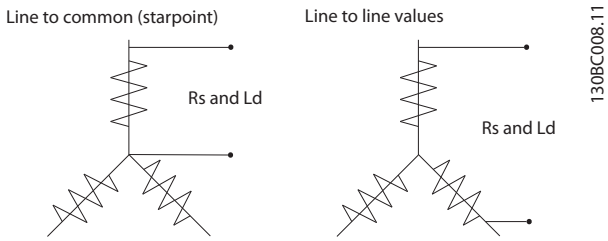

Illustration 3.6 Motor parameters are provided in different formats. Danfoss frequency converters always require the line to common value.

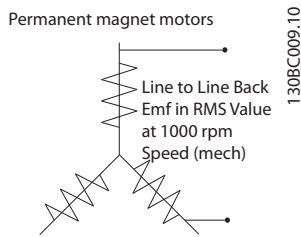

Illustration 3.7 Machine parameter definitions of Back Emf of permanent magnet motors

1-39 Motor Poles														
Range:	Function:													
Size related* [2 - 100]	Enter the number of motor poles.													
	<table border="1"> <thead> <tr> <th>Poles</th> <th>~n_n@ 50 Hz</th> <th>~n_n@60 Hz</th> </tr> </thead> <tbody> <tr> <td>2</td> <td>2700-2880</td> <td>3250-3460</td> </tr> <tr> <td>4</td> <td>1350-1450</td> <td>1625-1730</td> </tr> <tr> <td>6</td> <td>700-960</td> <td>840-1153</td> </tr> </tbody> </table>	Poles	~n _n @ 50 Hz	~n _n @60 Hz	2	2700-2880	3250-3460	4	1350-1450	1625-1730	6	700-960	840-1153	
Poles	~n _n @ 50 Hz	~n _n @60 Hz												
2	2700-2880	3250-3460												
4	1350-1450	1625-1730												
6	700-960	840-1153												
	<p>Table 3.6</p> <p>The table shows the number of poles for normal speed ranges of various motor types. Define motors designed for other frequencies setely. The motor pole value is always an even number, because it refers to the total number of poles, not pairs of poles. The frequency converter creates the initial setting of 1-39 Motor Poles based on 1-23 Motor Frequency Motor Frequency and 1-25 Motor Nominal Speed Motor Nominal Speed.</p> <p>NOTE This parameter cannot be adjusted while the motor is running.</p>													

1-40 Back EMF at 1000 RPM		
Range:	Function:	
Size related* [10 - 9000 V]	Set the nominal back EMF for the motor when running at 1000 RPM. This parameter is only active when 1-10 Motor Construction is set to PM motor [1] (Permanent Magnet Motor).	

3.3.6 1-5* Load Indep. Setting

1-50 Motor Magnetisation at Zero Speed		
Range:	Function:	
100 %* [0 - 300 %]	Use this parameter along with 1-51 Min Speed Normal Magnetising [RPM] to obtain a different thermal load on the motor when running at low speed. Enter a value which is a percentage of the rated magnetizing current. If the setting is too low, the torque on the motor shaft may be reduced.	
	<p>Illustration 3.8</p>	

NOTE

1-50 Motor Magnetisation at Zero Speed will not have effect when 1-10 Motor Construction = [1] PM, non salient SPM.

1-51 Min Speed Normal Magnetising [RPM]		
Range:	Function:	
Size related* [10 - 300 RPM]	Set the required speed for normal magnetising current. If the speed is set lower than the motor slip speed, 1-50 Motor Magnetisation at Zero Speed and 1-51 Min Speed Normal Magnetising [RPM] are of no significance. Use this parameter along with 1-50 Motor Magnetisation at Zero Speed. See Table 3.6.	

NOTE

1-51 Min Speed Normal Magnetising [RPM] will not have effect when 1-10 Motor Construction = [1] PM, non salient SPM.

1-52 Min Speed Normal Magnetising [Hz]		
Range:	Function:	
Size related*	[0.3 - 10.0 Hz]	Set the required frequency for normal magnetising current. If the frequency is set lower than the motor slip frequency, <i>1-50 Motor Magnetisation at Zero Speed</i> and <i>1-51 Min Speed Normal Magnetising [RPM]</i> are inactive. Use this parameter along with <i>1-50 Motor Magnetisation at Zero Speed</i> . See Table 3.6.

NOTE

1-52 Min Speed Normal Magnetising [Hz] will not have effect when *1-10 Motor Construction* = [1] PM, non salient SPM.

1-58 Flystart Test Pulses Current		
Range:	Function:	
Size related*	[0 - 0 %]	Set the magnitude of the magnetizing current for the pulses used to detect the motor direction. The value range and function depends on parameter <i>1-10 Motor Construction</i> : [0] Asynchron: [0-200%] Reducing this value will reduce the generated torque. 100% means full nominal motor current. In this case the default value is 30%. [1] PM non salient: [0-40%] A general setting of 20% is recommended on PM motors. Higher values can give increased performance. However, on motors with back EMF higher than 300VLL (rms) at nominal speed and high winding inductance (more than 10mH) a lower value is recommended to avoid wrong speed estimation. The parameter is active when <i>1-73 Flying Start</i> is enabled.

NOTE

See description of *1-70 PM Start Mode* for an overview of the relation between the PM Flying Start parameters.

1-59 Flystart Test Pulses Frequency		
Range:	Function:	
Size related*	[0 - 0 %]	The parameter is active when <i>1-73 Flying Start</i> is enabled. The value range and function depends on parameter <i>1-10 Motor Construction</i> : [0] Asynchron: [0-500%] Control the percentage of the frequency for the pulses used to detect the motor direction. Increasing this value will reduce the generated torque. In this mode 100% means 2 times the slip frequency. [1] PM non salient: [0-10%] This parameter defines the motor speed (in % of nominal motor speed) below which the Parking function (see <i>2-06 Parking Current</i> and

1-59 Flystart Test Pulses Frequency		
Range:	Function:	
		<i>2-07 Parking Time</i> will become active. This parameter is only active when <i>1-70 PM Start Mode</i> is set to [1] Parking and only after starting the motor.

NOTE

Do NOT set this parameter too high in high inertia applications.

3.3.7 1-6* Load Depend. Setting

1-60 Low Speed Load Compensation										
Range:	Function:									
100 %*	[0 - 300 %]	Enter the % value to compensate voltage in relation to load when the motor is running at low speed and obtain the optimum U/f characteristic. The motor size determines the frequency range within which this parameter is active.								
<table border="1"> <thead> <tr> <th>Motor size [kW]</th> <th>Change over [Hz]</th> </tr> </thead> <tbody> <tr> <td>0.25 -7.5</td> <td>< 10</td> </tr> <tr> <td>11-45</td> <td>< 5</td> </tr> <tr> <td>55 -550</td> <td>< 3-4</td> </tr> </tbody> </table>			Motor size [kW]	Change over [Hz]	0.25 -7.5	< 10	11-45	< 5	55 -550	< 3-4
Motor size [kW]	Change over [Hz]									
0.25 -7.5	< 10									
11-45	< 5									
55 -550	< 3-4									
Table 3.7										

NOTE

1-60 Low Speed Load Compensation will not have effect when *1-10 Motor Construction* = [1] PM, non salient SPM.

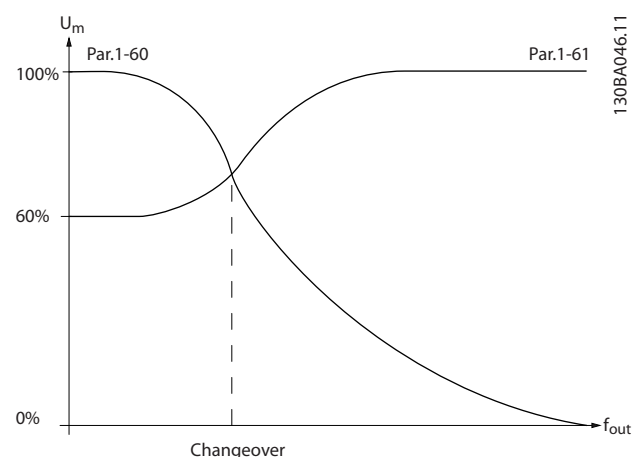

Illustration 3.9

1-61 High Speed Load Compensation		
Range:	Function:	
100 %* [0 - 300 %]	Enter the % value to compensate voltage in relation to load when the motor is running at high speed and obtain the optimum U/f characteristic. The motor size determines the frequency range within which this parameter is active.	
	Motor size [kW]	Change-over [Hz]
	0.25-7.5	> 10
	11-45	< 5
	55-550	< 3-4
	Table 3.8	

NOTE

1-61 High Speed Load Compensation will not have effect when 1-10 Motor Construction = [1] PM, non salient SPM.

1-62 Slip Compensation		
Range:	Function:	
0 %* [-500 - 500 %]	Enter the % value for slip compensation, to compensate for tolerances in the value of $n_{M,N}$. Slip compensation is calculated automatically, i.e. on the basis of the rated motor speed $n_{M,N}$.	

NOTE

1-62 Slip Compensation will not have effect when 1-10 Motor Construction = [1] PM, non salient SPM.

1-63 Slip Compensation Time Constant		
Range:	Function:	
Size related* [0.05 - 5 s]	Enter the slip compensation reaction speed. A high value results in slow reaction, and a low value results in quick reaction. If low-frequency resonance problems arise, use a longer time setting.	

NOTE

1-63 Slip Compensation Time Constant will not have effect when 1-10 Motor Construction = [1] PM, non salient SPM.

1-64 Resonance Dampening		
Range:	Function:	
100 %* [0 - 500 %]	Enter the resonance dampening value. Set 1-64 Resonance Dampening and 1-65 Resonance Dampening Time Constant to help eliminate high-frequency resonance problems. To reduce resonance oscillation, increase the value of 1-64 Resonance Dampening.	

NOTE

1-64 Resonance Dampening will not have effect when 1-10 Motor Construction = [1] PM, non salient SPM.

1-65 Resonance Dampening Time Constant		
Range:	Function:	
5 ms* [5 - 50 ms]	Set 1-64 Resonance Dampening and 1-65 Resonance Dampening Time Constant to help eliminate high-frequency resonance problems. Enter the time constant that provides the best dampening.	

NOTE

1-65 Resonance Dampening Time Constant will not have effect when 1-10 Motor Construction = [1] PM, non salient SPM.

1-66 Min. Current at Low Speed		
Range:	Function:	
Size related* [1 - 200 %]	Enter the minimum motor current at low speed. Increasing this current improves developed motor torque at low speed. Low speed is here defined as speeds below 6% of the Nominal Speed of Motor (1-25 Motor Nominal Speed) in VVC ^{plus} PM Control	

NOTE

1-66 will not have affect if 1-10 =[0]

3.3.8 1-7* Start Adjustments

1-70 PM Start Mode		
Option:	Function:	
[0] Rotor Detection	Suitable for all applications where the motor is known to be standing still when starting (e.g. conveyors, pumps and non wind milling fans).	
[1] Parking	If the motor turns at a slight speed (i.e. lower than 2-5% of the nominal speed) e.g. due to fans with light wind milling, select [1] Parking and adjust 2-06 Parking Current and 2-07 Parking Time accordingly.	

1-71 Start Delay		
Range:	Function:	
0 s* [0.0 - 120.0 s]	This parameter refers to the start function selected in 1-72 Start Function. Enter the time delay required before commencing acceleration. The parameter is also used for delayed start of compressor functionality in Injection Control.	

1-71 Start Delay	
Range:	Function:
	28-91 <i>Delayed Compressor Start</i> controls the delayed start feature. If 28-91 <i>Delayed Compressor Start</i> is set then delayed start is activated. If 28-91 <i>Delayed Compressor Start</i> is reset then delayed start is deactivated. It is recommended that the start delay value should be set equal to or greater than default value.

1-72 Start Function	
Option:	Function:
	Select the start function during start delay. This parameter is linked to 1-71 <i>Start Delay</i> .
[0]	DC Hold/ Motor Preheat Energizes motor with a DC holding current (2-00 <i>DC Hold/Preheat Current</i>) during the start delay time.
[1]	DC Brake Energizes motor with a DC braking current (2-01 <i>DC Brake Current</i>) during the start delay time.
[2] *	Coast Releases shaft coasted converter during the start delay time (inverter off). Available selections depend on 1-10 <i>Motor Construction</i> : [0] <i>Asynchron</i> : [2] coast [0] DC-hold [1] <i>PM non salient</i> : [2] coast
[3]	Start speed cw Only possible with VVC ^{plus} . Connect the function described in 1-74 <i>Start Speed [RPM]</i> and 1-76 <i>Start Current</i> in the start delay time. Regardless of the value applied by the reference signal, the output speed applies the setting of the start speed in 1-74 <i>Start Speed [RPM]</i> or 1-75 <i>Start Speed [Hz]</i> and the output current corresponds to the setting of the start current in 1-76 <i>Start Current</i> . This function is typically used in hoisting applications without counterweight and especially in applications with a Cone-motor, where the start is clockwise, followed by rotation in the reference direction.
[5]	VVC+/Flux clockwise For the function described in 1-74 <i>Start Speed [RPM]</i> (<i>Start speed in the start delay time</i>). The start current is calculated automatically. This function uses the start speed in the start delay time only. Regardless of the value set by the reference signal, the output speed equals the setting of the start speed in 1-74 <i>Start Speed [RPM]</i> . [3] <i>Start speed/current clockwise</i> and [5] <i>VVC^{plus}/Flux clockwise</i> are typically used in

1-72 Start Function	
Option:	Function:
	hoisting applications. [4] <i>Start speed/current in reference direction</i> is icularly used in applications with counterweight and horizontal movement.

1-73 Flying Start	
Option:	Function:
	This function makes it possible to catch a motor which is spinning freely due to a mains drop-out. When 1-73 <i>Flying Start</i> is enabled, 1-71 <i>Start Delay</i> has no function. Search direction for flying start is linked to the setting in 4-10 <i>Motor Speed Direction</i> . [0] <i>Clockwise</i> : Flying start search in clockwise direction. If not successful, a DC brake is carried out. [2] <i>Both Directions</i> : The flying start will first make a search in the direction determined by the last reference (direction). If not finding the speed it will make a search in the other direction. If not successful, a DC brake will be activated in the time set in 2-02 <i>DC Braking Time</i> . Start will then take place from 0 Hz.
[0] *	Disabled Select [0] <i>Disable</i> if this function is not required
[1]	Enabled Select [1] <i>Enable</i> to enable the frequency converter to "catch" and control a spinning motor. The parameter is always set to [1] <i>Enable</i> when 1-10 <i>Motor Construction</i> = [1] <i>PM non salient</i> . Important related parameters: <ul style="list-style-type: none"> 1-58 <i>Flystart Test Pulses Current</i> 1-59 <i>Flystart Test Pulses Frequency</i> 1-70 <i>PM Start Mode</i> 2-06 <i>Parking Current</i> 2-07 <i>Parking Time</i> 2-03 <i>DC Brake Cut In Speed [RPM]</i> 2-04 <i>DC Brake Cut In Speed [Hz]</i> 2-06 <i>Parking Current</i> 2-07 <i>Parking Time</i>

The Flystart function used for PM motors is based on an initial speed estimation. The speed will always be estimated as the first thing after an active start signal is given. Based on the setting of 1-70 *PM Start Mode* the following will happen:
1-70 *PM Start Mode* = [0] *Rotor Detection*:
If the speed estimate comes out as greater than 0 Hz the frequency converter will catch the motor at that speed and resume normal operation. Otherwise, the frequency

converter will estimate the rotor position and start normal operation from there.

1-70 PM Start Mode = [1] Parking:

If the speed estimate comes out lower than the setting in *1-59 Flystart Test Pulses Frequency* then the Parking function will be engaged (see *2-06 Parking Current* and *2-07 Parking Time*). Otherwise the frequency converter will catch the motor at that speed and resume normal operation. Refer to description of *1-70 PM Start Mode* for recommended settings.

Current limitations of the Flystart Principle used for PM motors:

- The speed range is up to 100% Nominal Speed or the field weakening speed (which ever is lowest).
- PMSM with high back emf (>300 VLL(rms)) and high winding inductance(>10 mH) needed more time for reducing short circuit current to zero and may be susceptible to error in estimation.
- Current testing limited to a speed range up to 300 Hz. For certain units the limit is 250 Hz; all 200-240 V units up to and including 2.2 kW and all 380-480 V units up to and including 4 kW.
- Current testing limited to a machine power size up to 22 kW.
- Pred for salient pole machine (IPMSM) but not yet verified on those types of machine.
- For high inertia applications (i.e. where the load inertia is more than 30 times larger than the motor inertia) a brake resistor is recommended to avoid over-voltage trip during high speed engagement of the fly-start function.

1-77 Compressor Start Max Speed [RPM]	
Range:	Function:
Size related* [0 - 4-13 RPM]	The parameter enables "High Starting Torque". This is a function, where the Current Limit and Torque Limit are ignored during start of the motor. The time, from the start signal is given until the speed exceeds the speed set in this parameter, becomes a "start-zone" where the current limit and motoric torque limit is set to what is maximum possible for the frequency converter/motor combination. This parameter is normally set to the same value as <i>4-11 Motor Speed Low Limit [RPM]</i> . When set to zero the function is inactive. In this "starting-zone" <i>3-82 Starting Ramp Up Time</i> is active instead of <i>3-40 Ramp 1 Type</i> to ensure extra acceleration during the start and to minimize the time where the motor is operated under the minimum speed for the application. The time without protection

1-77 Compressor Start Max Speed [RPM]	
Range:	Function:
	from the Current Limit and Torque Limit must not exceed the value set in <i>1-79 Compressor Start Max Time to Trip</i> or the frequency converter will trip with an alarm [A18] Start Failed. When this function is activated to get a fast start then also <i>1-86 Compressor Min. Speed for Trip [RPM]</i> is activated to protect the application from running below minimum motor speed e.g. when in current limit. This function allows high starting torque and use of a fast starting ramp. To ensure the build-up of a high torque during the start, various tricks can be done through clever use of start delay/start speed/start current.

NOTE

1-77 Compressor Start Max Speed [RPM] will not have effect when *1-10 Motor Construction = [1] PM, non salient SPM.*

1-78 Compressor Start Max Speed [Hz]	
Range:	Function:
Size related* [0 - 4-14 Hz]	The parameter enables "High Starting Torque". This is a function, where the Current Limit and Torque Limit are ignored during start of the motor. The time, from the start signal is given until the speed exceeds the speed set in this parameter, becomes a "start-zone" where the current limit and motoric torque limit is set to what is maximum possible for the frequency converter/motor combination. This parameter is normally set to the same value as <i>4-11 Motor Speed Low Limit [RPM]</i> . When set to zero the function is inactive. In this "starting-zone" <i>3-82 Starting Ramp Up Time</i> is active instead of <i>3-41 Ramp 1 Ramp Up Time</i> to ensure extra acceleration during the start and to minimize the time where the motor is operated under the minimum speed for the application. The time without protection from the Current Limit and Torque Limit must not exceed the value set in <i>1-79 Compressor Start Max Time to Trip</i> or the frequency converter will trip with an alarm [A18] Start Failed. When this function is activated to get a fast start then also <i>1-86 Compressor Min. Speed for Trip [RPM]</i> is activated to protect the application from running below minimum motor speed e.g. when in current limit. This function allows high starting torque and use of a fast starting ramp. To ensure the build-up of a high torque during the start,

1-78 Compressor Start Max Speed [Hz]		
Range:	Function:	
	various tricks can be done through clever use of start delay/start speed/start current.	

NOTE

1-78 Compressor Start Max Speed [Hz] will not have effect when 1-10 Motor Construction = [1] PM, non salient SPM.

1-79 Compressor Start Max Time to Trip		
Range:	Function:	
5 s* [0 - 10 s]	The time, from the start signal is given until the speed exceeds the speed set in 1-77 Compressor Start Max Speed [RPM] must not exceed the time set in the parameter or the frequency converter will trip with an alarm [A18] Start Failed. Any time set in 1-71 Start Delay for use of a start function must be executed within the time limit.	

NOTE

1-79 Compressor Start Max Time to Trip will not have effect when 1-10 Motor Construction = [1] PM, non salient SPM.

3.3.9 1-8* Stop Adjustments

1-80 Function at Stop		
Option:	Function:	
	Select the frequency converter function after a stop command or after the speed is ramped down to the settings in 1-81 Min Speed for Function at Stop [RPM]. Available selections depend on 1-10 Motor Construction: [0] Asynchron: [0] coast [1] DC-hold [2] Motor check, warning [6] Motor check, alarm [1] PM non salient: [0] coast	
[0] *	Coast	Leaves motor in free mode.

1-81 Min Speed for Function at Stop [RPM]		
Range:	Function:	
Size related*	[0 - 600 RPM]	Set the speed at which to activate 1-80 Function at Stop.

1-82 Min Speed for Function at Stop [Hz]		
Range:	Function:	
Size related*	[0 - 20.0 Hz]	Set the output frequency at which to activate 1-80 Function at Stop.

1-86 Compressor Min. Speed for Trip [rpm]		
Range:	Function:	
0 rpm* [0.0 - 1-77 minus 100 rpm]	When "High Starting Torque" is activated by setting of 1-77 Compressor Start Max Speed [RPM] then a protection functionality is also enabled to prevent the application from running below minimum motor speed e.g. when in current limit. If the speed at any time after the start (or during a stop) falls below the value in the parameter, the frequency converter will trip with an alarm [A49] Speed Limit. <i>Function at stop.</i>	

1-87 Compressor Min. Speed for Trip [Hz]		
Range:	Function:	
0 Hz* [0.0 - 1-78 minus ??? Hz]	When "High Starting Torque" is activated by setting of 1-77 Compressor Start Max Speed [RPM] then a protection functionality is also enabled to prevent the application from running below minimum motor speed e.g. when in current limit. If the speed at any time after the start (or during a stop) falls below the value in the parameter, the frequency converter will trip with an alarm [A49] Speed Limit. <i>Function at stop.</i>	

3.3.10 1-9* Motor Temperature

1-90 Motor Thermal Protection		
Option:	Function:	
	The frequency converter determines the motor temperature for motor protection in two different ways: <ul style="list-style-type: none"> Via a thermistor sensor connected to one of the analog or digital inputs (1-93 Thermistor Source). Via calculation (ETR = Electronic Thermal Relay) of the thermal load, based on the actual load and time. The calculated thermal load is comed with the rated motor current $I_{M,N}$ and the rated motor frequency $f_{M,N}$. The calculations estimate the need for a lower load at lower speed due to less cooling from the fan incorporated in the motor. 	
[0]	No protection	If the motor is continuously overloaded and no warning or trip of frequency converter is wanted.

ETR (Electronic Thermal Relay) functions 1-4 will calculate the load when set-up where they were selected is active.

For example ETR-3 starts calculating when set-up 3 is selected. For the North American market: The ETR functions provide class 20 motor overload protection in accordance with NEC.

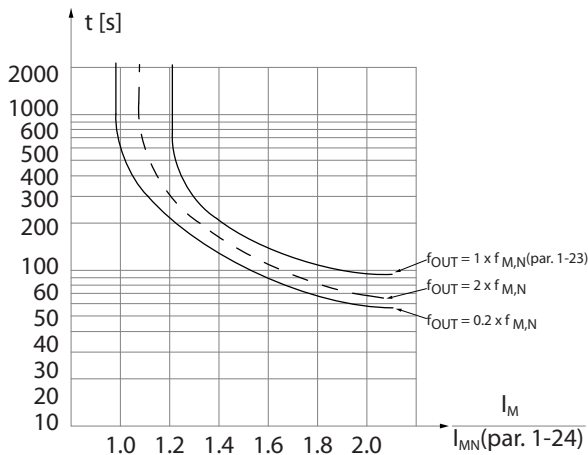

Illustration 3.10

⚠ WARNING

In order to maintain PELV, all connections made to the control terminals must be PELV, e.g. thermistor must be reinforced/double insulated

NOTE

Danfoss recommends using 24 V DC as thermistor supply voltage.

NOTE

The ETR timer function does not work when 1-10 Motor Construction = [1] PM, non salient SPM.

NOTE

For correct operation of ETR function setting in 1-03 Torque Characteristics must fit the application (see description of 1-03 Torque Characteristics).

1-91 Motor External Fan	
Option:	Function:
[0] *	None No external fan is required, i.e. the motor is derated at low speed.

1-93 Thermistor Source	
Option:	Function:
[0] *	None Select the input to which the thermistor (PTC sensor) should be connected. An analog input option [1] or [2] cannot be selected if the analog input is already in use as a reference source (selected in 3-15 Reference 1 Source, 3-16 Reference 2 Source or 3-17 Reference 3 Source). When using MCB 112, choice [0] None must always be selected.
[1]	Analog Input 53
[2]	Analog Input 54
[3]	Digital input 18
[4]	Digital input 19
[5]	Digital input 32
[6]	Digital input 33

NOTE

This parameter cannot be adjusted while the motor is running.

NOTE

Digital input should be set to [0] PNP - Active at 24 V in 5-00 Digital I/O Mode.

3

3.4 Main Menu - Brakes - Group 2

3.4.1 2-0* DC-Brakes

Parameter group for configuring the DC brake and DC hold functions.

2-00 DC Hold/Preheat Current		
Range:	Function:	
50 %* [0 - 160 %]	Enter a value for holding current as a percentage of the rated motor current $I_{M,N}$ set in 1-24 Motor Current. 100% DC holding current corresponds to $I_{M,N}$. This parameter holds the motor (holding torque) or pre-heats the motor. This parameter is active if [1] DC hold/Motor Preheat is selected in 1-80 Function at Stop.	

NOTE

2-00 DC Hold/Preheat Current will not have effect when 1-10 Motor Construction = [1] PM, non salient SPM.

NOTE

The maximum value depends on the rated motor current. Avoid 100 % current for too long. It may damage the motor.

2-01 DC Brake Current		
Range:	Function:	
50 %* [0 - 1000 %]	Enter a value for current as a percentage of the rated motor current $I_{M,N}$, see 1-24 Motor Current. 100% DC braking current corresponds to $I_{M,N}$. DC brake current is applied on a stop command, when the speed is lower than the limit set in 2-03 DC Brake Cut In Speed [RPM]; when the DC Brake Inverse function is active; or via the serial communication port. The braking current is active during the time period set in 2-02 DC Braking Time.	

NOTE

The maximum value depends on the rated motor current. Avoid 100 % current for too long. It may damage the motor.

2-02 DC Braking Time		
Range:	Function:	
10 s* [0 - 60 s]	Set the duration of the DC braking current set in 2-01 DC Brake Current, once activated.	

2-03 DC Brake Cut In Speed [RPM]		
Range:	Function:	
Size related* [0 - 0 RPM]	Set the DC brake cut-in speed for activation of the DC braking current	

2-03 DC Brake Cut In Speed [RPM]		
Range:	Function:	
	set in 2-01 DC Brake Current, upon a stop command. When 1-10 Motor Construction is set to [1] PM non salient SPM this value is limited to 0 rpm (OFF)	

NOTE

2-03 DC Brake Cut In Speed [RPM] will not have effect when 1-10 Motor Construction = [1] PM, non salient SPM.

2-04 DC Brake Cut In Speed [Hz]		
Range:	Function:	
Size related*	[0 - 0.0 Hz]	

2-06 Parking Current		
Range:	Function:	
50 %* [0 - 1000 %]	Set current as percentage of rated motor current, 1-24 Motor Current. Active in connection with 1-73 Flying Start. The ing current is active during the time period set in 2-07 Parking Time.	

NOTE

2-06 Parking Current and 2-07 Parking Time: Only active if PM motor construction is selected in 1-10 Motor Construction.

2-07 Parking Time		
Range:	Function:	
3 s* [0.1 - 60 s]	Set the duration of the ing current time set in 2-06 Parking Current. Active in connection with 1-73 Flying Start.	

3.4.2 2-1* Brake Energy Funct.

Parameter group for selecting dynamic braking parameters. Only valid for frequency converters with brake chopper.

2-10 Brake Function		
Option:	Function:	
	Available selections depend on 1-10 Motor Construction: [0] Asynchron: [0] off [1] Resistor brake [2] AS brake [1] PM non salient: [0] off [1] Resistor brake	
[0] *	Off	No brake resistor installed.

2-16 AC brake Max. Current		
Range:	Function:	
100 %* [0 - 1000.0 %]	Enter the maximum permissible current when using AC brake to avoid overheating of motor windings. The AC brake function is available in Flux mode only.	

NOTE

2-16 AC brake Max. Current will not have effect when 1-10 Motor Construction = [1] PM, non salient SPM.

2-17 Over-voltage Control		
Option:	Function:	
[0]	Disabled	No OVC required.
[2] *	Enabled	Activates OVC.

NOTE

2-17 Over-voltage Control will not have effect when 1-10 Motor Construction = [1] PM, non salient SPM.

NOTE

The ramp time is automatically adjusted to avoid tripping of the frequency converter.

3.5 Main Menu - Reference/Ramps - Group 3

3.5.1 3-0* Reference Limits

3-02 Minimum Reference		
Range:	Function:	
Size related* [-999999.999 - par. 3-03 ReferenceFeed-backUnit]	Enter the Minimum Reference. The Minimum Reference is the lowest value obtainable by summing all references. The Minimum Reference value and unit matches the configuration choice made in <i>1-00 Configuration Mode</i> and <i>20-12 Reference/Feedback Unit</i> , respectively.	
<p>NOTE This parameter is used in open loop only.</p>		

3-04 Reference Function		
Option:	Function:	
[0] * Sum	Sums both external and preset reference sources.	
[1] External/Preset	Use either the preset or the external reference source. Shift between external and preset via a command on a digital input.	

3-04 Reference Function		
Option:	Function:	
[0] * Sum	Sums both external and preset reference sources.	
[1] External/Preset	Use either the preset or the external reference source. Shift between external and preset via a command or a digital input.	

3.5.2 3-1* References

Select the preset reference(s). Select Preset ref. bit 0/1/2 [16], [17] or [18] for the corresponding digital inputs in parameter group 5-1*.

3-10 Preset Reference		
Array [8]		
Range:	Function:	
0 %* [-100 - 100 %]	Enter up to eight different preset references (0-7) in this parameter, using array programming. The preset reference is stated as a percentage of the value Ref _{MAX} (3-03 Maximum Reference, for closed loop see 20-14 Maximum Reference/Feedb.). When using	

3-10 Preset Reference		
Array [8]		
Range:	Function:	
	preset references, select Preset ref. bit 0/1/2 [16], [17] or [18] for the corresponding digital inputs in parameter group 5-1* Digital Inputs.	

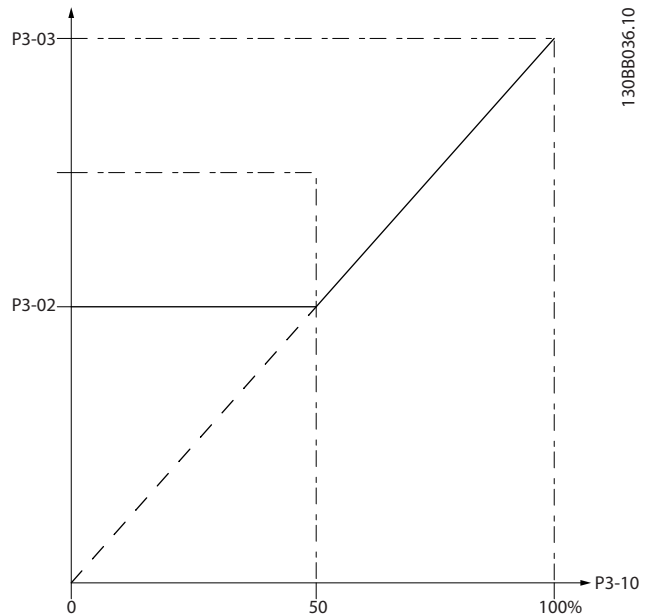

Illustration 3.11

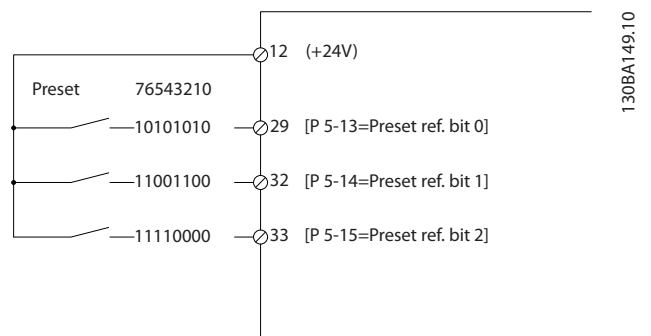

Illustration 3.12

3-11 Jog Speed [Hz]		
Range:	Function:	
Size related* [0 - par. 4-14 Hz]	The jog speed is a fixed output speed at which the frequency converter is running when the jog function is activated. See also 3-80 Jog Ramp Time.	

3-13 Reference Site		
Option:	Function:	
		Select which reference site to activate.
[0] *	Linked to Hand / Auto	Use local reference when in Hand mode; or remote reference when in Auto mode.
[1]	Remote	Use remote reference in both Hand mode and Auto mode.
[2]	Local	Use local reference in both Hand mode and Auto mode.

NOTE
When set to [2] Local, the frequency converter will start with this setting again following a 'power down'.

3-14 Preset Relative Reference		
Range:	Function:	
0 %* [-100 - 100 %]	The actual reference, X, is increased or decreased with the percentage Y, set in 3-14 Preset Relative Reference. This results in the actual reference Z. Actual reference (X) is the sum of the inputs selected in 3-15 Reference 1 Source, 3-16 Reference 2 Source, 3-17 Reference 3 Source and 8-02 Control Source.	

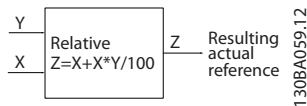

Illustration 3.13

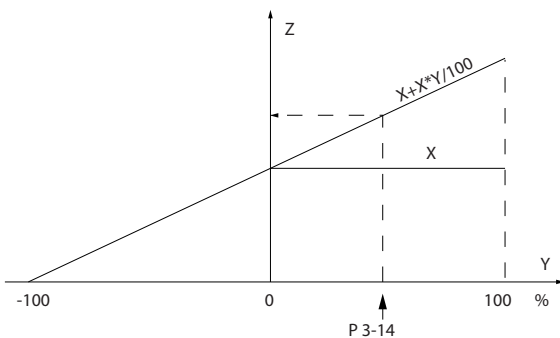

Illustration 3.14

3-15 Reference 1 Source		
Option:	Function:	
	Select the reference input to be used for the first reference signal. 3-15 Reference 1 Source, 3-16 Reference 2 Source and 3-17 Reference 3 Source define up to three different reference signals. The sum of these reference signals defines the actual reference.	

3-15 Reference 1 Source		
Option:	Function:	
[0]	No function	
[1] *	Analog Input 53	
[2]	Analog Input 54	
[7]	Pulse input 29	
[8]	Pulse input 33	
[20]	Digital pot.meter	
[21]	Analog input X30/11	
[22]	Analog input X30/12	
[23]	Analog Input X42/1	
[24]	Analog Input X42/3	
[25]	Analog Input X42/5	
[30]	Ext. Closed Loop 1	
[31]	Ext. Closed Loop 2	
[32]	Ext. Closed Loop 3	

NOTE

This parameter cannot be changed while the motor is running.

3-16 Reference 2 Source		
Option:	Function:	
	Select the reference input to be used for the second reference signal. 3-15 Reference 1 Source, 3-16 Reference 2 Source and 3-17 Reference 3 Source define up to three different reference signals. The sum of these reference signals defines the actual reference.	
[0]	No function	
[1]	Analog Input 53	
[2]	Analog Input 54	
[7]	Pulse input 29	
[8]	Pulse input 33	
[20] *	Digital pot.meter	
[21]	Analog input X30/11	
[22]	Analog input X30/12	
[23]	Analog Input X42/1	
[24]	Analog Input X42/3	
[25]	Analog Input X42/5	
[30]	Ext. Closed Loop 1	
[31]	Ext. Closed Loop 2	
[32]	Ext. Closed Loop 3	

NOTE

This parameter cannot be changed while the motor is running.

3-17 Reference 3 Source		
Option:	Function:	
		Select the reference input to be used for the third reference signal. 3-15 Reference 1 Source, 3-16 Reference 2 Source and 3-17 Reference 3 Source define up to three different reference signals. The sum of these reference signals defines the actual reference.
[0] *	No function	
[1]	Analog Input 53	
[2]	Analog Input 54	
[7]	Pulse input 29	
[8]	Pulse input 33	
[20]	Digital pot.meter	
[21]	Analog input X30/11	
[22]	Analog input X30/12	
[23]	Analog Input X42/1	
[24]	Analog Input X42/3	
[25]	Analog Input X42/5	
[30]	Ext. Closed Loop 1	
[31]	Ext. Closed Loop 2	
[32]	Ext. Closed Loop 3	

NOTE

This parameter cannot be changed while the motor is running.

3-19 Jog Speed [RPM]		
Range:	Function:	
Size related*	[0 - par. 4-13 RPM]	Enter a value for the jog speed n_{JOG} , which is a fixed output speed. The frequency converter runs at this speed when the jog function is activated. The maximum limit is defined in 4-13 Motor Speed High Limit [RPM]. See also 3-80 Jog Ramp Time.

3.5.3 3-4* Ramp 1

Configure the ramp parameter, ramping times, for each of the two ramps (parameter group 3-4* and parameter group 3-5*).

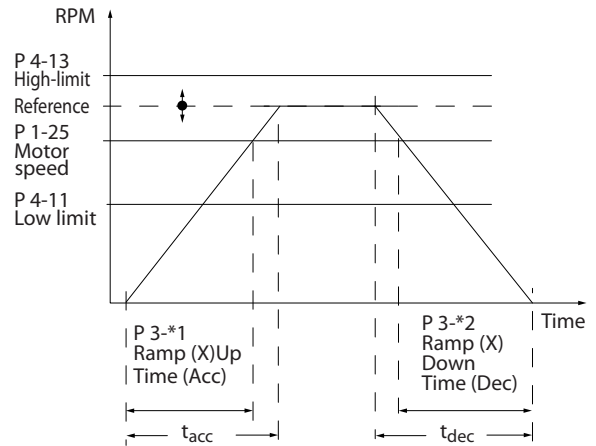

Illustration 3.15

3-41 Ramp 1 Ramp Up Time		
Range:	Function:	
Size related*	[1.00 - 3600 s]	Enter the ramp-up time, i.e. the acceleration time from 0 RPM to 1-25 Motor Nominal Speed. Choose a ramp-up time such that the output current does not exceed the current limit in 4-18 Current Limit during ramping. See ramp-down time in 3-42 Ramp 1 Ramp Down Time.

$$par.3 - 41 = \frac{t_{acc} \times n_{nom} [par.1 - 25]}{ref [rpm]} [s]$$

3-42 Ramp 1 Ramp Down Time		
Range:	Function:	
Size related*	[1.00 - 3600 s]	Enter the ramp-down time, i.e. the deceleration time from 1-25 Motor Nominal Speed to 0 RPM. Choose a ramp-down time such that no over-voltage arises in the inverter due to regenerative operation of the motor, and such that the generated current does not exceed the current limit set in 4-18 Current Limit. See ramp-up time in 3-41 Ramp 1 Ramp Up Time.

$$par.3 - 42 = \frac{t_{dec} \times n_{nom} [par.1 - 25]}{ref [rpm]} [s]$$

3.5.4 3-5* Ramp 2

Choosing ramp parameters, see parameter group 3-4*.

3-51 Ramp 2 Ramp Up Time		
Range:	Function:	
Size related* [1.00 - 3600 s]	Enter the ramp-up time, i.e. the acceleration time from 0 RPM to 1-25 Motor Nominal Speed. Choose a ramp-up time such that the output current does not exceed the current limit in 4-18 Current Limit during ramping. See ramp-down time in 3-52 Ramp 2 Ramp Down Time.	
$par. 3 - 51 = \frac{t_{acc} \times n_{nom}[par. 1 - 25]}{ref[rpm]} [s]$		

3-52 Ramp 2 Ramp Down Time		
Range:	Function:	
Size related* [1.00 - 3600 s]	Enter the ramp-down time, i.e. the deceleration time from 1-25 Motor Nominal Speed to 0 RPM. Choose a ramp-down time such that no over-voltage arises in the inverter due to regenerative operation of the motor, and such that the generated current does not exceed the current limit set in 4-18 Current Limit. See ramp-up time in 3-51 Ramp 2 Ramp Up Time.	
$par. 3 - 52 = \frac{t_{dec} \times n_{nom}[par. 1 - 25]}{ref[rpm]} [s]$		

3.5.5 3-8* Other Ramps

Configure parameters for special ramps e.g. Jog.

3-80 Jog Ramp Time		
Range:	Function:	
Size related* [1 - 3600 s]	Enter the jog ramp time, i.e. the acceleration/ deceleration time between 0 RPM and the rated motor speed (n _{M,N}) (set in 1-25 Motor Nominal Speed). Ensure that the resultant output current required for the given jog ramp time does not exceed the current limit in 4-18 Current Limit. The jog ramp time starts upon activation of a jog signal via the control panel, a selected digital input, or the serial communication port.	
$par. 3 - 80 = \frac{t_{jog} \times n_{nom}[par. 1 - 25]}{jog\ speed[par. 3 - 19]} [s]$		

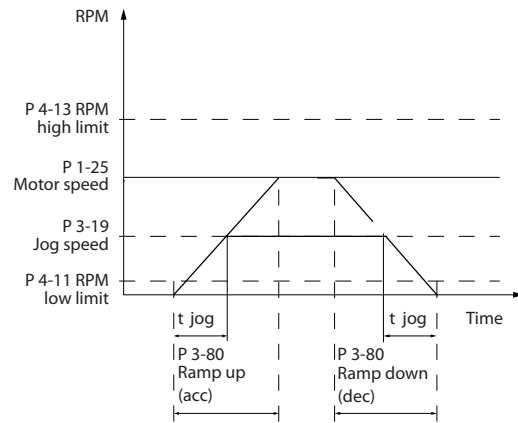

Illustration 3.16

3-81 Quick Stop Ramp Time		
Range:	Function:	
Size related* [1 - 3600 s]	Enter the quick-stop ramp-down time, i.e. the deceleration time from the synchronous motor speed to 0 RPM. Ensure that no resultant over-voltage will arise in the inverter due to regenerative operation of the motor required to achieve the given ramp-down time. Ensure also that the generated current required to achieve the given ramp-down time does not exceed the current limit (set in 4-18 Current Limit). Quick-stop is activated by means of a signal on a selected digital input, or via the serial communication port.	

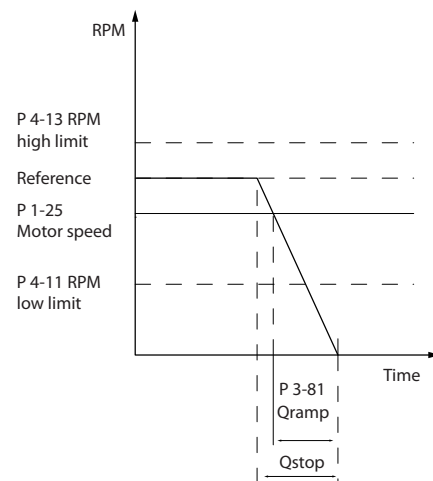

Illustration 3.17

$$Par. 3 - 81 = \frac{t_{Qstop} [s] \times n_s [RPM]}{\Delta jog\ ref(par. 3 - 19) [RPM]}$$

3-82 Starting Ramp Up Time		
Range:	Function:	
Size related* [0.01 - 3600 s]	The ramp-up time is the acceleration time from 0rpm to the nominal motor speed set in <i>3-82 Starting Ramp Up Time</i> when Compressor Torque is active in <i>1-03 Torque Characteristics</i> .	

3.5.6 3-9* Digital Pot.Meter

The digital potentiometer function allows the user to increase or decrease the actual reference by adjusting the set-up of the digital inputs using the functions INCREASE, DECREASE or CLEAR. To activate the function, at least one digital input must be set up to INCREASE or DECREASE.

3-90 Step Size		
Range:	Function:	
0.10 %* [0.01 - 200 %]	Enter the increment size required for INCREASE/DECREASE, as a percentage of the synchronous motor speed, n_s . If INCREASE/DECREASE is activated the resulting reference will be increased/decreased by the amount set in this parameter.	

3-91 Ramp Time		
Range:	Function:	
1 s [0 - 3600 s]	Enter the ramp time, i.e. the time for adjustment of the reference from 0% to 100% of the specified digital potentiometer function (INCREASE, DECREASE or CLEAR). If INCREASE/DECREASE is activated for longer than the ramp delay period specified in <i>3-95 Ramp Delay</i> the actual reference will be ramped up/down according to this ramp time. The ramp time is defined as the time used to adjust the reference by the step size specified in <i>3-90 Step Size</i> .	

3-92 Power Restore		
Option:	Function:	
[0] * Off	Resets the Digital Potentiometer reference to 0% after power up.	
[1] On	Restores the most recent Digital Potentiometer reference at power up.	

3-93 Maximum Limit		
Range:	Function:	
100 %* [-200 - 200 %]	Set the maximum permissible value for the resultant reference. This is advisable if the Digital Potentiometer is used for fine tuning of the resulting reference.	

3-94 Minimum Limit		
Range:	Function:	
0 %* [-200 - 200 %]	Set the minimum permissible value for the resultant reference. This is advisable if the Digital Potentiometer is used for fine tuning of the resulting reference.	

3-95 Ramp Delay		
Range:	Function:	
1 * [0 - 3600]	Enter the delay required from activation of the digital potentiometer function until the frequency converter starts to ramp the reference. With a delay of 0 ms, the reference starts to ramp as soon as INCREASE/DECREASE is activated. See also <i>3-91 Ramp Time</i> .	

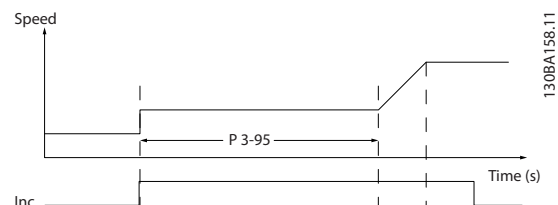

Illustration 3.18

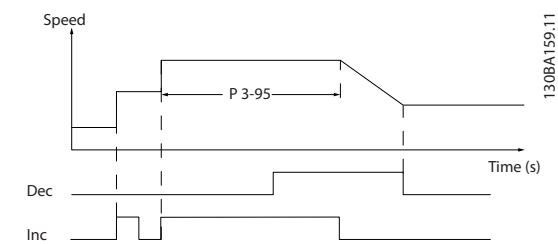

Illustration 3.19

3.6 Main Menu - Limits/Warnings - Group 4

3.6.1 4-** Limits and Warnings

Parameter group for configuring limits and warnings.

3.6.2 4-1* Motor Limits

Define torque, current and speed limits for the motor, and the reaction of the frequency converter when the limits are exceeded.

A limit may generate a message on the display. A warning will always generate a message on the display or on the fieldbus. A monitoring function may initiate a warning or a trip, upon which the frequency converter will stop and generate an alarm message.

4-10 Motor Speed Direction		
Option:	Function:	
		Selects the motor speed direction required. Use this parameter to prevent unwanted reversing.
[0]	Clockwise	Only operation in clockwise direction will be allowed.
[2] *	Both directions	Operation in both clockwise and anti-clockwise direction will be allowed.

NOTE

The setting in 4-10 Motor Speed Direction has impact on the Flying Start in 1-73 Flying Start.

4-11 Motor Speed Low Limit [RPM]		
Range:	Function:	
Size related* [0 - par. 4-13 RPM]	Enter the minimum limit for motor speed. The Motor Speed Low Limit can be set to correspond to the manufacturer's recommended minimum motor speed. The Motor Speed Low Limit must not exceed the setting in 4-13 Motor Speed High Limit [RPM].	

4-12 Motor Speed Low Limit [Hz]		
Range:	Function:	
Size related* [0 - par. 4-14 Hz]	Enter the minimum limit for motor speed. The Motor Speed Low Limit can be set to correspond to the minimum output frequency of the motor shaft. The Speed Low Limit must not exceed the setting in 4-14 Motor Speed High Limit [Hz].	

4-13 Motor Speed High Limit [RPM]		
Range:	Function:	
Size related* [par. 4-11 - 60000 RPM]	Enter the maximum limit for motor speed. The Motor Speed High Limit can be set to correspond to the manufacturer's maximum rated motor. The Motor Speed High Limit must exceed the setting in 4-11 Motor Speed Low Limit [RPM]. Only 4-11 Motor Speed Low Limit [RPM] or 4-12 Motor Speed Low Limit [Hz] will be displayed depending on other parameters in the Main Menu and depending on default settings dependant on global location.	

NOTE

Max. output frequency cannot exceed 10% of the inverter switching frequency (14-01 Switching Frequency).

NOTE

Any changes in 4-13 Motor Speed High Limit [RPM] will reset the value in 4-53 Warning Speed High to the same value as set in 4-13 Motor Speed High Limit [RPM].

4-14 Motor Speed High Limit [Hz]		
Range:	Function:	
Size related* [par. 4-12 - par. 4-19 Hz]	Enter the maximum limit for motor speed. The Motor Speed High Limit can be set to correspond to the manufacturer's recommended maximum of the motor shaft. The Motor Speed High Limit must exceed the in 4-12 Motor Speed Low Limit [Hz]. Only 4-13 Motor Speed High Limit [RPM] or 4-14 Motor Speed High Limit [Hz] will be displayed depending on other parameters in the Main Menu and depending on default settings dependant on global location.	

NOTE

Max. output frequency cannot exceed 10% of the inverter switching frequency (14-01 Switching Frequency).

4-16 Torque Limit Motor Mode		
Range:		Function:
110 %*	[0 - 1000.0 %]	Enter the maximum torque limit for motor operation. The torque limit is active in the speed range up to and including the rated motor speed set in <i>1-25 Motor Nominal Speed</i> . To protect the motor from reaching the stalling torque, the default setting is 1.1 x the rated motor torque (calculated value). See also <i>14-25 Trip Delay at Torque Limit</i> for further details. If a setting in <i>1-00 Configuration Mode</i> to <i>1-28 Motor Rotation Check</i> is changed, <i>4-16 Torque Limit Motor Mode</i> is not automatically reset to the default setting.

4-17 Torque Limit Generator Mode		
Range:		Function:
100 %*	[0 - 1000.0 %]	Enter the maximum torque limit for generator mode operation. The torque limit is active in the speed range up to and including the rated motor speed (<i>1-25 Motor Nominal Speed</i>). Refer to <i>14-25 Trip Delay at Torque Limit</i> for further details. If a setting in <i>1-00 Configuration Mode</i> to <i>1-28 Motor Rotation Check</i> is changed, <i>4-17 Torque Limit Generator Mode</i> is not automatically reset to the default settings.

4-18 Current Limit		
Range:		Function:
Size related*	[1.0 - 1000.0 %]	Enter the current limit for motor and generator operation. To protect the motor from reaching the stalling torque, the default setting is 1.1 x the rated motor current (set in <i>1-24 Motor Current</i>). If a setting in <i>1-00 Configuration Mode</i> to <i>1-28 Motor Rotation Check</i> is changed, <i>4-16 Torque Limit Motor Mode</i> to <i>4-18 Current Limit</i> are not automatically reset to the default settings.

4-19 Max Output Frequency		
Range:		Function:
Size related*	[1 - 1000.0 Hz]	Enter the maximum output frequency value. <i>4-19 Max Output Frequency</i> specifies the absolute limit on the frequency converter output frequency for improved safety in applications where accidental over-speeding must be avoided. This absolute limit applies to all configurations and is independent of the setting in <i>1-00 Configuration Mode</i> . This parameter cannot be adjusted while the motor is running.

4-19 Max Output Frequency		
Range:		Function:
		When <i>1-10 Motor Construction</i> is set to [1] PM non salient SPM the maximum value is limited to 300 Hz.

3.6.3 4-5* Adj. Warnings

Define adjustable warning limits for current, speed, reference and feedback.

NOTE

Not visible in display, only in .

Warnings are shown on display, programmed output or serial bus.

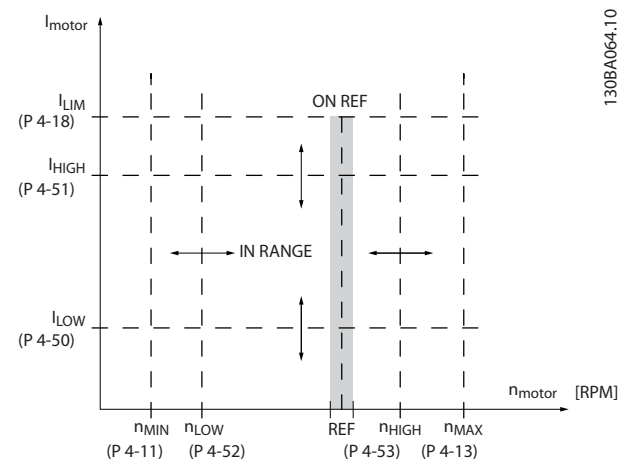

Illustration 3.20

4-50 Warning Current Low		
Range:		Function:
0 A*	[0 - par. 4-51 A]	Enter the I_{LOW} value. When the motor current falls below this limit (I_{LOW}), the display reads CURRENT LOW. The signal outputs can be programmed to produce a status signal on terminal 27 or 29 and on relay output 01 or 02. Refer to <i>Illustration 3.20</i> .

4-51 Warning Current High		
Range:		Function:
Size related*	[par. 4-50 - par. 16-37 A]	Enter the I_{HIGH} value. When the motor current exceeds this limit (I_{HIGH}), the display reads CURRENT HIGH. The signal outputs can be programmed to produce a status signal on terminal 27 or 29 and on relay output 01 or 02. Refer to <i>Illustration 3.20</i> .

4-52 Warning Speed Low		
Range:	Function:	
0 RPM* [0 - par. 4-53 RPM]	Enter the n_{LOW} value. When the motor speed falls below this limit (n_{LOW}) the display reads SPEED LOW. The signal outputs can be programmed to produce a status signal on terminal 27 or 29 and on relay output 01 or 02. Programme the lower signal limit of the motor speed, n_{LOW} , within the normal working range of the frequency converter. Refer to the drawing in this section.	

4-53 Warning Speed High		
Range:	Function:	
Size related* [par. 4-52 - par. 4-13 RPM]	Enter the n_{HIGH} value. When the motor speed exceeds this limit (n_{HIGH}), the display reads SPEED HIGH. The signal outputs can be programmed to produce a status signal on terminal 27 or 29 and on relay output 01 or 02. Programme the upper signal limit of the motor speed, n_{HIGH} , within the normal working range of the frequency converter. Refer to <i>Illustration 3.20</i> .	

NOTE

Any changes in *4-13 Motor Speed High Limit [RPM]* will reset the value in *4-53 Warning Speed High* to the same value as set in *4-13 Motor Speed High Limit [RPM]*.

If a different value is needed in *4-53 Warning Speed High*, it must be set after programming of *4-13 Motor Speed High Limit [RPM]*

4-54 Warning Reference Low		
Range:	Function:	
-999999 * [-999999.999 - par. 4-55]	Enter the lower reference limit. When the actual reference falls below this limit, the display indicates Ref_{Low} . The signal outputs can be programmed to produce a status signal on terminal 27 or 29 and on relay output 01 or 02.	

4-55 Warning Reference High		
Range:	Function:	
999999 * [par. 4-54 - 999999.999]	Enter the upper reference limit. When the actual reference exceeds this limit, the display reads Ref_{High} . The signal outputs can be programmed to produce a status signal on terminal 27 or 29 and on relay output 01 or 02.	

4-56 Warning Feedback Low		
Range:	Function:	
-999999 ReferenceFeedbackUnit* [-999999.999 - par. 4-57 ReferenceFeedbackUnit]	Enter the lower feedback limit. When the feedback falls below this limit, the display reads $Feed_{Low}$. The signal outputs can be programmed to produce a status signal on terminal 27 or 29 and on relay output 01 or 02.	

4-57 Warning Feedback High		
Range:	Function:	
999999 ReferenceFeedbackUnit* [par. 4-56 - 999999.999 ReferenceFeedbackUnit]	Enter the upper feedback limit. When the feedback exceeds this limit, the display reads $Feed_{High}$. The signal outputs can be programmed to produce a status signal on terminal 27 or 29 and on relay output 01 or 02.	

4-58 Missing Motor Phase Function		
Option:	Function:	
[0]	Disabled	No alarm is displayed if a missing motor phase occurs.
[2] *	Trip 1000 ms	

NOTE

This parameter cannot be adjusted while the motor is running.

3.6.4 4-6* Speed Bypass

Some systems call for avoiding certain output frequencies or speeds, due to resonance problems in the system. A maximum of four frequency or speed ranges can be avoided.

4-60 Bypass Speed From [RPM]		
Range:	Function:	
Array [4]		
Size related* [0 - par. 4-13 RPM]	Some systems call for avoiding certain output speeds due to resonance problems in the system. Enter the lower limits of the speeds to be avoided.	

4-61 Bypass Speed From [Hz]		
Array [4]		
Range:		Function:
Size related*	[0 - par. 4-14 Hz]	Some systems call for avoiding certain output speeds due to resonance problems in the system. Enter the lower limits of the speeds to be avoided.

4-62 Bypass Speed To [RPM]		
Array [4]		
Range:		Function:
Size related*	[0 - par. 4-13 RPM]	Some systems call for avoiding certain output speeds due to resonance problems in the system. Enter the upper limits of the speeds to be avoided.

4-63 Bypass Speed To [Hz]		
Array [4]		
Range:		Function:
Size related*	[0 - par. 4-14 Hz]	Some systems call for avoiding certain output speeds due to resonance problems in the system. Enter the upper limits of the speeds to be avoided.

4-64 Semi-Auto Bypass Set-up		
Option:		Function:
[0] *	Off	No function
[1]	Enabled	Starts the Semi-Automatic Bypass set-up and continue with the procedure described above.

3.7 Main Menu - Digital In/Out - Group 5

Parameter group for configuring the digital input and output.

3.7.1 5-0* Digital I/O Mode

Parameters for configuring the input and output using NPN and PNP.

5-00 Digital I/O Mode		
Option:	Function:	
		Digital inputs and programmed digital outputs are pre-programmable for operation either in PNP or NPN systems.
[0] *	PNP - Active at 24V	Action on positive directional pulses (0). PNP systems are pulled down to GND.
[1]	NPN - Active at 0V	Action on negative directional pulses (1). NPN systems are pulled up to +24 V, internally in the frequency converter.

NOTE

This parameter cannot be changed while the motor is running.

5-01 Terminal 27 Mode		
Option:	Function:	
[0] *	Input	Defines terminal 27 as a digital input.

Digital input function	Select	Terminal
No operation	[0]	All *term 32, 33
Reset	[1]	All
Coast inverse	[2]	All
Coast and reset inverse	[3]	All
DC-brake inverse	[5]	All
Stop inverse	[6]	All
External interlock	[7]	All
Start	[8]	All *term 18
Latched start	[9]	All
Reversing	[10]	All *term 19
Start reversing	[11]	All
Jog	[14]	All *term 29
Preset reference on	[15]	All
Preset ref bit 0	[16]	All
Preset ref bit 1	[17]	All
Preset ref bit 2	[18]	All
Freeze reference	[19]	All
Freeze output	[20]	All
Speed up	[21]	All
Speed down	[22]	All
Set-up select bit 0	[23]	All
Set-up select bit 1	[24]	All
Ramp bit 0	[34]	All
Mains failure inverse	[36]	All

5-01 Terminal 27 Mode		
Option:	Function:	
[1]	Output	Defines terminal 27 as a digital output.

NOTE

This parameter cannot be changed while the motor is running.

5-02 Terminal 29 Mode		
Option:	Function:	
[0] *	Input	Defines terminal 29 as a digital input.
[1]	Output	Defines terminal 29 as a digital output.

NOTE

This parameter cannot be changed while the motor is running.

3.7.2 5-1* Digital Inputs

Parameters for configuring the input functions for the input terminals.

The digital inputs are used for selecting various functions in the frequency converter. All digital inputs can be set to the following functions:

Fire mode	[37]	
Day/ Night Control	[39]	
Run Permissive	[52]	
Hand start	[53]	
Auto start	[54]	
DigiPot Increase	[55]	All
DigiPot Decrease	[56]	All
DigiPot Clear	[57]	All
Reset Counter A	[62]	All
Reset Counter B	[65]	All
Sleep Mode	[66]	
Reset Maintenance Word	[78]	
Lead Compressor Start	[120]	
Lead Compressor Alternation	[121]	
Compressor 1 Interlock	[130]	
Compressor 2 Interlock	[131]	
Compressor 3 Interlock	[132]	
Comp. 1 Inv. Interlock	[139]	
Comp. 2 Inv. Interlock	[140]	
Comp. 3 Inv. Interlock	[141]	

Table 3.9

All = Terminals 18, 19, 27, 29, 32, X30/2, X30/3, X30/4. X30/ are the terminals on MCB 101.

Functions dedicated to only one digital input are stated in the associated parameter.

All digital inputs can be programmed to these functions:

[0]	No operation	No reaction to signals transmitted to terminal.
[1]	Reset	Resets frequency converter after a TRIP/ ALARM. Not all alarms can be reset.
[2]	Coast inverse	Leaves motor in free mode. Logic '0' ⇒ coasting stop. (Default Digital input 27): Coasting stop, inverted input (NC).
[3]	Coast and reset inverse	Reset and coasting stop Inverted input (NC). Leaves motor in free mode and resets the frequency converter. Logic '0' ⇒ coasting stop and reset.
[5]	DC-brake inverse	Inverted input for DC braking (NC). Stops motor by energizing it with a DC current for a certain time period. See 2-01 DC Brake Current to 2-03 DC Brake Cut In Speed [RPM]. The function is only active when the value in 2-02 DC Braking Time is different from 0. Logic '0' ⇒ DC braking.
[6]	Stop inverse	Stop Inverted function. Generates a stop function when the selected terminal goes from logical level '1' to '0'. The stop is performed according to the selected ramp time (3-42 Ramp 1 Ramp Down Time, 3-52 Ramp 2 Ramp Down Time, 3-62 Ramp 3

Ramp down Time, 3-72 Ramp 4 Ramp Down Time).

NOTE

When the frequency converter is at the torque limit and has received a stop command, it may not stop by itself. To ensure that the frequency converter stops, configure a digital output to [27] Torque limit & stop and connect this digital output to a digital input that is configured as coast.

[7]	External Interlock	Same function as Coasting stop, inverse, but External Interlock generates the alarm message 'external fault' on the display when the terminal which is programmed for Coast Inverse is logic '0'. The alarm message will also be active via digital outputs and relay outputs, if programmed for External Interlock. The alarm can be reset using a digital input or the [Reset] key if the cause for the External Interlock has been removed. A delay can be programmed in 22-00 External Interlock Delay. After applying a signal to the input, the reaction described above will be delayed with the time set in 22-00 External Interlock Delay.
[8]	Start	Select start for a start/stop command. Logic '1' = start, logic '0' = stop. (Default Digital input 18)
[9]	Latched start	Motor starts, if a pulse is applied for min. 2 ms. Motor stops when Stop inverse is activated

[10]	Reversing	Changes direction of motor shaft rotation. Select Logic '1' to reverse. The reversing signal only changes the direction of rotation. It does not activate the start function. Select both directions in <i>4-10 Motor Speed Direction</i> . (Default Digital input 19).																																				
[11]	Start reversing	Used for start/stop and for reversing on the same wire. Signals on start are not allowed at the same time.																																				
[14]	Jog	Used for activating jog speed. See <i>3-11 Jog Speed [Hz]</i> . (Default Digital input 29)																																				
[15]	Preset reference on	Used for shifting between external reference and preset reference. It is assumed that <i>External/preset [1]</i> has been selected in <i>3-04 Reference Function</i> . Logic '0' = external reference active; logic '1' = one of the eight preset references is active.																																				
[16]	Preset ref bit 0	Enables a choice between one of the eight preset references according to the table below.																																				
[17]	Preset ref bit 1	Enables a choice between one of the eight preset references according to the table below.																																				
[18]	Preset ref bit 2	Enables a choice between one of the eight preset references according to <i>Table 3.10</i> . <table border="1" style="margin-left: 20px;"> <thead> <tr> <th>Preset ref. bit</th> <th>2</th> <th>1</th> <th>0</th> </tr> </thead> <tbody> <tr> <td>Preset ref. 0</td> <td>0</td> <td>0</td> <td>0</td> </tr> <tr> <td>Preset ref. 1</td> <td>0</td> <td>0</td> <td>1</td> </tr> <tr> <td>Preset ref. 2</td> <td>0</td> <td>1</td> <td>0</td> </tr> <tr> <td>Preset ref. 3</td> <td>0</td> <td>1</td> <td>1</td> </tr> <tr> <td>Preset ref. 4</td> <td>1</td> <td>0</td> <td>0</td> </tr> <tr> <td>Preset ref. 5</td> <td>1</td> <td>0</td> <td>1</td> </tr> <tr> <td>Preset ref. 6</td> <td>1</td> <td>1</td> <td>0</td> </tr> <tr> <td>Preset ref. 7</td> <td>1</td> <td>1</td> <td>1</td> </tr> </tbody> </table> <p style="text-align: center;">Table 3.10</p>	Preset ref. bit	2	1	0	Preset ref. 0	0	0	0	Preset ref. 1	0	0	1	Preset ref. 2	0	1	0	Preset ref. 3	0	1	1	Preset ref. 4	1	0	0	Preset ref. 5	1	0	1	Preset ref. 6	1	1	0	Preset ref. 7	1	1	1
Preset ref. bit	2	1	0																																			
Preset ref. 0	0	0	0																																			
Preset ref. 1	0	0	1																																			
Preset ref. 2	0	1	0																																			
Preset ref. 3	0	1	1																																			
Preset ref. 4	1	0	0																																			
Preset ref. 5	1	0	1																																			
Preset ref. 6	1	1	0																																			
Preset ref. 7	1	1	1																																			
[19]	Freeze ref	Freezes actual reference. The frozen reference is now the point of enable/condition for Speed up and Speed down to be used. If Speed up/down is used, the speed change always follows ramp 2 (<i>3-51 Ramp 2 Ramp Up Time</i> and <i>3-52 Ramp 2 Ramp Down Time</i>) in the range 0 - <i>3-03 Maximum Reference</i> .																																				
[20]	Freeze output	Freezes actual motor frequency (Hz). The frozen motor frequency is now the point of enable/condition for Speed up and Speed down to be used. If Speed up/down is used, the speed change always follows ramp 2 (<i>3-51 Ramp 2 Ramp Up Time</i> and <i>3-52 Ramp 2 Ramp Down Time</i>) in the range 0 - <i>1-23 Motor Frequency</i> .																																				

NOTE

When Freeze output is active, the frequency converter cannot be stopped via a low 'start [13]' signal. Stop the frequency converter via a terminal programmed for [2] Coast inverse or [3] Coast and reset, inv.

[21]	Speed up	For digital control of the up/down speed is desired (motor potentiometer). Activate this function by selecting either Freeze reference or Freeze output. When Speed up is activated for less than 400 ms the resulting reference will be increased by 0.1 %. If Speed up is activated for more than 400 ms the resulting reference will ramp according to Ramp 1 in <i>3-41 Ramp 1 Ramp Up Time</i> .
[22]	Speed down	Same as [21] Speed up.
[23]	Set-up select bit 0	Selects one of the four set-ups. Set <i>0-10 Active Set-up</i> to Multi Set-up.
[24]	Set-up select bit 1	Same as [23] Set-up select bit 0. (Default Digital input 32)
[34]	Ramp bit 0	Select which ramp to use. Logic "0" will select ramp 1 while logic "1" will select ramp 2.
[37]	Fire mode	A signal applied will put the frequency converter into Fire Mode and all other commands will be disregarded. See <i>24-0* Fire Mode</i> .
[39]	Day/ Night Control	Day or night indication for Day-Night control feature. A low voltage on the selected digital input indicates day, while high voltage indicates night.
[52]	Run Permissive	The input terminal, for which the Run permissive has been programmed must be logic "1" before a start command can be accepted. Run permissive has a logic 'AND' function related to the terminal which is programmed for [8] Start, [14] Jog or [20] Freeze Output, which means that in order to start running the motor, both conditions must be fulfilled. If Run Permissive is programmed on multiple terminals, Run permissive needs only be logic '1' on one of the terminals for the function to be carried out. The digital output signal for Run Request ([8] Start, [14] Jog or [20] Freeze output) programmed in parameter group 5-3* Digital outputs, or parameter group 5-4* Relays, will not be affected by Run Permissive.
[53]	Hand start	A signal applied will put the frequency converter into Hand mode as if [Hand On] on the LCP has been pressed and a normal stop command will be overridden. If disconnecting the signal, the motor will stop. To make any other start commands valid,

		another digital input must be assign to <i>Auto Start</i> and a signal applied to this. <i>[Hand On]</i> and <i>[Auto On]</i> have no impact. <i>[Off]</i> will override <i>Hand Start</i> and <i>Auto Start</i> . Press either <i>[Hand On]</i> or <i>[Auto On]</i> to make <i>Hand Start</i> and <i>Auto Start</i> active again. If no signal on neither <i>Hand Start</i> nor <i>Auto Start</i> , the motor will stop regardless of any normal Start command applied. If signal applied to both <i>Hand Start</i> and <i>Auto Start</i> , the function will be <i>Auto Start</i> . If pressing <i>[Off]</i> the motor will stop regardless of signals on <i>Hand Start</i> and <i>Auto Start</i> .
[54]	Auto start	A signal applied will put the frequency converter into Auto mode as if <i>[Auto On]</i> has been pressed. See also [53] <i>Hand Start</i> .
[55]	DigiPot Increase	Uses the input as an INCREASE signal to the Digital Potentiometer function described in parameter group 3-9*
[56]	DigiPot Decrease	Uses the input as a DECREASE signal to the Digital Potentiometer function described in parameter group 3-9*
[57]	DigiPot Clear	Uses the input to CLEAR the Digital Potentiometer reference described in parameter group 3-9*
[62]	Reset Counter A	Input for reset of counter A.
[65]	Reset Counter B	Input for reset of counter B.
[66]	Sleep Mode	Forces frequency converter into Sleep Mode (see parameter group 22-4*, Sleep Mode). Reacts on the rising edge of signal applied!
[78]	Reset Preventive Maintenance Word	Resets all data in <i>16-96 Maintenance Word</i> , to 0.

The below setting options are all related to the Cascade Controller. Wiring diagrams and settings for parameter, see parameter group 25-** for more details.

[120]	Lead Compressor Start	Starts/Stops the Lead Compressor (controlled by the frequency converter). A start requires that also a System Start signal has been applied e.g. to one of the digital inputs set for [8] <i>Start!</i>
[121]	Lead Compressor Alternation	Forces alternation of the lead Compressor in a Cascade Controller. <i>Lead Compressor Alternation</i> , 25-50, must be set to either [2] <i>At Command</i> or [3] <i>At Staging or At Command</i> . 25-51 <i>Alternation Event</i> can be set to any of the four options.
[130 - 132]	Compressor 1 Interlock - Compressor 3 Interlock	For all 3 setting options below, 25-90 <i>Compressor Interlock</i> , must be set to [1] <i>On</i> . The function will also depend on the setting in 25-06, Fixed Lead Compressor. If set to [0] <i>No</i> , then

		Compressor 1 refers to the Compressor controlled by relay RELAY1 etc. If set to [1] Yes, Compressor 1 refers to the Compressor controlled by the frequency converter only (without any of the build in relays involved) and Compresso r2 to the Compressor controlled by the relay RELAY1. Variable speed Compressor (lead) cannot be interlocked. See below table:														
		<table border="1"> <thead> <tr> <th rowspan="2">Setting in parameter group 5-1*</th> <th colspan="2">Setting in par. 25-06</th> </tr> <tr> <th>[0] No</th> <th>[1] Yes</th> </tr> </thead> <tbody> <tr> <td>[130] Compressor 1 Interlock</td> <td>Controlled by RELAY1 (only if not lead Compressor)</td> <td>Frequency Converter controlled (cannot be interlocked)</td> </tr> <tr> <td>[131] Compressor2 Interlock</td> <td>Controlled by RELAY2</td> <td>Controlled by RELAY1</td> </tr> <tr> <td>[132] Compressor3 Interlock</td> <td>Controlled by RELAY3</td> <td>Controlled by RELAY2</td> </tr> </tbody> </table>	Setting in parameter group 5-1*	Setting in par. 25-06		[0] No	[1] Yes	[130] Compressor 1 Interlock	Controlled by RELAY1 (only if not lead Compressor)	Frequency Converter controlled (cannot be interlocked)	[131] Compressor2 Interlock	Controlled by RELAY2	Controlled by RELAY1	[132] Compressor3 Interlock	Controlled by RELAY3	Controlled by RELAY2
Setting in parameter group 5-1*	Setting in par. 25-06															
	[0] No	[1] Yes														
[130] Compressor 1 Interlock	Controlled by RELAY1 (only if not lead Compressor)	Frequency Converter controlled (cannot be interlocked)														
[131] Compressor2 Interlock	Controlled by RELAY2	Controlled by RELAY1														
[132] Compressor3 Interlock	Controlled by RELAY3	Controlled by RELAY2														
		Table 3.11														
[139]	Compressor 1 Inverse Interlock	Interlocks compressor 1 of the Pack Controller when digitally low and issues Warning [W219]. When inversely interlocked, compressor 1 (the lead compressor) is staging according to the Fixed Speed Neutral Zone (25-23).														
[140]	Compressor 2 Inverse Interlock	Interlocks compressor 2 of the Pack Controller when digitally low and issues Warning [W219].														
[141]	Compressor 3 Inverse Interlock	Interlocks compressor 3 of the Pack Controller when digitally low and issues Warning [W219].														

5-10 Terminal 18 Digital Input

Option: **Function:**

[8] *	Start	Functions are described under parameter group 5-1*
-------	-------	--

5-11 Terminal 19 Digital Input

Option: **Function:**

[10] *	Reversing	Functions are described under parameter group 5-1*
--------	-----------	--

5-12 Terminal 27 Digital Input

Option: **Function:**

[2] *	Coast inverse	Functions are described under parameter group 5-1*
-------	---------------	--

5-13 Terminal 29 Digital Input
Option: Function:

		Select the function from the available digital input range and the additional options [60], [61], [63] and [64]. Counters are used in Smart Logic Control functions.
[0] *	No operation	Functions are described under parameter group 5-1*

5-14 Terminal 32 Digital Input
Option: Function:

		Select the function from the available digital input range and the additional options [60], [61], [63] and [64]. Counters are used in Smart Logic Control functions.
[39] *	Day/Night control	Functions are described under parameter group 5-1*

5-15 Terminal 33 Digital Input
Option: Function:

		Select the function from the available digital input range and the additional options [60], [61], [63] and [64]. Counters are used in Smart Logic Control functions.
[0] *	No operation	Functions are described under parameter group 5-1*

5-16 Terminal X30/2 Digital Input
Option: Function:

[0] *	No operation	This parameter is active when option module MCB101 is installed in the frequency converter. Functions are described under parameter group 5-1*
-------	--------------	--

5-17 Terminal X30/3 Digital Input
Option: Function:

[0] *	No operation	This parameter is active when option module MCB101 is installed in the frequency converter. Functions are described under parameter group 5-1*
-------	--------------	--

5-18 Terminal X30/4 Digital Input
Option: Function:

[0] *	No operation	This parameter is active when option module MCB101 is installed in the frequency converter. Functions are described under parameter group 5-1*
-------	--------------	--

5-19 Terminal 37 Safe Stop
Option: Function:

[1] *	Safe Stop Alarm	Coasts frequency converter when safe stop is activated. Manual reset from LCP, digital input or fieldbus.
[3]	Safe Stop Warning	Coasts frequency converter when safe stop is activated (T-37 off). When safe stop circuit is reestablished, the frequency

5-19 Terminal 37 Safe Stop
Option: Function:

		converter will continue without manual reset.
--	--	---

Choices 4 - 9 are only available when the MCB 112 PTC Thermistor Card is connected.

NOTE

When Auto Reset/Warning is selected the frequency converter opens up for automatic restart.

Overview of functions, alarms and warnings

Function	No.	PTC	Relay
No Function	[0]	-	-
Safe Stop Alarm	[1]*	-	Safe Stop [A68]
Safe Stop Warning	[3]	-	Safe Stop [W68]
PTC 1 Alarm	[4]	PTC 1 Safe Stop [A71]	-
PTC 1 Warning	[5]	PTC 1 Safe Stop [W71]	-
PTC 1 & Relay A	[6]	PTC 1 Safe Stop [A71]	Safe Stop [A68]
PTC 1 & Relay W	[7]	PTC 1 Safe Stop [W71]	Safe Stop [W68]
PTC 1 & Relay A/W	[8]	PTC 1 Safe Stop [A71]	Safe Stop [W68]
PTC 1 & Relay W/A	[9]	PTC 1 Safe Stop [W71]	Safe Stop [A68]

Table 3.12

W means warning and A means alarm. For further information, see Alarms and Warnings in section Troubleshooting in the Design Guide or the Operating Instructions

A dangerous failure related to Safe Stop will give Alarm: Dangerous Failure [A72].

Refer to Table 5.3 in .

3.7.3 5-3* Digital Outputs

Parameters for configuring the output functions for the output terminals. The 2 solid-state digital outputs are common for terminals 27 and 29. Set the I/O function for terminal 27 in *5-01 Terminal 27 Mode*, and set the I/O function for terminal 29 in *5-02 Terminal 29 Mode*. These parameters cannot be adjusted while the motor is running.

		The digital outputs can be programmed with these functions:
[0]	No operation	Default for all digital outputs and relay outputs
[1]	Control ready	The control board receives supply voltage.

[2]	Drive ready	The frequency converter is ready for operation and applies a supply signal on the control board.
[3]	Drive ready / remote control	The frequency converter is ready for operation and is in Auto On mode.
[4]	Stand-by / no warning	The frequency converter is ready for operation. No start or stop command is been given (start/disable). There are no warnings.
[5]	Running	The motor is running.
[6]	Running / no warning	The output speed is higher than the speed set in <i>1-81 Min Speed for Function at Stop [RPM]</i> . The motor is running and there are no warnings.
[8]	Run on reference / no warning	The motor runs at reference speed.
[9]	Alarm	An alarm activates the output. There are no warnings.
[10]	Alarm or warning	An alarm or a warning activates the output.
[11]	At torque limit	The torque limit set in <i>4-16 Torque Limit Motor Mode</i> or <i>1-17 Voltage filter time const.</i> has been exceeded.
[12]	Out of current range	The motor current is outside the range set in <i>4-18 Current Limit</i> .
[13]	Below current, low	The motor current is lower than set in <i>4-50 Warning Current Low</i> .
[14]	Above current, high	The motor current is higher than set in <i>4-51 Warning Current High</i> .
[15]	Out of speed range	The output speed is outside the range set in <i>4-52 Warning Speed Low</i> and <i>4-53 Warning Speed High</i> .
[16]	Below speed, low	The output speed is lower than the setting in <i>4-52 Warning Speed Low</i> .
[17]	Above speed, high	The output speed is higher than the setting in <i>4-53 Warning Speed High</i> .
[18]	Out of feedback range	The feedback is outside the range set in <i>4-56 Warning Feedback Low</i> and <i>4-57 Warning Feedback High</i> .
[19]	Below feedback low	The feedback is below the limit set in <i>4-56 Warning Feedback Low</i> .
[20]	Above feedback high	The feedback is above the limit set in <i>4-57 Warning Feedback High</i> .
[21]	Thermal warning	The thermal warning turns on when the temperature exceeds the limit in the motor, the frequency converter, the brake resistor, or the thermistor.
[25]	Reverse	<i>Reversing. Logic '1' = relay activated, 24 V DC when CW rotation of the motor. Logic '0' = relay not activated, no signal, when CCW rotation of the motor.</i>
[26]	Bus OK	Active communication (no time-out) via the serial communication port.
[27]	Torque limit and stop	Use in performing a coasting stop and in torque limit condition. If the frequency

		converter has received a stop signal and is at the torque limit, the signal is Logic '0'.
[28]	Brake, no warning	The brake is active and there are no warnings.
[29]	Brake ready, no fault	The brake is ready for operation and there are no faults.
[30]	Brake fault (IGBT)	The output is Logic '1' when the brake IGBT is short-circuited. Use this function to protect the frequency converter if there is a fault on the brake modules. Use the output/relay to cut out the main voltage from the frequency converter.
[35]	External Interlock	External Interlock function has been activated via one of the digital inputs.
[40]	Out of ref range	
[41]	Below reference low	
[42]	Above reference high	
[45]	Bus Ctrl	
[46]	Bus Ctrl 1 if timeout	
[47]	Bus Ctrl 0 if timeout	
[55]	Pulse output	
[60]	Comtor 0	See parameter group 13-1*. If Comtor 0 is evaluated as TRUE, the output will go high. Otherwise, it will be low.
[61]	Comtor 1	See parameter group 13-1*. If Comtor 2 is evaluated as TRUE, the output will go high. Otherwise, it will be low.
[62]	Comtor 2	See parameter group 13-1*. If Comtor 2 is evaluated as TRUE, the output will go high. Otherwise, it will be low.
[63]	Comtor 3	See parameter group 13-1*. If Comtor 3 is evaluated as TRUE, the output will go high. Otherwise, it will be low.
[64]	Comtor 4	See parameter group 13-1*. If Comtor 4 is evaluated as TRUE, the output will go high. Otherwise, it will be low.
[65]	Comtor 5	See parameter group 13-1*. If Comtor 5 is evaluated as TRUE, the output will go high. Otherwise, it will be low.
[70]	Logic Rule 0	See parameter group 13-4*. If Logic Rule 0 is evaluated as TRUE, the output will go high. Otherwise, it will be low.
[71]	Logic Rule 1	See parameter group 13-4*. If Logic Rule 1 is evaluated as TRUE, the output will go high. Otherwise, it will be low.
[72]	Logic Rule 2	See parameter group 13-4*. If Logic Rule 2 is evaluated as TRUE, the output will go high. Otherwise, it will be low.
[73]	Logic Rule 3	See parameter group 13-4*. If Logic Rule 3 is evaluated as TRUE, the output will go high. Otherwise, it will be low.

[74]	Logic Rule 4	See parameter group 13-4*. If Logic Rule 4 is evaluated as TRUE, the output will go high. Otherwise, it will be low.
[75]	Logic Rule 5	See parameter group 13-4*. If Logic Rule 5 is evaluated as TRUE, the output will go high. Otherwise, it will be low.
[80]	SL Digital Output A	See 13-52 <i>SL Controller Action</i> . The input will go high whenever the Smart Logic Action [38] <i>Set digital out. A high</i> is executed. The input will go low whenever the Smart Logic Action [32] <i>Set digital out. A low</i> is executed.
[81]	SL Digital Output B	See 13-52 <i>SL Controller Action</i> . The input will go high whenever the Smart Logic Action [39] <i>Set digital out. B high</i> is executed. The input will go low whenever the Smart Logic Action [33] <i>Set digital out. B low</i> is executed.
[82]	SL Digital Output C	See 13-52 <i>SL Controller Action</i> . The input will go high whenever the Smart Logic Action [40] <i>Set digital out. C high</i> is executed. The input will go low whenever the Smart Logic Action [34] <i>Set dig. out. C low</i> is executed.
[83]	SL Digital Output D	See 13-52 <i>SL Controller Action</i> . The input will go high whenever the Smart Logic Action [41] <i>Set digital out. D high</i> is executed. The input will go low whenever the Smart Logic Action [35] <i>Set digital out. D low</i> is executed.
[84]	SL Digital Output E	See 13-52 <i>SL Controller Action</i> . The input will go high whenever the Smart Logic Action [42] <i>Set digital out. E high</i> is executed. The input will go low whenever the Smart Logic Action [36] <i>Set digital out. E low</i> is executed.
[85]	SL Digital Output F	See 13-52 <i>SL Controller Action</i> . The input will go high whenever the Smart Logic Action [43] <i>Set digital out. F high</i> is executed. The input will go low whenever the Smart Logic Action [37] <i>Set digital out. F low</i> is executed.
[160]	No alarm	The output is high when no alarm is present.
[161]	Running reverse	The output is high when the frequency converter is running counter clockwise (the logical product of the status bits 'running' AND 'reverse').
[165]	Local reference active	The output is high when 3-13 <i>Reference Site</i> = [2] <i>Local</i> or when 3-13 <i>Reference Site</i> = [0] <i>Linked to Hand/Auto</i> at the same time as the LCP is in Hand on mode.
[166]	Remote reference active	The output is high when 3-13 <i>Reference Site</i> = [1] <i>Remote</i> or [0] <i>Linked to Hand/Auto</i> while the LCP is in [Auto On] mode.

[167]	Start command active	The output is high when there is an active Start command (i.e. via digital input bus connection or [Hand On] or [Auto On], and no Stop or Start command is active.
[168]	Drive in hand mode	The output is high when the frequency converter is in Hand on mode (as indicated by the LED light above [Hand On]).
[169]	Drive in auto mode	The output is high when the frequency converter is in Hand on mode (as indicated by the LED light above [Auto On]).
[180]	Clock Fault	The clock function has been reset to default (2000-01-01) because of a power failure.
[181]	Preventive Maintenance	One or more of the Preventive Maintenance Events programmed in 23-10 <i>Maintenance Item</i> , has passed the time for the specified action in 23-11 <i>Maintenance Action</i> .
[190]	No-Flow	A No-Flow situation or Minimum Speed situation has been detected if enabled in 22-21 <i>Low Power Detection</i> and/or 22-22 <i>Low Speed Detection</i> .
[191]	Dry Pump	A Dry Pump condition has been detected. This function must be enabled in 22-26 <i>Dry Pump Function</i> .
[192]	End of Curve	A pump running with max. speed for a period of time without reaching the set pressure has been detected. To enable this function, see 22-50 <i>End of Curve Function</i> .
[193]	Sleep Mode	The frequency converter/system has turned into sleep mode. See parameter group 22-4* <i>Sleep Mode</i> .
[194]	Broken Belt	A Broken Belt condition has been detected. This function must be enabled in 22-60 <i>Broken Belt Function</i> .
[195]	Bypass Valve Control	The bypass valve control (Digital / Relay output in the frequency converter) is used for compressor systems to unload the compressor during start-up by using a bypass valve. After the start command is given the bypass valve will be open until the frequency converter reaches 4-11 <i>Motor Speed Low Limit [RPM]</i> . After the limit has been reached the bypass valve will be closed, allowing the compressor to operate normally. This procedure will not be activated again before a new start is initiated and the frequency converter speed is zero during the receiving of start signal. 1-71 <i>Start Delay</i> can be used in order to delay the motor start. The Bypass valve control principle:

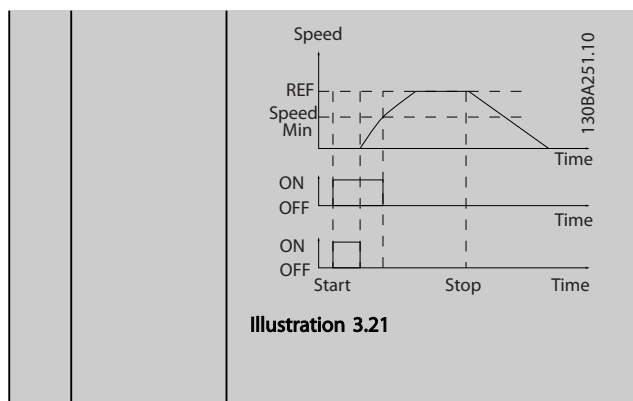

[196]	Fire Mode	The frequency converter is operating in Fire Mode. See 24-0* <i>Fire Mode</i> .
[197]	Fire Mode was act.	The frequency converter has been operating in Fire Mode, but is now back in normal operation.
[198]	Drive Bypass	To be used as signal for activating an external electromechanical bypass switching the motor direct on line. See 24-1* <i>Drive Bypass</i> . ⚠ CAUTION If enabling the Drive Bypass Function, the frequency converter is no longer Safety Certified (for using the Safe Stop in versions where included).

[199]	Injection Control	Indicates that the digital output is used for providing Injection ON-OFF signal. A low voltage on the selected digital output indicates Injection OFF, while high voltage indicates Injection ON.
-------	-------------------	---

The below setting options are all related to the Cascade Controller.

Wiring diagrams and settings for meter, see parameter group 25-** for more details.

[200]	Full Capacity	All pumps running and at full speed
[201]	Compressor 1 Running	One or more of the compressors controlled by the Cascade Controller are running. The function will also depend on the setting of in <i>Fixed Lead Compressor</i> , 25-06. If set to [0] No Compressor 1 refers to the compressor controlled by relay RELAY1 etc. If set to [1] Yes Compressor 1 refers to the compressor controlled by the frequency converter only (without any of the build in relays involved) and Compressor 2 to the compressor controlled by the relay RELAY1. See <i>Table 3.13</i> :
[202]	Compressor 2 Running	See [201]
[203]	Compressor 3 Running	See [201]

Setting in parameter group 5-3*	Setting in parameter 25-06	
	[0] No	[1] Yes
[201] Compressor 1 Running	Controlled by RELAY1	Frequency Converter controlled
[202] Compressor 2 Running	Controlled by RELAY2	Controlled by RELAY1
[203] Compressor 3 Running	Controlled by RELAY3	Controlled by RELAY2

Table 3.13

5-30 Terminal 27 Digital Output

Option:	Function:
[0] * No operation	Functions are described under parameter group 5-3*

5-31 Terminal 29 Digital Output

Option:	Function:
[0] * No operation	Functions are described under parameter group 5-3*

5-32 Term X30/6 Digi Out (MCB 101)

Option:	Function:
[0] * No operation	This meter is active when option module MCB 101 is mounted in the frequency converter. Functions are described under parameter group 5-3*

5-33 Term X30/7 Digi Out (MCB 101)

Option:	Function:
[0] * No operation	This meter is active when option module MCB 101 is mounted in the frequency converter. Functions are described under parameter group 5-3*

3.7.4 5-4* Relays

Parameters for configuring the timing and the output functions for the relays.

5-40 Function Relay		
Select options to define the function of the relays. The selection of each mechanical relay is realised in an array meter.		
Option:	Function:	
	Array [8] (Relay 1 [0], Relay 2 [1], Option MCB 105: Relay 7 [6], Relay 8 [7] and Relay 9 [8])	
[0] *	No operation	
[1]	Control Ready	
[2]	Drive ready	
[3]	Drive rdy/rem ctrl	
[4]	Standby / no warning	
[5] *	Running	Default setting for relay 2.
[6]	Running / no warning	
[8]	Run on ref/no warn	
[9] *	Alarm	Default setting for relay 1.
[10]	Alarm or warning	
[11]	At torque limit	
[12]	Out of current range	
[13]	Below current, low	
[14]	Above current, high	
[15]	Out of speed range	
[16]	Below speed, low	
[17]	Above speed, high	
[18]	Out of feedb. range	
[19]	Below feedback, low	
[20]	Above feedback, high	
[21]	Thermal warning	
[25]	Reverse	
[26]	Bus OK	
[27]	Torque limit & stop	
[28]	Brake, no brake war	
[29]	Brake ready, no fault	
[30]	Brake fault (IGBT)	
[35]	External Interlock	
[36]	Control word bit 11	
[37]	Control word bit 12	
[40]	Out of ref range	
[41]	Below reference, low	
[42]	Above ref, high	
[45]	Bus ctrl.	
[46]	Bus ctrl, 1 if timeout	
[47]	Bus ctrl, 0 if timeout	
[60]	Comparator 0	
[61]	Comparator 1	
[62]	Comparator 2	
[63]	Comparator 3	
[64]	Comparator 4	
[65]	Comparator 5	
[70]	Logic rule 0	
[71]	Logic rule 1	
[72]	Logic rule 2	

5-40 Function Relay		
Select options to define the function of the relays. The selection of each mechanical relay is realised in an array meter.		
Option:	Function:	
[73]	Logic rule 3	
[74]	Logic rule 4	
[75]	Logic rule 5	
[80]	SL digital output A	
[81]	SL digital output B	
[82]	SL digital output C	
[83]	SL digital output D	
[84]	SL digital output E	
[85]	SL digital output F	
[160]	No alarm	
[161]	Running reverse	
[165]	Local ref active	
[166]	Remote ref active	
[167]	Start command activ	
[168]	Hand mode	
[169]	Auto mode	
[180]	Clock Fault	
[181]	Prev. Maintenance	
[190]	No-Flow	
[191]	Dry Pump	
[192]	End Of Curve	
[193]	Sleep Mode	
[194]	Broken Belt	
[195]	Bypass Valve Control	
[199]	Injection Control	
[211]	Pack Comp. 1	
[212]	Pack Comp. 2	
[213]	Pack Comp. 3	

5-41 On Delay, Relay		
Array [8](Relay 1 [0], Relay 2 [1], Relay 3 [2], Relay 4 [3], Relay 5 [4], Relay 6 [5], Relay 7 [6], Relay 8 [7], Relay 9 [8])		
Range:	Function:	
0.01 s*	[0.01 - 600 s]	Enter the delay of the relay cut-in time. Select one of available mechanical relays and MCB 105 in an array function. See 5-40 Function Relay.

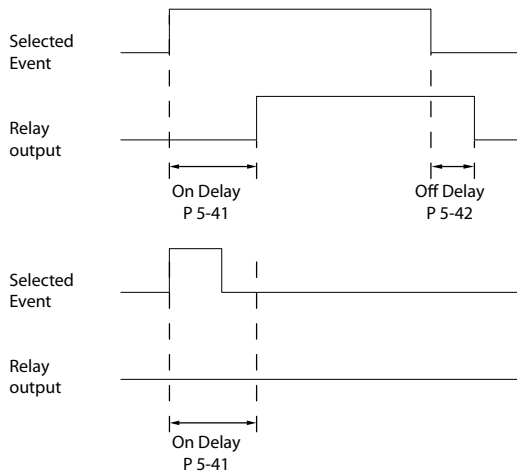

130BA171.10

Illustration 3.22

5-42 Off Delay, Relay		
Array[2]: Relay1[0], Relay2[1]		
Range:	Function:	
0.01 s* [0.01 - 600 s]	Enter the delay of the relay cut-out time. Select one of available mechanical relays and MCB 105 in an array function. See 5-40 Function Relay.	

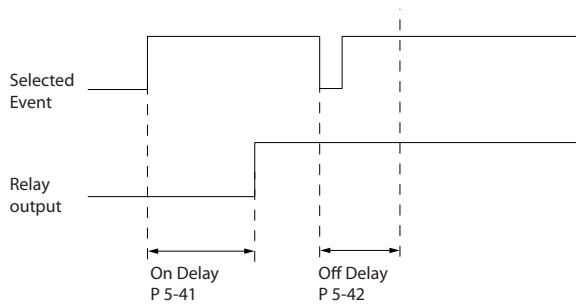

130BA172.10

Illustration 3.23

If the selected Event condition changes before the on- or off delay timer expires, the relay output is unaffected.

3.7.5 5-5* Pulse Input

The pulse input parameters are used to define an appropriate window for the impulse reference area by configuring the scaling and filter settings for the pulse inputs. Input terminals 29 or 33 act as frequency reference inputs. Set terminal 29 (5-13 Terminal 29 Digital Input) or terminal 33 (5-15 Terminal 33 Digital Input) to [32] Pulse input. If terminal 29 is used as an input, then set 5-02 Terminal 29 Mode to [0] Input.

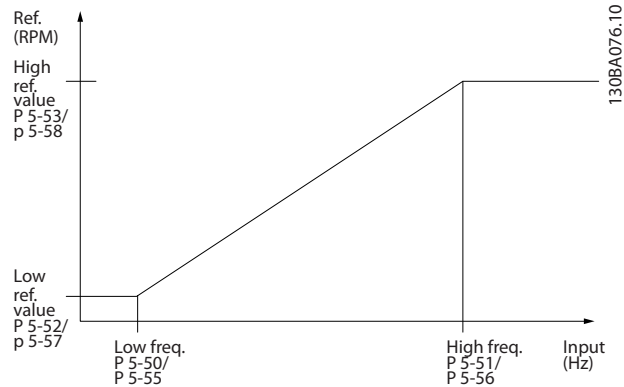

Illustration 3.24

5-50 Term. 29 Low Frequency

Range:	Function:
100 Hz* [0 - 110000 Hz]	Enter the low frequency limit corresponding to the low motor shaft speed (i.e. low reference value) in 5-52 Term. 29 Low Ref./Feedb. Value. Refer to the diagram in this section.

5-51 Term. 29 High Frequency

Range:	Function:
100 Hz* [0 - 110000 Hz]	Enter the high frequency limit corresponding to the high motor shaft speed (i.e. high reference value) in 5-53 Term. 29 High Ref./Feedb. Value.

5-52 Term. 29 Low Ref./Feedb. Value

Range:	Function:
0 * [-999999.999 - 999999.999]	Enter the low reference value limit for the motor shaft speed [RPM]. This is also the lowest feedback value, see also 5-57 Term. 33 Low Ref./Feedb. Value.

5-53 Term. 29 High Ref./Feedb. Value

Range:	Function:
100 * [-999999.999 - 999999.999]	Enter the high reference value [RPM] for the motor shaft speed and the high feedback value, see also 5-58 Term. 33 High Ref./Feedb. Value.

5-54 Pulse Filter Time Constant #29		
Range:	Function:	
100 ms*	[1 - 1000 ms]	Enter the pulse filter time constant. The pulse filter dampens oscillations of the feedback signal, which is an advantage if there is a lot of noise in the system. A high time constant value results in better dampening but also increases the time delay through the filter.
<p>NOTE This meter cannot be adjusted while the motor is running.</p>		

5-55 Term. 33 Low Frequency		
Range:	Function:	
100 Hz*	[0 - 110000 Hz]	Enter the low frequency corresponding to the low motor shaft speed (i.e. low reference value) in 5-57 Term. 33 Low Ref./Feedb. Value.

5-56 Term. 33 High Frequency		
Range:	Function:	
100 Hz*	[0 - 110000 Hz]	Enter the high frequency corresponding to the high motor shaft speed (i.e. high reference value) in 5-58 Term. 33 High Ref./Feedb. Value.

5-57 Term. 33 Low Ref./Feedb. Value		
Range:	Function:	
0 *	[-999999.999 - 999999.999]	Enter the low reference value [RPM] for the motor shaft speed. This is also the low feedback value, see also 5-52 Term. 29 Low Ref./Feedb. Value.

5-58 Term. 33 High Ref./Feedb. Value		
Range:	Function:	
100 *	[-999999.999 - 999999.999]	Enter the high reference value [RPM] for the motor shaft speed. See also 5-53 Term. 29 High Ref./Feedb. Value.

5-59 Pulse Filter Time Constant #33		
Range:	Function:	
100 ms*	[1 - 1000 ms]	Enter the pulse filter time constant. The low-pass filter reduces the influence on and dampens oscillations on the feedback signal from the control. This is an advantage, e.g. if there is a great amount on noise in the system.

NOTE
This parameter cannot be adjusted while the motor is running.

3.7.6 5-6* Pulse Outputs

Parameters for configuring the scaling and output functions of pulse outputs. The pulse outputs are designated to terminals 27 or 29. Select terminal 27 output in 5-01 Terminal 27 Mode and terminal 29 output in 5-02 Terminal 29 Mode.

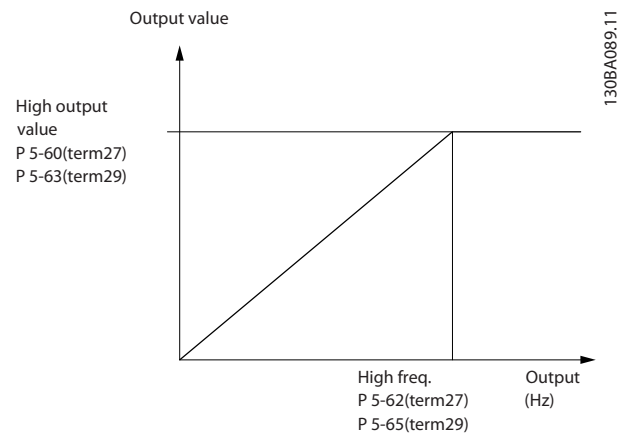

Illustration 3.25

Select the operation variable assigned for terminal 27 readouts. This meter cannot be adjusted while the motor is running. Same options and functions as parameter group 5-6*.

[0] *	No operation
-------	--------------

5-62 Pulse Output Max Freq #27		
Range:	Function:	
		Set the maximum frequency for terminal 27, corresponding to the output variable selected in 5-60 Terminal 27 Pulse Output Variable.
<p>NOTE This meter cannot be adjusted while the motor is running.</p>		
5000 Hz*	[0 - 32000 Hz]	

NOTE
This meter cannot be adjusted while the motor is running.

5-63 Terminal 29 Pulse Output Variable		
Select the variable for viewing on the terminal 29 display. Same options and functions as parameter group 5-6*.		
Option:	Function:	
[0] *	No operation	
[45]	Bus ctrl.	
[48]	Bus ctrl., timeout	

5-63 Terminal 29 Pulse Output Variable		
Select the variable for viewing on the terminal 29 display. Same options and functions as parameter group 5-6*.		
Option:	Function:	
[100]	Output frequency	
[101]	Reference	
[102]	Feedback	
[103]	Motor Current	
[104]	Torque rel to limit	
[105]	Torq relate to rated	
[106]	Power	
[107]	Speed	
[108]	Torque	
[109]	Max Out Freq	
[113]	Ext. Closed Loop 1	
[114]	Ext. Closed Loop 2	
[115]	Ext. Closed Loop 3	

5-65 Pulse Output Max Freq #29		
Set the maximum frequency for terminal 29 corresponding to the output variable set in 5-63 Terminal 29 Pulse Output Variable.		
Range:	Function:	
5000 Hz*	[0 - 32000 Hz]	

5-66 Terminal X30/6 Pulse Output Variable		
Select the variable for read-out on terminal X30/6. This parameter is active when option module MCB 101 is installed in the frequency converter. Same options and functions as parameter group 5-6*.		
Option:	Function:	
[0] *	No operation	
[45]	Bus ctrl.	
[48]	Bus ctrl., timeout	
[100]	Output frequency	
[101]	Reference	
[102]	Feedback	
[103]	Motor Current	
[104]	Torque rel to limit	
[105]	Torq relate to rated	
[106]	Power	
[107]	Speed	
[108]	Torque	
[109]	Max Out Freq	
[113]	Ext. Closed Loop 1	
[114]	Ext. Closed Loop 2	
[115]	Ext. Closed Loop 3	

NOTE

This parameter cannot be adjusted while the motor is running.

5-68 Pulse Output Max Freq #X30/6		
Select the maximum frequency on terminal X30/6 referring to the output variable in 5-66 Terminal X30/6 Pulse Output Variable. This parameter is active when option module MCB 101 is mounted in the frequency converter.		
Range:	Function:	
5000 Hz*	[0 - 32000 Hz]	

3.7.7 5-9* Bus Controlled

This parameter group selects digital and relay outputs via a fieldbus setting.

5-90 Digital & Relay Bus Control		
Range:	Function:	
0 *	[0 - 2147483647]	This meter holds the state of the digital outputs and relays that is controlled by bus. A logical '1' indicates that the output is high or active. A logical '0' indicates that the output is low or inactive.
	Bit 0	CC Digital Output Terminal 27
	Bit 1	CC Digital Output Terminal 29
	Bit 2	GPIO Digital Output Terminal X 30/6
	Bit 3	GPIO Digital Output Terminal X 30/7
	Bit 4	CC Relay 1 output terminal
	Bit 5	CC Relay 2 output terminal
	Bit 6	Option B Relay 1 output terminal
	Bit 7	Option B Relay 2 output terminal
	Bit 8	Option B Relay 3 output terminal
	Bit 9-15	Reserved for future terminals
	Bit 16	Option C Relay 1 output terminal
	Bit 17	Option C Relay 2 output terminal
	Bit 18	Option C Relay 3 output terminal
	Bit 19	Option C Relay 4 output terminal
	Bit 20	Option C Relay 5 output terminal
	Bit 21	Option C Relay 6 output terminal
	Bit 22	Option C Relay 7 output terminal
	Bit 23	Option C Relay 8 output terminal
	Bit 24-31	Reserved for future terminals

Table 3.14

5-93 Pulse Out #27 Bus Control		
Range:	Function:	
0 %*	[0 - 100 %]	Contains the frequency to apply to the digital output terminal 27, when it is configured as [Bus Controlled].

5-94 Pulse Out #27 Timeout Preset		
Range:		Function:
0 %*	[0 - 100 %]	Contains the frequency to apply to the digital output terminal 27, when it is configured as [Bus Controlled Timeout] and timeout is detected.

5-95 Pulse Out #29 Bus Control		
Range:		Function:
0 %*	[0 - 100 %]	Contains the frequency to apply to the digital output terminal 29, when it is configured as [Bus Controlled].

5-96 Pulse Out #29 Timeout Preset		
Range:		Function:
0 %*	[0 - 100 %]	Contains the frequency to apply to the digital output terminal 29, when it is configured as [Bus Controlled Timeout] and timeout is detected

5-97 Pulse Out #X30/6 Bus Control		
Range:		Function:
0 %*	[0 - 100 %]	Contains the frequency to apply to the digital output terminal 27, when it is configured as [Bus Controlled].

5-98 Pulse Out #X30/6 Timeout Preset		
Range:		Function:
0 %*	[0 - 100 %]	Contains the frequency to apply to the digital output terminal 6, when it is configured as [Bus Controlled Timeout] and time-out is detected.

3.8 Main Menu - Analog In/Out - Group 6

3.8.1 6-** Analog In/Out

Parameter group for configuration of the analog input and output.

3.8.2 6-0* Analog I/O Mode

Parameter group for setting up the analog I/O configuration.

The frequency converter is equipped with 2 analog inputs: Terminal 53 and 54. The analog inputs can freely be allocated to either voltage (0-10 V) or current input (0/4-20 mA)

NOTE

Thermistors may be connected to either an analog or a digital input.

6-00 Live Zero Timeout Time		
Range:	Function:	
10 s* [1 - 99 s]	Enter the Live Zero Time-out time period. Live Zero Time-out Time is active for analog inputs, i.e. terminal 53 or terminal 54, used as reference or feedback sources. If the reference signal value associated with the selected current input falls below 50% of the value set in 6-10 Terminal 53 Low Voltage, 6-12 Terminal 53 Low Current, 6-20 Terminal 54 Low Voltage or 6-22 Terminal 54 Low Current for a time period longer than the time set in 6-00 Live Zero Timeout Time, the function selected in 6-01 Live Zero Timeout Function will be activated.	

6-01 Live Zero Timeout Function		
Option:	Function:	
	Select the time-out function. The function set in 6-01 Live Zero Timeout Function will be activated if the input signal on terminal 53 or 54 is below 50% of the value in 6-10 Terminal 53 Low Voltage, 6-12 Terminal 53 Low Current, 6-20 Terminal 54 Low Voltage or 6-22 Terminal 54 Low Current for a time period defined in 6-00 Live Zero Timeout Time. If several time-outs occur simultaneously, the frequency converter prioritises the time-out functions as follows	
	<ol style="list-style-type: none"> 6-01 Live Zero Timeout Function 8-04 Control Timeout Function 	
	The output frequency of the frequency converter can be:	

6-01 Live Zero Timeout Function		
Option:	Function:	
	<ul style="list-style-type: none"> [1] frozen at the present value [2] overruled to stop [3] overruled to jog speed [4] overruled to max. speed [5] overruled to stop with subsequent trip 	
[0] *	Off	
[1]	Freeze output	
[2]	Stop	
[3]	Jogging	
[4]	Max. speed	
[5]	Stop and trip	
[21]	Min. Reference	
[22]	Max. Reference	

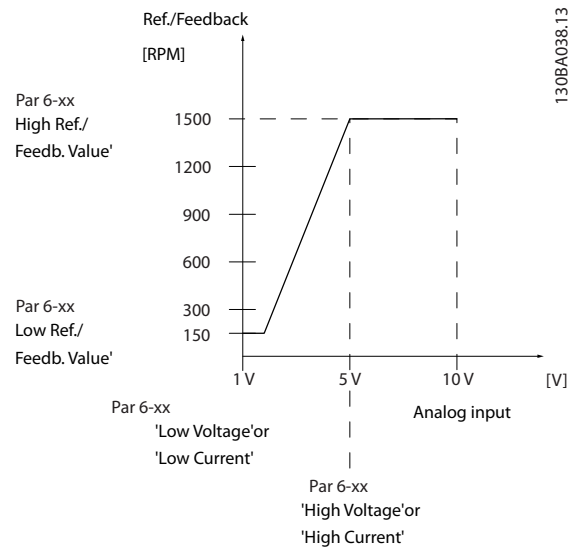

Illustration 3.26

6-02 Fire Mode Live Zero Timeout Function		
Option:	Function:	
	The function set in 6-01 Live Zero Timeout Function will be activated if the input signal on analogue inputs is below 50% of the value defined in parameter groups 6-1* to 6-6* "Terminal xx Low Current" or "Terminal xx Low Voltage" for a time period defined in 6-00 Live Zero Timeout Time.	
[0] *	Off	
[1]	Freeze output	
[2]	Stop	
[3]	Jogging	
[4]	Max. speed	

3.8.3 6-1* Analog Input 1

Parameters for configuring the scaling and limits for analog input 1 (terminal 53).

6-10 Terminal 53 Low Voltage		
Range:	Function:	
0.07 V* [0 - par. 6-11 V]	Enter the low voltage value. This analog input scaling value should correspond to the low reference/feedback value set in <i>6-14 Terminal 53 Low Ref./Feedb. Value</i> .	

6-11 Terminal 53 High Voltage		
Range:	Function:	
10 V* [par. 6-10 - 10 V]	Enter the high voltage value. This analog input scaling value should correspond to the high reference/feedback value set in <i>6-15 Terminal 53 High Ref./Feedb. Value</i> .	

6-12 Terminal 53 Low Current		
Range:	Function:	
4 mA* [0 - par. 6-13 mA]	Enter the low current value. This reference signal should correspond to the low reference/feedback value, set in <i>6-14 Terminal 53 Low Ref./Feedb. Value</i> . The value must be set at >2 mA in order to activate the Live Zero Time-out Function in <i>6-01 Live Zero Timeout Function</i> .	

6-13 Terminal 53 High Current		
Range:	Function:	
20 mA* [par. 6-12 - 20 mA]	Enter the high current value corresponding to the high reference/feedback set in <i>6-15 Terminal 53 High Ref./Feedb. Value</i> .	

6-14 Terminal 53 Low Ref./Feedb. Value		
Range:	Function:	
0 * [-999999.999 - 999999.999]	Enter the analog input scaling value that corresponds to the low voltage/low current set in <i>6-10 Terminal 53 Low Voltage</i> and <i>6-12 Terminal 53 Low Current</i> .	

6-15 Terminal 53 High Ref./Feedb. Value		
Range:	Function:	
Size related* [-999999.999 - 999999.999]	Enter the analog input scaling value that corresponds to the high voltage/high current value set in <i>6-11 Terminal 53 High Voltage</i> and <i>6-13 Terminal 53 High Current</i> .	

6-16 Terminal 53 Filter Time Constant		
Range:	Function:	
0.001 s* [0.001 - 10 s]	Enter the time constant. This is a first-order digital low pass filter time constant for suppressing electrical noise in terminal 53. A high time constant value improves dampening but also increases the time delay through the filter.	

NOTE

This parameter cannot be adjusted while the motor is running.

6-17 Terminal 53 Live Zero		
Option:	Function:	
[0]	Disabled	
[1] *	Enabled	

3.8.4 6-2* Analog Input 2

Parameters for configuring the scaling and limits for analog input 2 (terminal 54).

6-20 Terminal 54 Low Voltage		
Range:	Function:	
0.07 V* [0 - par. 6-21 V]	Enter the low voltage value. This analog input scaling value should correspond to the low reference/feedback value, set in <i>6-24 Terminal 54 Low Ref./Feedb. Value</i> .	

6-21 Terminal 54 High Voltage		
Range:	Function:	
10 V* [par. 6-20 - 10 V]	Enter the high voltage value. This analog input scaling value should correspond to the high reference/feedback value set in <i>6-25 Terminal 54 High Ref./Feedb. Value</i> .	

6-22 Terminal 54 Low Current		
Range:	Function:	
4 mA* [0 - par. 6-23 mA]	Enter the low current value. This reference signal should correspond to the low reference/feedback value, set in <i>6-24 Terminal 54 Low Ref./Feedb. Value</i> . The value must be set at >2 mA to activate the Live Zero Time-out Function in <i>6-01 Live Zero Timeout Function</i> .	

6-23 Terminal 54 High Current		
Range:	Function:	
20 mA* [par. 6-22 - 20 mA]	Enter the high current value corresponding to the high reference/feedback value set in 6-25 Terminal 54 High Ref./Feedb. Value.	

6-24 Terminal 54 Low Ref./Feedb. Value		
Range:	Function:	
-1 * [-999999.999 - 999999.999]	Enter the analog input scaling value that corresponds to the low voltage/low current value set in 6-20 Terminal 54 Low Voltage and 6-22 Terminal 54 Low Current.	

6-25 Terminal 54 High Ref./Feedb. Value		
Range:	Function:	
Size related* [-999999.999 - 999999.999]	Enter the analog input scaling value that corresponds to the high voltage/high current value set in 6-21 Terminal 54 High Voltage and 6-23 Terminal 54 High Current.	

6-26 Terminal 54 Filter Time Constant		
Range:	Function:	
0.001 s* [0.001 - 10 s]	Enter the time constant. This is a first-order digital low pass filter time constant for suppressing electrical noise in terminal 54. A high time constant value improves dampening but also increases the time delay through the filter.	

NOTE

This parameter cannot be adjusted while the motor is running.

6-27 Terminal 54 Live Zero		
Option:	Function:	
	This parameter makes it possible to disable the Live Zero monitoring. E.g. to be used if the analog outputs are used as of a de-central I/O system (e.g. when not as of any frequency converter related control functions, but feeding a Building Management System with data).	
[0]	Disabled	
[1] *	Enabled	

3.8.5 6-3* Analog Input 3 MCB 101

Parameter group for configuring the scale and limits for analog input 3 (X30/11) placed on option module MCB 101.

6-30 Terminal X30/11 Low Voltage		
Range:	Function:	
0.07 V* [0 - par. 6-31 V]	Sets the analog input scaling value to correspond to the low reference/feedback value (set in 6-34 Term. X30/11 Low Ref./Feedb. Value).	

6-31 Terminal X30/11 High Voltage		
Range:	Function:	
10 V* [par. 6-30 - 10 V]	Sets the analog input scaling value to correspond to the high reference/feedback value (set in 6-35 Term. X30/11 High Ref./Feedb. Value).	

6-34 Term. X30/11 Low Ref./Feedb. Value		
Range:	Function:	
0 * [-999999.999 - 999999.999]	Sets the analog input scaling value to correspond to the low voltage value (set in 6-30 Terminal X30/11 Low Voltage).	

6-35 Term. X30/11 High Ref./Feedb. Value		
Range:	Function:	
100 * [-999999.999 - 999999.999]	Sets the analog input scaling value to correspond to the high voltage value (set in 6-31 Terminal X30/11 High Voltage).	

6-36 Term. X30/11 Filter Time Constant		
Range:	Function:	
0.001 s* [0.001 - 10 s]	A 1 st order digital low pass filter time constant for suppressing electrical noise on terminal X30/11.	

NOTE

This parameter cannot be changed while the motor is running.

6-37 Term. X30/11 Live Zero		
Option:	Function:	
	This parameter makes it possible to disable the Live Zero monitoring. E.g. to be used if the analog outputs are used as of a de-central I/O system (e.g. when not of any frequency converter related control functions, but feeding a Building Management System with data).	
[0] *	Disabled	
[1] *	Enabled	

3.8.6 6-4* Analog Input 4 MCB 101

Parameter group for configuring the scale and limits for analog input 4 (X30/12) placed on option module MCB 101.

6-40 Terminal X30/12 Low Voltage		
Range:	Function:	
0.07 V* [0 - par. 6-41 V]	Sets the analog input scaling value to correspond to the low reference/ feedback value set in 6-44 Term. X30/12 Low Ref./Feedb. Value.	

6-41 Terminal X30/12 High Voltage		
Range:	Function:	
10 V* [par. 6-40 - 10 V]	Sets the analog input scaling value to correspond to the high reference/ feedback value set in 6-45 Term. X30/12 High Ref./Feedb. Value.	

6-44 Term. X30/12 Low Ref./Feedb. Value		
Range:	Function:	
0 * [-999999.999 - 999999.999]	Sets the analog output scaling value to correspond to the low voltage value set in 6-40 Terminal X30/12 Low Voltage.	

6-45 Term. X30/12 High Ref./Feedb. Value		
Range:	Function:	
100 * [-999999.999 - 999999.999]	Sets the analog input scaling value to correspond to the high voltage value set in 6-41 Terminal X30/12 High Voltage.	

6-46 Term. X30/12 Filter Time Constant		
Range:	Function:	
0.001 s* [0.001 - 10 s]	A 1 st order digital low pass filter time constant for suppressing electrical noise on terminal X30/12.	

NOTE

This parameter cannot be changed while the motor is running.

6-47 Term. X30/12 Live Zero		
Option:	Function:	
	This parameter makes it possible to disable the Live Zero monitoring. E.g. to be used if the analog outputs are used as of a decentral I/O system (e.g. when not of any frequency converter related control functions, but feeding a Building Management System with data)	
[0] *	Disabled	
[1]	Enabled	

3.8.7 6-5* Analog Output 1

Parameters for configuring the scaling and limits for analog output 1, i.e. Terminal 42. Analog outputs are current outputs: 0/4-20 mA. Common terminal (terminal

39) is the same terminal and has the same electrical potential for analog common and digital common connection. Resolution on analog output is 12 bit.

6-50 Terminal 42 Output		
Option:	Function:	
		Select the function of Terminal 42 as an analog current output. A motor current of 20 mA corresponds to I _{max} .
[0]	No operation	
[100]	Output frequency	0-100 Hz, (0-20 mA)
[101]	Reference	Minimum reference - Maximum reference, (0-20 mA)
[102]	Feedback	-200% to +200% of 20-14 Maximum Reference/Feedb., (0-20 mA)
[103]	Motor Current	0 - Inverter Max. Current (16-37 Inv. Max. Current), (0-20 mA)
[104]	Torque rel to limit	0 - Torque limit (4-16 Torque Limit Motor Mode), (0-20 mA)
[105]	Torq relate to rated	0 - Motor rated torque, (0-20 mA)
[106]	Power	0 - Motor rated power, (0-20 mA)
[107]	Speed	0 - Speed High Limit (4-13 Motor Speed High Limit [RPM] and 4-14 Motor Speed High Limit [Hz]), (0-20 mA)
[108]	Torque	
[109]	Max Out Freq	
[113]	Ext. Closed Loop 1	0-100%, (0-20 mA)
[114]	Ext. Closed Loop 2	0-100%, (0-20 mA)
[115]	Ext. Closed Loop 3	0-100%, (0-20 mA)
[130]	Output freq. 4-20mA	0-100 Hz
[131]	Reference 4-20mA	Minimum Reference - Maximum Reference
[132]	Feedback 4-20mA	-200% to +200% of 20-14 Maximum Reference/Feedb.
[133]	Motor cur. 4-20mA	0 - Inverter Max. Current (16-37 Inv. Max. Current)
[134]	Torq.% lim 4-20 mA	0 - Torque limit (4-16 Torque Limit Motor Mode)
[135]	Torq.% nom 4-20mA	0 - Motor rated torque
[136]	Power 4-20mA	0 - Motor rated power
[137] *	Speed 4-20mA	0 - Speed High Limit (4-13 and 4-14)
[138]	Torque 4-20mA	
[139]	Bus ctrl.	0-100%, (0-20 mA)
[140]	Bus ctrl. 4-20 mA	0-100%

6-50 Terminal 42 Output		
Option:	Function:	
[141]	Bus ctrl t.o.	0-100%, (0-20 mA)
[142]	Bus ctrl t.o. 4-20mA	0-100%
[143]	Ext. CL 1 4-20mA	0-100%
[144]	Ext. CL 2 4-20mA	0-100%
[145]	Ext. CL 3 4-20mA	0-100%
[150]	Max Out Fr 4-20 mA	

NOTE

Values for setting the Minimum Reference is found in open loop 3-02 Minimum Reference and for closed loop 20-13 Minimum Reference/Feedb. - values for maximum reference for open loop is found in 3-03 Maximum Reference and for closed loop 20-14 Maximum Reference/Feedb..

6-51 Terminal 42 Output Min Scale		
Range:	Function:	
0 %* [0 - 200 %]	Scale for the minimum output (0 or 4 mA) of the analog signal at terminal 42. Set the value to be the percentage of the full range of the variable selected in 6-50 Terminal 42 Output.	

6-52 Terminal 42 Output Max Scale		
Range:	Function:	
100 %* [0 - 200 %]	Scale for the maximum output (20mA) of the analog signal at terminal 42. Set the value to be the percentage of the full range of the variable selected in 6-50 Terminal 42 Output.	
	<p>Illustration 3.27</p> <p>It is possible to get a value lower than 20mA at full scale by programming values >100% by using a formula as follows:</p>	

$20 \text{ mA} | \text{desired maximum current} \times 100 \%$
i.e. $10 \text{ mA} : \frac{20 \text{ mA}}{10 \text{ mA}} \times 100 \% = 200 \%$

EXAMPLE 1:

Variable value= OUTPUT FREQUENCY, range = 0-100 Hz
 Range needed for output = 0-50 Hz
 Output signal 0 or 4mA is needed at 0 Hz (0% of range) - set 6-51 Terminal 42 Output Min Scale to 0%
 Output signal 20 mA is needed at 50 Hz (50% of range) - set 6-52 Terminal 42 Output Max Scale to 50%

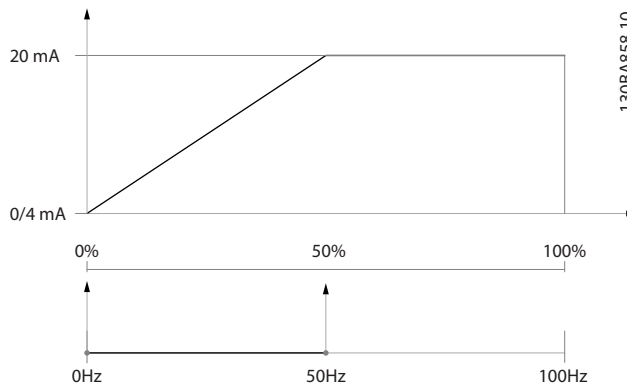

Illustration 3.28

EXAMPLE 2:

Variable= FEEDBACK, range= -200% to +200%
 Range needed for output= 0-100%
 Output signal 0 or 4 mA is needed at 0% (50% of range) - set 6-51 Terminal 42 Output Min Scale to 50%
 Output signal 20 mA is needed at 100% (75% of range) - set 6-52 Terminal 42 Output Max Scale to 75%

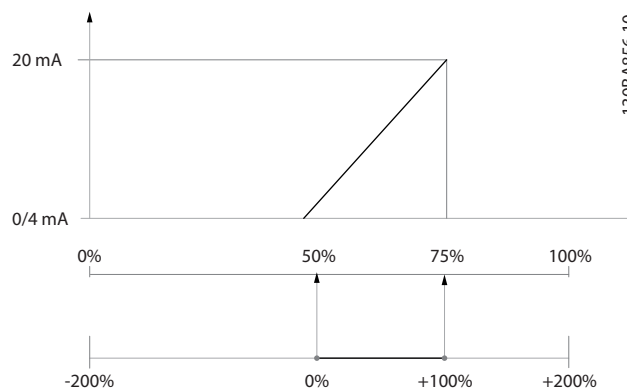

Illustration 3.29

EXAMPLE 3:

Variable value= REFERENCE, range= Min ref - Max ref
 Range needed for output= Min ref (0%) - Max ref (100%), 0-10 mA
 Output signal 0 or 4 mA is needed at Min ref - set 6-51 Terminal 42 Output Min Scale to 0%
 Output signal 10 mA is needed at Max ref (100% of range) - set 6-52 Terminal 42 Output Max Scale to 200% (20 mA/10 mA x 100%=200%).

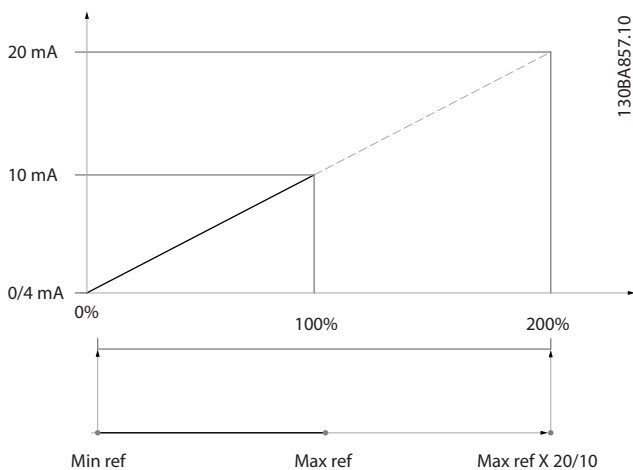

Illustration 3.30

6-62 Terminal X30/8 Max. Scale		
Range:	Function:	
100 %*	[0 - 200 %]	Scales the maximum output of the selected analog signal on terminal X30/8. Scale the value to the desired maximum value of the current signal output. Scale the output to give a lower current than 20 mA at full scale or 20 mA at an output below 100% of the maximum signal value. If 20 mA is the desired output current at a value between 0 - 100% of the full-scale output, program the percentage value in the parameter, i.e. 50% = 20 mA. If a current between 4 and 20 mA is desired at maximum output (100%), calculate the percentage value as follows: $20 \text{ mA} / \text{desired maximum current} \times 100 \%$ <i>i.e. 10 mA : $\frac{20 \text{ mA}}{10 \text{ mA}} \times 100 \% = 200 \%$</i>

6-53 Terminal 42 Output Bus Control		
Range:	Function:	
0 %*	[0 - 100 %]	Holds the level of Output 42 if controlled by bus.

6-63 Terminal X30/8 Output Bus Control		
Range:	Function:	
0 %*	[0 - 100 %]	Contains the value to apply to the output terminal, when it is configured as Bus Controlled.

6-54 Terminal 42 Output Timeout Preset		
Range:	Function:	
0 %*	[0 - 100 %]	Holds the preset level of Output 42. In case of a bus timeout and a timeout function is selected in 6-50 Terminal 42 Output the output will preset to this level.

6-64 Terminal X30/8 Output Timeout Preset		
Range:	Function:	
0 %*	[0 - 100 %]	Contains the value to apply to the output terminal, when it is configured as Bus Controlled Timeout and time-out is detected.

3.8.8 6-6* Analog Output 2 MCB 101

Analog outputs are current outputs: 0/4 - 20 mA. Common terminal (terminal X30/8) is the same terminal and electrical potential for analog common connection. Resolution on analog output is 12 bit.

6-60 Terminal X30/8 Output

Same options and functions as 6-50 Terminal 42 Output.

Option:	Function:	
[0] *	No operation	

6-61 Terminal X30/8 Min. Scale		
Range:	Function:	
0 %*	[0 - 200 %]	Scales the minimum output of the selected analog signal on terminal X30/8. Scale the minimum value as a percentage of the maximum signal value, i.e. 0 mA (or 0 Hz) is desired at 25% of the maximum output value and 25% is programmed. The value can never be higher than the corresponding setting in 6-62 Terminal X30/8 Max. Scale if value is below 100%. This parameter is active when option module MCB 101 is mounted in the frequency converter.

3

3.9 Main Menu - Communications and Options - Group 8

3.9.1 8-** Comm. and Options

3.9.2 8-0* General Settings

8-01 Control Site		
Option:	Function:	
		The setting in this parameter overrides the settings in 8-50 Coasting Select to 8-56 Preset Reference Select.
[0] *	Digital and ctrl.word	Control by using both digital input and control word.
[1]	Digital only	Control by using digital inputs only.
[2]	Controlword only	Control by using control word only.

8-02 Control Source		
Option:	Function:	
		Select the source of the control word: one of two serial interfaces or four installed options. During initial power-up, the frequency converter automatically sets this parameter to [3] Option A if it detects a valid fieldbus option installed in slot A. If the option is removed, the frequency converter detects a change in the configuration, sets 8-02 Control Source back to default setting FC Port, and the frequency converter then trips. If an option is installed after initial power-up, the setting of 8-02 Control Source will not change but the frequency converter will trip and display: Alarm 67 Option Changed.
[0]	None	
[1]	FC Port	
[2]	USB Port	
[3] *	Option A	
[4]	Option B	
[5]	Option C0	
[6]	Option C1	
[30]	External Can	

NOTE

This parameter cannot be adjusted while the motor is running.

8-03 Control Timeout Time		
Range:	Function:	
Size related*	[1 - 18000 s]	Enter the maximum time expected to pass between the reception of two consecutive telegrams. If this time is exceeded, it indicates that the serial communication has stopped. The function selected in

8-03 Control Timeout Time		
Range:	Function:	
		8-04 Control Timeout Function Control Timeout Function will then be carried out. In BACnet the control timeout is only triggered if some specific objects are written. The object list hold information on the objects that triggers the control timeout: Analog Outputs Binary Outputs AV0 AV1 AV2 AV4 BV1 BV2 BV3 BV4 BV5 Multistate Outputs

8-04 Control Timeout Function		
Option:	Function:	
		Select the time-out function. The time-out function is activated when the control word fails to be updated within the time period specified in 8-03 Control Timeout Time. [20] N2 Override Release only appears after setting the Metasys N2 protocol.
[0] *	Off	
[1]	Freeze output	
[2]	Stop	
[3]	Jogging	
[4]	Max. speed	
[5]	Stop and trip	
[7]	Select setup 1	
[8]	Select setup 2	
[9]	Select setup 3	
[10]	Select setup 4	
[20]	N2 Override Release	
[21]	Min. Reference	
[22]	Max. Reference	

8-05 End-of-Timeout Function		
Option:	Function:	
		Select the action after receiving a valid control word following a time-out. This parameter is active only when 8-04 Control Timeout Function is set to [7] Set-up 1, [8] Set-up 2, [9] Set-up 3 or [10] Set-up 4.

8-05 End-of-Timeout Function		
Option:	Function:	
[0]	Hold set-up	Retains the set-up selected in 8-04 Control Timeout Function and displays a warning, until 8-06 Reset Control Timeout toggles. Then the frequency converter resumes its original set-up.
[1] *	Resume set-up	Resumes the set-up active before the time-out.

8-06 Reset Control Timeout		
Option:	Function:	
		This parameter is active only when the choice [0] Hold set-up has been selected in 8-05 End-of-Timeout Function.
[0] *	Do not reset	Retains the set-up specified in 8-04 Control Timeout Function, [7] Set-up 1, [8] Set-up 2, [9] Set-up 3 and [10] Set-up 4 following a control time-out.
[1]	Do reset	Returns the frequency converter to the original set-up following a control word time-out. When the value is set to [1] Do reset, the frequency converter performs the reset and then immediately reverts to the [0] Do not reset setting.

8-07 Diagnosis Trigger		
Option:	Function:	
		This parameter has no function for BACnet.
[0] *	Disable	
[1]	Trigger on alarms	
[2]	Trigger alarm/warn.	

3.9.3 8-1* Ctrl. Word Settings

8-10 Control Profile		
Option:	Function:	
		Select the interpretation of the control and status words corresponding to the installed fieldbus. Only the selections valid for the fieldbus installed in slot A will be visible in the LPC display.
[0] *	FC profile	
[1]	PROFIdrive profile	
[5]	ODVA	
[7]	CANopen DSP 402	

8-13 Configurable Status Word STW		
Option:	Function:	
		This parameter enables configuration of bits 12–15 in the status word.
[0]	No function	

8-13 Configurable Status Word STW		
Option:	Function:	
[1] *	Profile Default	Function corresponds to the profile default selected in 8-10 Control Profile.
[2]	Alarm 68 Only	Only set in case of an Alarm 68.
[3]	Trip excl. Alarm 68	Set in case of a trip, except if Alarm 68 executes the trip.
[10]	T18 DI status.	The bit indicates the status of terminal 18. "0" indicates that the terminal is low "1" indicates that the terminal is high
[11]	T19 DI status.	The bit indicates the status of terminal 19. "0" indicates that the terminal is low "1" indicates that the terminal is high
[12]	T27 DI status.	The bit indicates the status of terminal 27. "0" indicates that the terminal is low "1" indicates that the terminal is high
[13]	T29 DI status.	The bit indicates the status of terminal 29. "0" indicates that the terminal is low "1" indicates that the terminal is high
[14]	T32 DI status.	The bit indicates the status of terminal 32. "0" indicates that the terminal is low "1" indicates that the terminal is high
[15]	T33 DI status.	The bit indicates the status of terminal 33. "0" indicates that the terminal is low "1" indicates that the terminal is high
[16]	T37 DI status	The bit indicates the status of terminal 37. 0" indicates T37 is low (safe stop) "1" indicates T37 is high (normal)
[21]	Thermal warning	The thermal warning turns on when the temperature exceeds the limit in the motor, the frequency converter, the brake resistor, or the thermistor.
[30]	Brake fault (IGBT)	Output is Logic '1' when the brake IGBT is short-circuited. Use this function to protect the frequency converter if there is a fault on the brake modules. Use the output/relay to cut out the main voltage from the frequency converter.
[40]	Out of ref. range	
[60]	Comtor 0	See parameter group 13-1*. If Comtor 0 is evaluated as TRUE, the output goes high. Otherwise, it is low.
[61]	Comtor 1	See parameter group 13-1*. If Comtor 1 is evaluated as TRUE, the output goes high. Otherwise, it is low.
[62]	Comtor 2	See parameter group 13-1*. If Comtor 2 is evaluated as TRUE, the output goes high. Otherwise, it is low.
[63]	Comtor 3	See parameter group 13-1*. If Comtor 3 is evaluated as TRUE, the output goes high. Otherwise, it is low.
[64]	Comtor 4	See parameter group 13-1*. If Comtor 4 is evaluated as TRUE, the output goes high. Otherwise, it is low.

8-13 Configurable Status Word STW
Option: Function:

[65]	Comtor 5	See parameter group 13-1*. If Comtor 5 is evaluated as TRUE, the output goes high. Otherwise, it is low.
[70]	Logic Rule 0	See parameter group 13-4*. If Logic Rule 0 is evaluated as TRUE, the output goes high. Otherwise, it is low.
[71]	Logic Rule 1	See parameter group 13-4*. If Logic Rule 1 is evaluated as TRUE, the output goes high. Otherwise, it is low.
[72]	Logic Rule 2	See parameter group 13-4*. If Logic Rule 2 is evaluated as TRUE, the output goes high. Otherwise, it is low.
[73]	Logic Rule 3	See parameter group 13-4*. If Logic Rule 3 is evaluated as TRUE, the output goes high. Otherwise, it is low.
[74]	Logic Rule 4	See parameter group 13-4*. If Logic Rule 4 is evaluated as TRUE, the output goes high. Otherwise, it is low.
[75]	Logic Rule 5	See parameter group 13-4*. If Logic Rule 5 is evaluated as TRUE, the output goes high. Otherwise, it is low.
[80]	SL Digital Output A	See 13-52 <i>SL Controller Action</i> . The output goes high whenever the Smart Logic Action [38] <i>Set digital out A high</i> is executed. The output goes low whenever the Smart Logic Action [32] <i>Set digital out A low</i> is executed.
[81]	SL Digital Output B	See 13-52 <i>SL Controller Action</i> . The input goes high whenever the Smart Logic Action [39] <i>Set digital out B high</i> is executed. The input goes low whenever the Smart Logic Action [33] <i>Set digital out B low</i> is executed.
[82]	SL Digital Output C	See 13-52 <i>SL Controller Action</i> . The input goes high whenever the Smart Logic Action [40] <i>Set digital out C high</i> is executed. The input goes low whenever the Smart Logic Action [34] <i>Set digital out C low</i> is executed.
[83]	SL Digital Output D	See 13-52 <i>SL Controller Action</i> . The input goes high whenever the Smart Logic Action [41] <i>Set digital out D high</i> is executed. The input goes low whenever the Smart Logic Action [35] <i>Set digital out D low</i> is executed.
[84]	SL Digital Output E	See 13-52 <i>SL Controller Action</i> . The input goes high whenever the Smart Logic Action [42] <i>Set digital out E high</i> is executed. The input goes low whenever the Smart Logic Action [36] <i>Set digital out E low</i> is executed.
[85]	SL Digital Output F	See 13-52 <i>SL Controller Action</i> . The input goes high whenever the Smart Logic Action [43] <i>Set digital out F high</i> is executed. The input goes low whenever the Smart Logic Action [37] <i>Set digital out F low</i> is executed.

3.9.4 8-3* FC Port Settings
8-30 Protocol

Protocol selection for the integrated FC (standard) Port (RS-485) on the control card.

Parameter group 8-7* is only visible when FC Option [9] is chosen.

Option: Function:

[0] *	FC	Communication according to the FC Protocol as described in the <i>VLT Refrigeration Drive FC 103 Design Guide, chapter: RS-485 Installation and Set-up</i> .
[1]	FC MC	Same as FC [0] but to be used when downloading SW to the frequency converter or uploading dll file (covering information regarding parameters available in the frequency converter and their inter-dependencies) to Motion Control Tool MCT10.
[2]	Modbus RTU	Communication according to the Modbus RTU protocol as described in the <i>VLT Refrigeration Drive FC 103 Design Guide, chapter: RS-485 Installation and Set-up</i> .
[3]	Metasys N2	Communication protocol. The N2 software protocol is designed to be general in nature in order to accommodate the unique properties each device may have. Please see set manual <i>VLT® HVAC Drive Metasys, MG11Gxyy</i> .
[9]	FC option	To be used when a gateway is connected to the integrated RS-485 port, e.g. the BACnet gateway. Following changes will take place: -Address for the FC port will be set to 1 and 8-31 <i>Address</i> is now used to set the address for the gateway on the network, e.g. BACnet. Please see set manual <i>VLT® HVAC Drive BACnet, MG11DXYY</i> . -Baud rate for the FC port will be set to a fixed value (115.200 Baud) and 8-32 <i>Baud Rate</i> , is now used to set the baud rate for the network port (e.g. BACnet) on the gateway.

NOTE

Further details can be found in the **BACnet and Metasys manuals**.

8-31 Address

Range:		Function:
Size related*	[1 - 126]	Enter the address for the FC (standard) port. Valid range: 1-126.

8-32 Baud Rate		
Option:	Function:	
		Baud rates 9600, 19200, 38400 and 76800 baud are valid for BACnet only.
[0]	2400 Baud	
[1]	4800 Baud	
[2] *	9600 Baud	
[3]	19200 Baud	
[4]	38400 Baud	
[5]	57600 Baud	
[6]	76800 Baud	
[7]	115200 Baud	

Default refers to the FC Protocol.

8-33 Parity / Stop Bits		
Option:	Function:	
		Parity and Stop Bits for the protocol 8-30 Protocol using the FC Port. For some of the protocols, not all options are visible. Default depends on the protocol selected.
[0] *	Even Parity, 1 Stop Bit	
[1]	Odd Parity, 1 Stop Bit	
[2]	No Parity, 1 Stop Bit	
[3]	No Parity, 2 Stop Bits	

8-35 Minimum Response Delay		
Range:	Function:	
Size related*	[5 - 10000 ms]	Specify the minimum delay time between receiving a request and transmitting a response. This is used for overcoming modem turnaround delays.

8-36 Maximum Response Delay		
Range:	Function:	
Size related*	[11 - 10001 ms]	Specify the maximum permissible delay time between transmitting a request and receiving a response. Exceeding this delay time will cause control word time-out.

8-37 Maximum Inter-Char Delay		
Range:	Function:	
Size related*	[0.00 - 35.00 ms]	Specify the maximum permissible time interval between receipt of two bytes. This parameter activates time-out if transmission is interrupted.

3.9.5 8-4* Telegram Selection

8-40 Telegram Selection		
Option:	Function:	
		Enables use of freely configurable telegrams or standard telegrams for the FC port.
[1] *	Standard telegram 1	
[101]	PPO 1	
[102]	PPO 2	
[103]	PPO 3	
[104]	PPO 4	
[105]	PPO 5	
[106]	PPO 6	
[107]	PPO 7	
[108]	PPO 8	
[200]	Custom telegram 1	

8-45 BTM Transaction Command		
Option:	Function:	
[0]	Off	

8-46 BTM Transaction Status		
Option:	Function:	
[0]	Off	
[1]	Transaction Started	
[2]	Transaction Comitting	
[3]	Transaction Timeout	
[4]	Err. Non-existing Par.	
[5]	Err. Par. Out of Range	

8-47 BTM Timeout		
Range:	Function:	
60 s*	[0 - 360 s]	

3.9.6 8-5* Digital/Bus

Parameters for configuring the control word Digital/Bus merging.

NOTE

These parameters are active only when 8-01 Control Site is set to [0] Digital and control word.

8-50 Coasting Select		
Option:	Function:	
		Select control of the coasting function via the terminals (digital input) and/or via the bus.
[0]	Digital input	Activates Start command via a digital input.
[1]	Bus	Activates Start command via the serial communication port or fieldbus option.

8-50 Coasting Select		
Option:	Function:	
[2]	Logic AND	Activates Start command via the fieldbus/serial communication port, AND additionally via one of the digital inputs.
[3] *	Logic OR	Activates Start command via the fieldbus/serial communication port OR via one of the digital inputs.

8-52 DC Brake Select		
Option:	Function:	
		Select control of the DC brake via the terminals (digital input) and/or via the fieldbus. NOTE Only selection [0] Digital input is available when 1-10 Motor Construction is set to [1] PM non-salient SPM.
[0]	Digital input	Activates Start command via a digital input.
[1]	Bus	Activates Start command via the serial communication port or fieldbus option.
[2]	Logic AND	Activates Start command via the fieldbus/serial communication port, AND additionally via one of the digital inputs.
[3] *	Logic OR	Activates Start command via the fieldbus/serial communication port OR via one of the digital inputs.

8-53 Start Select		
Option:	Function:	
		Select control of the frequency converter start function via the terminals (digital input) and/or via the fieldbus.
[0]	Digital input	Activates Start command via a digital input.
[1]	Bus	Activates Start command via the serial communication port or fieldbus option.
[2]	Logic AND	Activates Start command via the fieldbus/serial communication port, AND additionally via one of the digital inputs.
[3] *	Logic OR	Activates Start command via the fieldbus/serial communication port OR via one of the digital inputs.

8-54 Reversing Select		
Option:	Function:	
		Select control of the frequency converter reverse function via the terminals (digital input) and/or via the fieldbus.
[0] *	Digital input	Activates Reverse command via a digital input.

8-54 Reversing Select		
Option:	Function:	
[1]	Bus	Activates Reverse command via the serial communication port or fieldbus option.
[2]	Logic AND	Activates Reverse command via the fieldbus/serial communication port, AND additionally via one of the digital inputs.
[3]	Logic OR	Activates Reverse command via the fieldbus/serial communication port OR via one of the digital inputs.

NOTE

This parameter is active only when 8-01 Control Site is set to [0] Digital and control word.

8-55 Set-up Select		
Option:	Function:	
		Select control of the frequency converter set-up selection via the terminals (digital input) and/or via the fieldbus.
[0]	Digital input	Activates the set-up selection via a digital input.
[1]	Bus	Activates the set-up selection via the serial communication port or fieldbus option.
[2]	Logic AND	Activates the set-up selection via the fieldbus/serial communication port, AND additionally via one of the digital inputs.
[3] *	Logic OR	Activate the set-up selection via the fieldbus/serial communication port OR via one of the digital inputs.

8-56 Preset Reference Select		
Option:	Function:	
		Select control of the frequency converter Preset Reference selection via the terminals (digital input) and/or via the fieldbus.
[0]	Digital input	Activates Preset Reference selection via a digital input.
[1]	Bus	Activates Preset Reference selection via the serial communication port or fieldbus option.
[2]	Logic AND	Activates Preset Reference selection via the fieldbus/serial communication port, AND additionally via one of the digital inputs.
[3] *	Logic OR	Activates the Preset Reference selection via the fieldbus/serial communication port OR via one of the digital inputs.

3.9.7 8-8* FC Port Diagnostics

These parameters are used for monitoring the Bus communication via the FC Port.

8-80 Bus Message Count		
Range:	Function:	
0 *	[0 - 0]	This parameter shows the number of valid telegrams detected on the bus.

8-81 Bus Error Count		
Range:	Function:	
0 *	[0 - 0]	This parameter shows the number of telegrams with faults (e.g. CRC fault), detected on the bus.

8-82 Slave Message Count		
Range:	Function:	
0 *	[0 - 0]	This parameter shows the number of valid telegrams addressed to the slave, sent by the frequency converter.

8-83 Slave Error Count		
Range:	Function:	
0 *	[0 - 0]	This parameter shows the number of error telegrams, which could not be executed by the frequency converter.

Range:	Function:	
0 *	[0 - 0]	This parameter shows the number of messages sent from this frequency converter.

Range:	Function:	
0 *	[0 - 0]	This parameter shows the number of messages suppressed due to time-out.

3.9.8 8-9* Bus Jog

8-90 Bus Jog 1 Speed		
Range:	Function:	
100 RPM*	[0 - par. 4-13 RPM]	Enter the jog speed. Activate this fixed jog speed via the serial port or fieldbus option.

8-91 Bus Jog 2 Speed		
Range:	Function:	
Size related*	[0 - par. 4-13 RPM]	Enter the jog speed. Activate this fixed jog speed via the serial port or fieldbus option.

8-94 Bus Feedback 1		
Range:	Function:	
0 *	[-200 - 200]	Write a feedback to this parameter via the serial communication port or fieldbus option. This parameter must be selected in <i>20-00 Feedback 1 Source</i> , <i>20-03 Feedback 2 Source</i> or <i>20-06 Feedback 3 Source</i> as a feedback source.

8-95 Bus Feedback 2		
Range:	Function:	
0 *	[-200 - 200]	See <i>8-94 Bus Feedback 1</i> for further details.

8-96 Bus Feedback 3		
Range:	Function:	
0 *	[-200 - 200]	See <i>8-94 Bus Feedback 1</i> for further details.

3.10 Main Menu - Smart Logic - Group 13

3.10.1 13-** Prog. Features

Smart Logic Control (SLC) is essentially a sequence of user defined actions (see 13-52 *SL Controller Action* [x]) executed by the SLC when the associated user defined event (see 13-51 *SL Controller Event* [x]) is evaluated as TRUE by the SLC. Events and actions are each numbered and linked together in pairs. This means that when [0] event is fulfilled (attains the value TRUE), [0] action is executed. After this, the conditions of [1] event will be evaluated and if evaluated TRUE, [1] action will be executed and so on. Only one event will be evaluated at any time. If an event is evaluated as FALSE, nothing happens (in the SLC) during the current scan interval and no other events will be evaluated. This means that when the SLC starts, it evaluates [0] event (and only [0] event) each scan interval. Only when [0] event is evaluated TRUE, will the SLC execute [0] action and start evaluating [1] event. It is possible to programme from 1 to 20 events and actions. When the last event/action has been executed, the sequence starts over again from [0] event/[0] action. The illustration shows an example with three event/actions

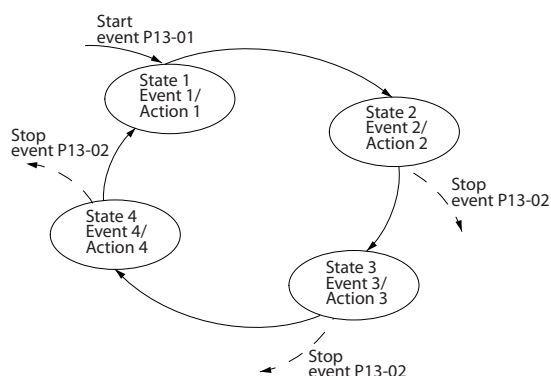

130BA062.13

Illustration 3.31

Starting and stopping the SLC:

Starting and stopping the SLC can be done by selecting [1] On or [0] Off in 13-00 *SL Controller Mode*. The SLC always starts in state 0 (where it evaluates [0] event). The SLC starts when the Start Event (defined in 13-01 *Start Event*) is evaluated as TRUE (provided that [1] On is selected in 13-00 *SL Controller Mode*). The SLC stops when the Stop Event (13-02 *Stop Event*) is TRUE. 13-03 *Reset SLC* resets all SLC parameters and starts programming from scratch.

3.10.2 13-0* SLC Settings

Use the SLC settings to activate, deactivate and reset the Smart Logic Control sequence. The logic functions and comtors are always running in the background, which opens for sete control of digital inputs and outputs.

13-00 SL Controller Mode		
Option:	Function:	
[0]	Off	Disables the Smart Logic Controller.
[1]	On	Enables the Smart Logic Controller.

13-01 Start Event		
Option:	Function:	
		Select the boolean (TRUE or FALSE) input to activate Smart Logic Control.
[0] *	False	Enters the fixed value of FALSE in the logic rule.
[1]	True	Enters the fixed value TRUE in the logic rule.
[2]	Running	See parameter group 5-3* for further description.
[3]	In range	See parameter group 5-3* for further description.
[4]	On reference	See parameter group 5-3* for further description.
[5]	Torque limit	See parameter group 5-3* for further description.
[6]	Current Limit	See parameter group 5-3* for further description.
[7]	Out of current range	See parameter group 5-3* for further description.
[8]	Below I low	See parameter group 5-3* for further description.
[9]	Above I high	See parameter group 5-3* for further description.
[10]	Out of speed range	
[11]	Below speed low	See parameter group 5-3* for further description.
[12]	Above speed high	See parameter group 5-3* for further description.
[13]	Out of feedb. range	
[14]	Below feedb. low	
[15]	Above feedb. high	
[16]	Thermal warning	See parameter group 5-3* for further description.
[17]	Mains out of range	See parameter group 5-3* for further description.
[18]	Reversing	See parameter group 5-3* for further description.
[19]	Warning	See parameter group 5-3* for further description.
[20]	Alarm (trip)	See parameter group 5-3* for further description.

13-01 Start Event		
Option:		Function:
[21]	Alarm (trip lock)	See parameter group 5-3* for further description.
[22]	Comparator 0	Use the result of comtor 0 in the logic rule.
[23]	Comparator 1	Use the result of comtor 1 in the logic rule.
[24]	Comparator 2	Use the result of comtor 2 in the logic rule.
[25]	Comparator 3	Use the result of comtor 3 in the logic rule.
[26]	Logic rule 0	Use the result of logic rule 0 in the logic rule.
[27]	Logic rule 1	Use the result of logic rule 1 in the logic rule.
[28]	Logic rule 2	Use the result of logic rule 2 in the logic rule.
[29]	Logic rule 3	Use the result of logic rule 3 in the logic rule.
[33]	Digital input DI18	Use the value of DI18 in the logic rule (High = TRUE).
[34]	Digital input DI19	Use the value of DI19 in the logic rule (High = TRUE).
[35]	Digital input DI27	Use the value of DI27 in the logic rule (High = TRUE).
[36]	Digital input DI29	Use the value of DI29 in the logic rule (High = TRUE).
[37]	Digital input DI32	Use the value of DI32 in the logic rule (High = TRUE).
[38]	Digital input DI33	Use the value of DI33 in the logic rule (High = TRUE).
[39]	Start command	This event is TRUE if the frequency converter is started by any means (either via digital input, field bus or other).
[40]	Drive stopped	This event is TRUE if the frequency converter is stopped or coasted by any means (either via digital input, fieldbus or other).
[41]	Reset Trip	This event is TRUE if the frequency converter is tripped (but not trip-locked) and [Reset] is pressed.
[42]	Auto Reset Trip	This event is TRUE if the frequency converter is tripped (but not trip-locked) and an Automatic Reset is issued.
[43]	OK Key	This event is TRUE if [OK] is pressed.
[44]	Reset Key	This event is TRUE if [Reset] is pressed.

13-01 Start Event		
Option:		Function:
[45]	Left Key	This event is TRUE if [◀] is pressed.
[46]	Right Key	This event is TRUE if [▶] is pressed.
[47]	Up Key	This event is TRUE if [▲] is pressed.
[48]	Down Key	This event is TRUE if [▼] is pressed.
[50]	Comparator 4	Use the result of comtor 4 in the logic rule.
[51]	Comparator 5	Use the result of comtor 5 in the logic rule.
[60]	Logic rule 4	Use the result of logic rule 4 in the logic rule.
[61]	Logic rule 5	Use the result of logic rule 5 in the logic rule.

13-02 Stop Event		
Option:		Function:
		Select the boolean (TRUE or FALSE) input to deactivate Smart Logic Control.
[0] *	False	Enters the fixed value of FALSE in the logic rule.
[1]	True	Enters the fixed value TRUE in the logic rule.
[2]	Running	See parameter group 5-3* for further description.
[3]	In range	See parameter group 5-3* for further description.
[4]	On reference	See parameter group 5-3* for further description.
[5]	Torque limit	See parameter group 5-3* for further description.
[6]	Current Limit	See parameter group 5-3* for further description.
[7]	Out of current range	See parameter group 5-3* for further description.
[8]	Below I low	See parameter group 5-3* for further description.
[9]	Above I high	See parameter group 5-3* for further description.
[10]	Out of speed range	
[11]	Below speed low	See parameter group 5-3* for further description.
[12]	Above speed high	See parameter group 5-3* for further description.
[13]	Out of feedb. range	See parameter group 5-3* for further description.

13-02 Stop Event		
Option:	Function:	
[14]	Below feedb. low	See parameter group 5-3* for further description.
[15]	Above feedb. high	See parameter group 5-3* for further description.
[16]	Thermal warning	See parameter group 5-3* for further description.
[17]	Mains out of range	See parameter group 5-3* for further description.
[18]	Reversing	See parameter group 5-3* for further description.
[19]	Warning	See parameter group 5-3* for further description.
[20]	Alarm (trip)	See parameter group 5-3* for further description.
[21]	Alarm (trip lock)	See parameter group 5-3* for further description.
[22]	Comparator 0	Use the result of comtor 0 in the logic rule.
[23]	Comparator 1	Use the result of comtor 1 in the logic rule.
[24]	Comparator 2	Use the result of comtor 2 in the logic rule.
[25]	Comparator 3	Use the result of comtor 3 in the logic rule.
[26]	Logic rule 0	Use the result of logic rule 0 in the logic rule.
[27]	Logic rule 1	Use the result of logic rule 1 in the logic rule.
[28]	Logic rule 2	Use the result of logic rule 2 in the logic rule.
[29]	Logic rule 3	Use the result of logic rule 3 in the logic rule.
[30]	SL Time-out 0	Use the result of timer 0 in the logic rule.
[31]	SL Time-out 1	Use the result of timer 1 in the logic rule.
[32]	SL Time-out 2	Use the result of timer 2 in the logic rule.
[33]	Digital input DI18	Use the value of DI18 in the logic rule (High = TRUE).
[34]	Digital input DI19	Use the value of DI19 in the logic rule (High = TRUE).
[35]	Digital input DI27	Use the value of DI27 in the logic rule (High = TRUE).
[36]	Digital input DI29	Use the value of DI29 in the logic rule (High = TRUE).

13-02 Stop Event		
Option:	Function:	
[37]	Digital input DI32	Use the value of DI32 in the logic rule (High = TRUE).
[38]	Digital input DI33	Use the value of DI33 in the logic rule (High = TRUE).
[39]	Start command	This event is TRUE if the frequency converter is started by any means (either via digital input, fieldbus or other).
[40]	Drive stopped	This event is TRUE if the frequency converter is stopped or coasted by any means (either via digital input, fieldbus or other).
[41]	Reset Trip	This event is TRUE if the frequency converter is tripped (but not trip-locked) and [Reset] is pressed.
[42]	Auto Reset Trip	This event is TRUE if the frequency converter is tripped (but not trip-locked) and an Automatic Reset is issued.
[43]	OK Key	This event is TRUE if [OK] is pressed.
[44]	Reset Key	This event is TRUE if [Reset] is pressed.
[45]	Left Key	This event is TRUE if [◀] is pressed.
[46]	Right Key	This event is TRUE if [▶] is pressed.
[47]	Up Key	This event is TRUE if [▲] is pressed.
[48]	Down Key	This event is TRUE if [▼] is pressed.
[50]	Comparator 4	Use the result of comtor 4 in the logic rule.
[51]	Comparator 5	Use the result of comtor 5 in the logic rule.
[60]	Logic rule 4	Use the result of logic rule 4 in the logic rule.
[61]	Logic rule 5	Use the result of logic rule 5 in the logic rule.
[70]	SL Time-out 3	Use the result of timer 3 in the logic rule.
[71]	SL Time-out 4	Use the result of timer 4 in the logic rule.
[72]	SL Time-out 5	Use the result of timer 5 in the logic rule.
[73]	SL Time-out 6	Use the result of timer 6 in the logic rule.
[74]	SL Time-out 7	Use the result of timer 7 in the logic rule.
[80]	No Flow	
[81]	Dry Pump	
[82]	End of Curve	

13-02 Stop Event		
Option:	Function:	
[83]	Broken Belt	

13-03 Reset SLC		
Option:	Function:	
[0] *	Do not reset SLC	Retains programmed settings in all parameter group 13 parameters (13-**).
[1]	Reset SLC	Resets all parameter group 13 parameters (13-**) to default settings.

3.10.3 13-1* Comtors

13-10 Comparator Operand		
Array [5]		
Option:	Function:	
		Select the variable to be monitored by the comtor.
[0] *	DISABLED	
[1]	Reference	
[2]	Feedback	
[3]	Motor speed	
[4]	Motor Current	
[5]	Motor torque	
[6]	Motor power	
[7]	Motor voltage	
[8]	DC-link voltage	
[9]	Motor Thermal	
[10]	Drive thermal	
[11]	Heat sink temp.	
[12]	Analog input AI53	
[13]	Analog input AI54	
[14]	Analog input AIFB10	
[15]	Analog input AIS24V	
[17]	Analog input AICCT	
[18]	Pulse input FI29	
[19]	Pulse input FI33	
[20]	Alarm number	
[30]	Counter A	
[31]	Counter B	

13-11 Comparator Operator		
Array [6]		
Option:	Function:	
[0] *	<	Select [0] < for the result of the evaluation to be TRUE, when the variable selected in 13-10 Comparator Operand is smaller than the fixed value in 13-12 Comparator Value. The result will be FALSE, if the variable selected in 13-10 Comparator Operand is greater than the fixed value in 13-12 Comparator Value.

13-11 Comparator Operator		
Array [6]		
Option:	Function:	
[1]	≈ (equal)	Select [1] ≈ for the result of the evaluation to be TRUE, when the variable selected in 13-10 Comparator Operand is approximately equal to the fixed value in 13-12 Comparator Value.
[2]	>	Select [2] > for the inverse logic of option [0] <.

13-12 Comparator Value		
Array [6]		
Range:	Function:	
Size related*	[-100000 - 100000]	Enter the 'trigger level' for the variable that is monitored by this comtor. This is an array parameter containing comtor values 0 to 5.

3.10.4 13-2* Timers

Use the result (TRUE or FALSE) from *timers* directly to define an *event* (see 13-51 *SL Controller Event*), or as boolean input in a *logic rule* (see 13-40 *Logic Rule Boolean 1*, 13-42 *Logic Rule Boolean 2* or 13-44 *Logic Rule Boolean 3*). A timer is only FALSE when started by an action (i.e. [29] *Start timer 1*) until the timer value entered in this parameter is elapsed. Then it becomes TRUE again. All parameters in this parameter group are array parameters with index 0 to 2. Select index 0 to program Timer 0, select index 1 to program Timer 1, and so on.

13-20 SL Controller Timer		
Array [8]		
Range:	Function:	
Size related*	[0 - 0]	Enter the value to define the duration of the FALSE output from the programmed timer. A timer is only FALSE if it is started by an action (i.e. [29]vStart timer 1) and until the given timer value has elapsed.

3.10.5 13-4* Logic Rules

Combine up to three boolean inputs (TRUE/FALSE inputs) from timers, comtors, digital inputs, status bits and events using the logical operators AND, OR, and NOT. Select boolean inputs for the calculation in 13-40 *Logic Rule Boolean 1*, 13-42 *Logic Rule Boolean 2* and 13-44 *Logic Rule Boolean 3*. Define the operators used to logically combine the selected inputs in 13-41 *Logic Rule Operator 1* and 13-43 *Logic Rule Operator 2*.

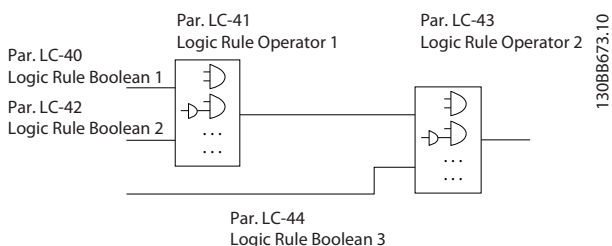

Illustration 3.32

Priority of calculation

The results of 13-40 Logic Rule Boolean 1, 13-41 Logic Rule Operator 1 and 13-42 Logic Rule Boolean 2 are calculated first. The outcome (TRUE/FALSE) of this calculation is combined with the settings of 13-43 Logic Rule Operator 2 and 13-44 Logic Rule Boolean 3, yielding the final result (TRUE/FALSE) of the logic rule.

13-40 Logic Rule Boolean 1		
Array [6]		
Option:	Function:	
[0] * False	Enters the fixed value of FALSE in the logic rule.	
[1] True	Enters the fixed value TRUE in the logic rule.	
[2] Running	See parameter group 5-3* for further description.	
[3] In range	See parameter group 5-3* for further description.	
[4] On reference	See parameter group 5-3* for further description.	
[5] Torque limit	See parameter group 5-3* for further description.	
[6] Current Limit	See parameter group 5-3* for further description.	
[7] Out of current range	See parameter group 5-3* for further description.	
[8] Below I low	See parameter group 5-3* for further description.	
[9] Above I high	See parameter group 5-3* for further description.	
[10] Out of speed range		
[11] Below speed low	See parameter group 5-3* for further description.	
[12] Above speed high	See parameter group 5-3* for further description.	
[13] Out of feedb. range	See parameter group 5-3* for further description.	
[14] Below feedb. low	See parameter group 5-3* for further description.	

13-40 Logic Rule Boolean 1		
Array [6]		
Option:	Function:	
[15] Above feedb. high	See parameter group 5-3* for further description.	
[16] Thermal warning	See parameter group 5-3* for further description.	
[17] Mains out of range	See parameter group 5-3* for further description.	
[18] Reversing	See parameter group 5-3* for further description.	
[19] Warning	See parameter group 5-3* for further description.	
[20] Alarm (trip)	See parameter group 5-3* for further description.	
[21] Alarm (trip lock)	See parameter group 5-3* for further description.	
[22] Comparator 0	Use the result of comtor 0 in the logic rule.	
[23] Comparator 1	Use the result of comtor 1 in the logic rule.	
[24] Comparator 2	Use the result of comtor 2 in the logic rule.	
[25] Comparator 3	Use the result of comtor 3 in the logic rule.	
[26] Logic rule 0	Use the result of logic rule 0 in the logic rule.	
[27] Logic rule 1	Use the result of logic rule 1 in the logic rule.	
[28] Logic rule 2	Use the result of logic rule 2 in the logic rule.	
[29] Logic rule 3	Use the result of logic rule 3 in the logic rule.	
[30] SL Time-out 0	Use the result of timer 0 in the logic rule.	
[31] SL Time-out 1	Use the result of timer 1 in the logic rule.	
[32] SL Time-out 2	Use the result of timer 2 in the logic rule.	
[33] Digital input DI18	Use the value of DI18 in the logic rule (High = TRUE).	
[34] Digital input DI19	Use the value of DI19 in the logic rule (High = TRUE).	
[35] Digital input DI27	Use the value of DI27 in the logic rule (High = TRUE).	
[36] Digital input DI29	Use the value of DI29 in the logic rule (High = TRUE).	

13-40 Logic Rule Boolean 1		
Array [6]		
Option:	Function:	
[37]	Digital input DI32	Use the value of DI32 in the logic rule (High = TRUE).
[38]	Digital input DI33	Use the value of DI33 in the logic rule (High = TRUE).
[39]	Start command	This logic rule is TRUE if the frequency converter is started by any means (either via digital input, field bus or other).
[40]	Drive stopped	This logic rule is TRUE if the frequency converter is stopped or coasted by any means (either via digital input, fieldbus or other).
[41]	Reset Trip	This logic rule is TRUE if the frequency converter is tripped (but not trip-locked) and [Reset] is pressed.
[42]	Auto Reset Trip	This logic rule is TRUE if the frequency converter is tripped (but not trip-locked) and an Automatic Reset is issued.
[43]	OK Key	This logic rule is TRUE if the OK key on the LCP is pressed.
[44]	Reset Key	This logic rule is TRUE if the Reset key on the LCP is pressed.
[45]	Left Key	This logic rule is TRUE if the Left key on the LCP is pressed.
[46]	Right Key	This logic rule is TRUE if the Right key on the LCP is pressed.
[47]	Up Key	This logic rule is TRUE if the Up key on the LCP is pressed.
[48]	Down Key	This logic rule is TRUE if the Down key on the LCP is pressed.
[50]	Comparator 4	Use the result of comtor 4 in the logic rule.
[51]	Comparator 5	Use the result of comtor 5 in the logic rule.
[60]	Logic rule 4	Use the result of logic rule 4 in the logic rule.
[61]	Logic rule 5	Use the result of logic rule 5 in the logic rule.
[70]	SL Time-out 3	Use the result of timer 3 in the logic rule.
[71]	SL Time-out 4	Use the result of timer 4 in the logic rule.
[72]	SL Time-out 5	Use the result of timer 5 in the logic rule.

13-40 Logic Rule Boolean 1		
Array [6]		
Option:	Function:	
[73]	SL Time-out 6	Use the result of timer 6 in the logic rule.
[74]	SL Time-out 7	Use the result of timer 7 in the logic rule.
[80]	No Flow	
[81]	Dry Pump	
[82]	End of Curve	
[83]	Broken Belt	

13-41 Logic Rule Operator 1		
Array [6]		
Option:	Function:	
		Select the first logical operator to use on the Boolean inputs from <i>13-40 Logic Rule Boolean 1</i> and <i>13-42 Logic Rule Boolean 2</i> . [13-**] signifies the boolean input of parameter group 13-**.
[0] *	DISABLED	Ignores <i>13-42 Logic Rule Boolean 2</i> , <i>13-43 Logic Rule Operator 2</i> , and <i>13-44 Logic Rule Boolean 3</i> .
[1]	AND	Evaluates the expression [13-40] AND [13-42].
[2]	OR	Evaluates the expression [13-40] OR [13-42].
[3]	AND NOT	Evaluates the expression [13-40] AND NOT [13-42].
[4]	OR NOT	Evaluates the expression [13-40] OR NOT [13-42].
[5]	NOT AND	Evaluates the expression NOT [13-40] AND [13-42].
[6]	NOT OR	Evaluates the expression NOT [13-40] OR [13-42].
[7]	NOT AND NOT	Evaluates the expression NOT [13-40] AND NOT [13-42].
[8]	NOT OR NOT	Evaluates the expression NOT [13-40] OR NOT [13-42].

13-42 Logic Rule Boolean 2		
Array [6]		
Option:	Function:	
		Select the second boolean (TRUE or FALSE) input for the selected logic rule. See <i>13-40 Logic Rule Boolean 1</i> for further descriptions of choices and their functions.
[0] *	False	
[1]	True	
[2]	Running	

13-42 Logic Rule Boolean 2		
Array [6]		
Option:	Function:	
[3]	In range	
[4]	On reference	
[5]	Torque limit	
[6]	Current Limit	
[7]	Out of current range	
[8]	Below I low	
[9]	Above I high	
[10]	Out of speed range	
[11]	Below speed low	
[12]	Above speed high	
[13]	Out of feedb. range	
[14]	Below feedb. low	
[15]	Above feedb. high	
[16]	Thermal warning	
[17]	Mains out of range	
[18]	Reversing	
[19]	Warning	
[20]	Alarm (trip)	
[21]	Alarm (trip lock)	
[22]	Comparator 0	
[23]	Comparator 1	
[24]	Comparator 2	
[25]	Comparator 3	
[26]	Logic rule 0	
[27]	Logic rule 1	
[28]	Logic rule 2	
[29]	Logic rule 3	
[30]	SL Time-out 0	
[31]	SL Time-out 1	
[32]	SL Time-out 2	
[33]	Digital input DI18	
[34]	Digital input DI19	
[35]	Digital input DI27	
[36]	Digital input DI29	
[37]	Digital input DI32	
[38]	Digital input DI33	
[39]	Start command	
[40]	Drive stopped	
[41]	Reset Trip	
[42]	Auto Reset Trip	
[43]	OK Key	
[44]	Reset Key	
[45]	Left Key	
[46]	Right Key	
[47]	Up Key	
[48]	Down Key	
[50]	Comparator 4	
[51]	Comparator 5	
[60]	Logic rule 4	
[61]	Logic rule 5	
[70]	SL Time-out 3	

13-42 Logic Rule Boolean 2		
Array [6]		
Option:	Function:	
[71]	SL Time-out 4	
[72]	SL Time-out 5	
[73]	SL Time-out 6	
[74]	SL Time-out 7	
[80]	No Flow	
[81]	Dry Pump	
[82]	End of Curve	
[83]	Broken Belt	

13-43 Logic Rule Operator 2		
Array [6]		
Option:	Function:	
		Select the second logical operator to be used on the boolean input calculated in 13-40 Logic Rule Boolean 1, 13-41 Logic Rule Operator 1, and 13-42 Logic Rule Boolean 2, and the boolean input coming from 13-42 Logic Rule Boolean 2. [13-44] signifies the boolean input of 13-44 Logic Rule Boolean 3. [13-40/13-42] signifies the boolean input calculated in 13-40 Logic Rule Boolean 1, 13-41 Logic Rule Operator 1, and 13-42 Logic Rule Boolean 2. [0] DISABLED (factory setting). select this option to ignore 13-44 Logic Rule Boolean 3.
[0] *	DISABLED	
[1]	AND	
[2]	OR	
[3]	AND NOT	
[4]	OR NOT	
[5]	NOT AND	
[6]	NOT OR	
[7]	NOT AND NOT	
[8]	NOT OR NOT	

13-44 Logic Rule Boolean 3		
Array [6]		
Option:	Function:	
		Select the third boolean (TRUE or FALSE) input for the selected logic rule. See 13-40 Logic Rule Boolean 1 for further descriptions of choices and their functions.
[0] *	False	
[1]	True	
[2]	Running	
[3]	In range	
[4]	On reference	
[5]	Torque limit	

13-44 Logic Rule Boolean 3		
Array [6]		
Option:	Function:	
[6]	Current Limit	
[7]	Out of current range	
[8]	Below I low	
[9]	Above I high	
[10]	Out of speed range	
[11]	Below speed low	
[12]	Above speed high	
[13]	Out of feedb. range	
[14]	Below feedb. low	
[15]	Above feedb. high	
[16]	Thermal warning	
[17]	Mains out of range	
[18]	Reversing	
[19]	Warning	
[20]	Alarm (trip)	
[21]	Alarm (trip lock)	
[22]	Comparator 0	
[23]	Comparator 1	
[24]	Comparator 2	
[25]	Comparator 3	
[26]	Logic rule 0	
[27]	Logic rule 1	
[28]	Logic rule 2	
[29]	Logic rule 3	
[30]	SL Time-out 0	
[31]	SL Time-out 1	
[32]	SL Time-out 2	
[33]	Digital input DI18	
[34]	Digital input DI19	
[35]	Digital input DI27	
[36]	Digital input DI29	
[37]	Digital input DI32	
[38]	Digital input DI33	
[39]	Start command	
[40]	Drive stopped	
[41]	Reset Trip	
[42]	Auto Reset Trip	
[43]	OK Key	
[44]	Reset Key	
[45]	Left Key	
[46]	Right Key	
[47]	Up Key	
[48]	Down Key	
[50]	Comparator 4	
[51]	Comparator 5	
[60]	Logic rule 4	
[61]	Logic rule 5	
[70]	SL Time-out 3	
[71]	SL Time-out 4	
[72]	SL Time-out 5	
[73]	SL Time-out 6	

13-44 Logic Rule Boolean 3		
Array [6]		
Option:	Function:	
[74]	SL Time-out 7	
[80]	No Flow	
[81]	Dry Pump	
[82]	End of Curve	
[83]	Broken Belt	

3.10.6 13-5* States

13-51 SL Controller Event		
Array [20]		
Option:	Function:	
		Select the boolean input (TRUE or FALSE) to define the Smart Logic Controller event. See 13-02 Stop Event for further descriptions of choices and their functions.
[0] *	False	
[1]	True	
[2]	Running	
[3]	In range	
[4]	On reference	
[5]	Torque limit	
[6]	Current Limit	
[7]	Out of current range	
[8]	Below I low	
[9]	Above I high	
[10]	Out of speed range	
[11]	Below speed low	
[12]	Above speed high	
[13]	Out of feedb. range	
[14]	Below feedb. low	
[15]	Above feedb. high	
[16]	Thermal warning	
[17]	Mains out of range	
[18]	Reversing	
[19]	Warning	
[20]	Alarm (trip)	
[21]	Alarm (trip lock)	
[22]	Comparator 0	
[23]	Comparator 1	
[24]	Comparator 2	
[25]	Comparator 3	
[26]	Logic rule 0	
[27]	Logic rule 1	
[28]	Logic rule 2	
[29]	Logic rule 3	
[30]	SL Time-out 0	
[31]	SL Time-out 1	
[32]	SL Time-out 2	

13-51 SL Controller Event		
Array [20]		
Option:	Function:	
[33]	Digital input DI18	
[34]	Digital input DI19	
[35]	Digital input DI27	
[36]	Digital input DI29	
[37]	Digital input DI32	
[38]	Digital input DI33	
[39]	Start command	
[40]	Drive stopped	
[41]	Reset Trip	
[42]	Auto Reset Trip	
[43]	OK Key	
[44]	Reset Key	
[45]	Left Key	
[46]	Right Key	
[47]	Up Key	
[48]	Down Key	
[50]	Comparator 4	
[51]	Comparator 5	
[60]	Logic rule 4	
[61]	Logic rule 5	
[70]	SL Time-out 3	
[71]	SL Time-out 4	
[72]	SL Time-out 5	
[73]	SL Time-out 6	
[74]	SL Time-out 7	
[80]	No Flow	
[81]	Dry Pump	
[82]	End of Curve	
[83]	Broken Belt	

3.11 Main Menu - Special Functions - Group 14

3.11.1 14-** Special Functions

Parameter group for configuring special frequency converter functions.

3.11.2 14-0* Inverter Switching

14-00 Switching Pattern		
Option:	Function:	
		Select the switching pattern: 60° AVM or SFAVM.
[0] *	60 AVM	
[1]	SFAVM	

14-01 Switching Frequency		
Option:	Function:	
		Select the inverter switching frequency. Changing the switching frequency can help to reduce acoustic noise from the motor.
		NOTE The output frequency value of the frequency converter must never exceed 1/10 of the switching frequency. When the motor is running, adjust the switching frequency in <i>14-01 Switching Frequency</i> until the motor is as noiseless as possible. See also <i>14-00 Switching Pattern</i> and the section <i>Derating</i> .
[0]	1.0 kHz	
[1]	1.5 kHz	
[2]	2.0 kHz	
[3]	2.5 kHz	
[4]	3.0 kHz	
[5]	3.5 kHz	
[6]	4.0 kHz	
[7] *	5.0 kHz	
[8]	6.0 kHz	
[9]	7.0 kHz	
[10]	8.0 kHz	
[11]	10.0 kHz	
[12]	12.0kHz	
[13]	14.0 kHz	
[14]	16.0kHz	

NOTE

Enabling over-modulation can cause vibrations that may destroy the mechanics if running in field weakening areas (from 47 Hz).

14-03 Overmodulation		
Option:	Function:	
[0]	Off	Selects no over-modulation of the output voltage in order to avoid torque ripple on the motor shaft.
[1] *	On	The over-modulation function generates an extra voltage of up-to 8% of U_{max} output voltage without over-modulation, which results in an extra torque of 10-12% in the middle of the over-synchronous range (from 0% at nominal speed rising to approximately 12% at double nominal speed).

14-04 PWM Random		
Option:	Function:	
[0] *	Off	No change of the acoustic motor switching noise.
[1]	On	Transforms the acoustic motor switching noise from a clear ringing tone to a less noticeable 'white' noise. This is achieved by slightly and randomly altering the synchronism of the pulse width modulated output phases.

3.11.3 14-1* Mains On/Off

Parameters for configuring mains failure monitoring and handling.

14-12 Function at Mains Imbalance		
Option:	Function:	
		Operation under severe main imbalance conditions reduces the lifetime of the motor. Conditions are considered severe if the motor is operated continuously near nominal load (e.g. a pump or fan running near full speed). When a severe mains imbalance is detected:
[0] *	Trip	Select [0] <i>Trip</i> to trip the frequency converter.
[1]	Warning	Select [1] <i>Warning</i> to issue a warning.
[2]	Disabled	Select [2] <i>Disabled</i> for no action.
[3]	Derate	Select [3] <i>Derate</i> for derating the frequency converter.

Parameters for configuring auto reset handling, special trip handling and control card self test or initialisation.

14-20 Reset Mode		
Option:	Function:	
[0] *	Manual reset	Select [0] <i>Manual reset</i> , to perform a reset via [Reset] or via the digital inputs.
[1]	Automatic reset x 1	Select [1]-[12] <i>Automatic reset x 1...x20</i> to perform between one and twenty automatic resets after tripping.
[2]	Automatic reset x 2	

14-20 Reset Mode

Select the reset function after tripping. Once reset, the frequency converter can be restarted.

Option:
Function:

[3]	Automatic reset x 3	
[4]	Automatic reset x 4	
[5]	Automatic reset x 5	
[6]	Automatic reset x 6	
[7]	Automatic reset x 7	
[8]	Automatic reset x 8	
[9]	Automatic reset x 9	
[10]	Automatic reset x 10	
[11]	Automatic reset x 15	
[12]	Automatic reset x 20	
[13]	Infinite Automatic Reset	Select [13] <i>Infinite Automatic Reset</i> for continuous resetting after tripping.

Application Tip:

If 14-20 *Reset Mode*/14-21 *Automatic Restart Time* is set to auto-reset after e.g. 30 s this should be taken in consideration if a relay output is set to call for a service technician in case of an alarm.

By setting 5-40 *Function Relay* to [9] *Alarm* and 5-41 *On Delay, Relay* to 40 s, the relay will only activate at either a trip lock alarm or an alarm, which could not be auto-reset. Only the relay output can be used for this; the digital outputs do not have the On Delay feature.

NOTE

The motor may start without warning. If the specified number of automatic resets is reached within 10 minutes, the frequency converter enters [0] *Manual reset mode*. After the Manual reset is performed, the setting of 14-20 *Reset Mode* reverts to the original selection. If the number of automatic resets is not reached within 10 minutes, or when a Manual reset is performed, the internal automatic reset counter returns to zero.

NOTE

Automatic reset will also be active for resetting safe stop function in firmware version < 4.3x.

NOTE

The setting in 14-20 *Reset Mode* is disregarded in case of Fire Mode being active (see parameter group 24-0*, *Fire Mode*).

14-21 Automatic Restart Time
Range:
Function:

300 s*	[0 - 600 s]	Enter the time interval from trip to start of the automatic reset function. This parameter is active when 14-20 <i>Reset Mode</i> is set to [1] - [13] <i>Automatic reset</i> .
--------	-------------	---

14-22 Operation Mode
Option:
Function:

		Use this parameter to specify normal operation, to perform tests or to initialise all parameters except 15-03 <i>Power Up's</i> , 15-04 <i>Over Temp's</i> and 15-05 <i>Over Volt's</i> . This function is active only when the power is cycled (power off-power on) to the frequency converter.
[0] *	Normal operation	Select [0] <i>Normal operation</i> for normal operation of the frequency converter with the motor in the selected application.
[1]	Control card test	<p>Select [1] <i>Control card test</i> to test the analog and digital inputs and outputs and the +10 V control voltage. The test requires a test connector with internal connections.</p> <p>Use the following procedure for the control card test:</p> <ol style="list-style-type: none"> Select [1] <i>Control card test</i>. Disconnect the mains supply and wait for the light in the display to go out. Set switches S201 (A53) and S202 (A54) = 'ON'/I. Insert the test plug (see <i>Illustration 3.33</i>). Connect to mains supply. Carry out various tests. The results are displayed on the LCP and the frequency converter moves into an infinite loop. 14-22 <i>Operation Mode</i> is automatically set to Normal operation. Carry out a power cycle to start up in Normal operation after a control card test. <p>If the test is OK: LCP read-out: Control Card OK. Disconnect the mains supply and remove the test plug. The green LED on the control card will light up.</p> <p>If the test fails: LCP read-out: Control Card I/O failure. Replace the frequency converter or control card. The red LED on the control card is turned on. To test the plugs, connect/group the following terminals as shown in <i>Illustration 3.33</i>: (18 - 27 - 32), (19 - 29 - 33) and (42 - 53 - 54).</p>

14-22 Operation Mode		
Option:	Function:	
	<p style="text-align: center;">Illustration 3.33 Wiring Control Card Test</p>	
[2]	Initialisation	Select [2] <i>Initialisation</i> to reset all parameter values to default settings, except for 15-03 <i>Power Up's</i> , 15-04 <i>Over Temp's</i> and 15-05 <i>Over Volt's</i> . The frequency converter will reset during the next power-up. 14-22 <i>Operation Mode</i> will also revert to the default setting [0] <i>Normal operation</i> .
[3]	Boot mode	

14-23 Typecode Setting		
Option:	Function:	
	Typecode re-writing. Use this parameter to set the typecode matching the specific frequency converter.	

14-25 Trip Delay at Torque Limit		
Range:	Function:	
60 s* [0 - 60 s]	Enter the torque limit trip delay in seconds. When the output torque reaches the torque limits (4-16 <i>Torque Limit Motor Mode</i> and 4-17 <i>Torque Limit Generator Mode</i>), a warning is triggered. When the torque limit warning has been continuously present for the period specified in this parameter, the frequency converter trips. Disable the trip delay by setting the parameter to 60 s = OFF. Thermal frequency converter monitoring will still remain active.	

14-26 Trip Delay at Inverter Fault		
Range:	Function:	
Size related* [0 - 35 s]	When the frequency converter detects an over-voltage in the set time trip will be effected after the set time.	

14-28 Production Settings		
Option:	Function:	
[0] *	No action	
[1]	Service reset	

14-29 Service Code		
Range:	Function:	
0 *	[-2147483647 - 2147483647] Service use only.	

3.11.4 14-3* Current Limit Control

The frequency converter features an integral Current Limit Controller which is activated when the motor current, and thus the torque, is higher than the torque limits set in 4-16 *Torque Limit Motor Mode* and 4-17 *Torque Limit Generator Mode*.

When the current limit is reached during motor operation or regenerative operation, the frequency converter will try to reduce torque below the preset torque limits as quickly as possible without losing control of the motor.

While the current control is active, the frequency converter can only be stopped by setting a digital input to [2] *Coast inverse* or [3] *Coast and reset inv.*. Any signal on terminals 18 to 33 will not be active until the frequency converter is no longer near the current limit.

By using a digital input set to [2] *Coast inverse* or [3] *Coast and reset inv.*, the motor does not use the ramp down time, since the frequency converter is coasted.

14-30 Current Lim Ctrl, Proportional Gain		
Range:	Function:	
100 %* [0 - 500 %]	Enter the proportional gain value for the current limit controller. Selection of a high value makes the controller react faster. Too high a setting leads to controller instability.	

14-31 Current Lim Ctrl, Integration Time		
Range:	Function:	
Size related* [0.002 - 2 s]	Controls the current limit control integration time. Setting it to a lower value makes it react faster. A setting too low leads to control instability.	

14-32 Current Lim Ctrl, Filter Time		
Range:	Function:	
Size related* [1 - 100 ms]	Sets a time constant for the current limit controller low-pass filter.	

3.11.5 14-4* Energy Optimising

Parameters for adjusting the energy optimisation level in both Variable Torque (VT) and Automatic Energy Optimization (AEO) mode.

Automatic Energy Optimization is only active if 1-03 *Torque Characteristics*, is set for either [2] *Auto Energy Optim. Compressor* or [3] *Auto Energy Optim. VT*.

14-40 VT Level		
Range:		Function:
66 %*	[40 - 90 %]	Enter the level of motor magnetisation at low speed. Selection of a low value reduces energy loss in the motor, but also reduces load capability.

NOTE

This parameter cannot be adjusted while the motor is running.

NOTE

This parameter is not active when *1-10 Motor Construction* is set to [1] *PM non salient SPM*.

14-41 AEO Minimum Magnetisation		
Range:		Function:
Size related*	[40 - 75 %]	Enter the minimum allowable magnetisation for AEO. Selection of a low value reduces energy loss in the motor, but can also reduce resistance to sudden load changes.

NOTE

This parameter is not active when *1-10 Motor Construction* is set to [1] *PM non salient SPM*.

14-42 Minimum AEO Frequency		
Range:		Function:
10 Hz*	[5 - 40 Hz]	Enter the minimum frequency at which the Automatic Energy Optimisation (AEO) is to be active.

NOTE

This parameter is not active when *1-10 Motor Construction* is set to [1] *PM non salient SPM*.

14-43 Motor Cosphi		
Range:		Function:
Size related*	[0.40 - 0.95]	The Cos(phi) setpoint is automatically set for optimum AEO performance during AMA. This parameter should normally not be altered. However in some situations it may be necessary to enter a new value to fine-tune.

NOTE

This parameter is not active when *1-10 Motor Construction* is set to [1] *PM non salient SPM*.

3.11.6 14-5* Environment

These parameters help the frequency converter to operate under special environmental conditions.

14-50 RFI Filter		
This parameter is only available for . It is not relevant to due to different design and shorter motor cables.		
Option:		Function:
[0]	Off	Select [0] <i>Off</i> if the frequency converter is fed by an isolated mains source (IT mains). If a filter is used, select Off [0] during charging to prevent a high leakage current making the RCD switch. In this mode, the internal RFI filter capacitors between chassis and the mains RFI filter circuit are cut-out to reduce the ground capacity currents.
[1]	* On	Select [1] <i>On</i> to ensure that the frequency converter complies with EMC standards.

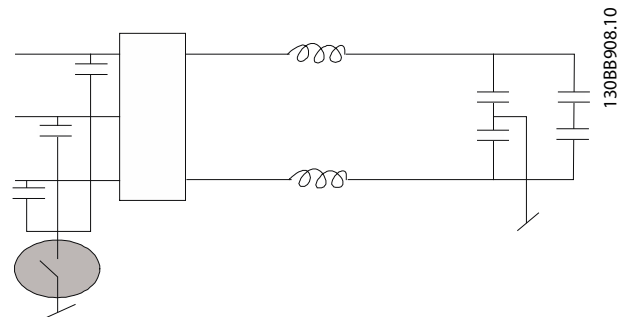

Illustration 3.34

14-52 Fan Control		
Option:		Function:
		Select the minimum speed of the main fan.
[0]	* Auto	Select [0] <i>Auto</i> to run the fan only when the internal temperature of the frequency converter is in the range +35 °C to approximately +55 °C. The fan will run at low speed at +35 °C and at full speed at approximately +55 °C.
[1]	On 50%	
[2]	On 75%	
[3]	On 100%	

14-53 Fan Monitor		
Option:		Function:
		Select which reaction the frequency converter should take in case a fan fault is detected.
[0]	Disabled	
[1]	* Warning	
[2]	Trip	

14-55 Output Filter		
Option:		Function:
		Select the type of output filter connected. This parameter cannot be adjusted while motor is running.

14-55 Output Filter		
Option:	Function:	
[0] *	No Filter	This is the default setting and should be used with dU/dt filters or high-frequency common-mode (HF-CM) filters.
[1]	Sine-Wave Filter	This setting is only for backwards compatibility. It enables operation with FLUX control principle when the parameters <i>14-56 Capacitance Output Filter</i> and <i>14-57 Inductance Output Filter</i> are programmed with the output filter capacitance and inductance. It DOES NOT limit the range of the switching frequency.

3.11.7 14-6* Auto Derate

This group contains parameters for derating the frequency converter in case of high temperature.

14-60 Function at Over Temperature		
Option:	Function:	
		If either heatsink or control card temperature exceeds a factory-programmed temperature limit, a warning will be activated. If the temperature increases further, select whether the frequency converter should trip (trip locked) or derate the output current.
[0] *	Trip	The frequency converter will trip (trip locked) and generate an alarm. Power must be cycled to reset the alarm, but will not allow restart of the motor until the heat sink temperature has dropped below the alarm limit.
[1]	Derate	If the critical temperature is exceeded the output current will be reduced until the allowable temperature has been reached.

3.11.8 No Trip at Inverter Overload

In some pump systems, the frequency converter has not been sized properly to yield the current needed in all points of the operational flow-head characteristic. At these points, the pump will need a current higher than the rated current of the frequency converter. The frequency converter can yield 110% of the rated current continuously for 60 s. If still overloaded, the frequency converter will normally trip (causing the pump to stop by coasting) and provide an alarm.

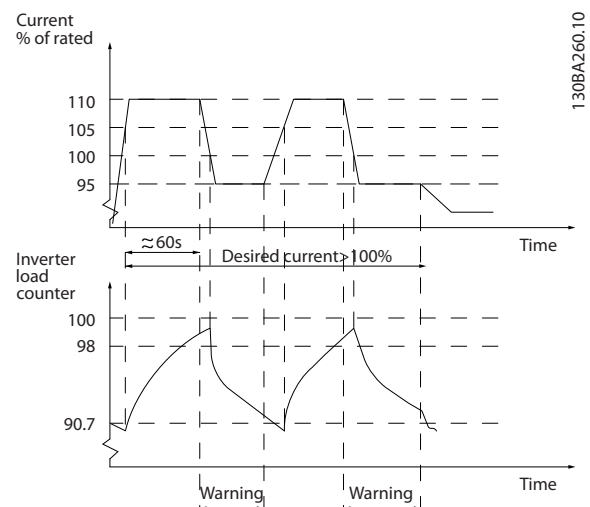

Illustration 3.35

It may be preferable to run the pump at reduced speed for a while in case it is not possible to run continuously with demanded capacity.

Select *14-61 Function at Inverter Overload* to automatically reduce pump speed until the output current is below 100% of the rated current (set in *14-62 Inv. Overload Derate Current*).

14-61 Function at Inverter Overload is an alternative to letting the frequency converter trip.

The frequency converter estimates the load on the power section by means of an inverter load counter, which will cause a warning at 98% and a reset of the warning at 90%. At the value 100%, the frequency converter trips and provides an alarm.

Status for the counter can be read in *16-35 Inverter Thermal*.

If *14-61 Function at Inverter Overload* is set to *[3] Derate*, the pump speed will be reduced when the counter exceeds 98, and stay reduced until the counter has dropped below 90.7.

If *14-62 Inv. Overload Derate Current* is set e.g. to 95% a steady overload will cause the pump speed to fluctuate between values corresponding to 110% and 95% of rated output current for the frequency converter.

14-61 Function at Inverter Overload		
Option:	Function:	
		Is used in case of steady overload beyond the thermal limits (110% for 60 sec.).
[0] *	Trip	Choose <i>[0] Trip</i> to make the frequency converter trip and provide an alarm.
[1]	Derate	<i>[1] Derate</i> to reduce pump speed in order to decrease the load on the power section and allowing this to cool down.

3

14-62 Inv. Overload Derate Current		
Range:		Function:
95 %*	[50 - 100 %]	Defines the desired current level (in % of rated output current for the frequency converter) when running with reduced pump speed after load on the frequency converter has exceeded the allowable limit (110% for 60 s).

3.12 Main Menu - Frequency Converter Information - Group 15

Parameter group containing frequency converter information such as operating data, hardware configuration and software versions.

3.12.1 15-0* Operating Data

15-00 Operating hours		
Range:	Function:	
0 h* [0 - 2147483647 h]	View how many hours the frequency converter has run. The value is saved when the frequency converter is turned off.	

15-01 Running Hours		
Range:	Function:	
0 h* [0 - 2147483647 h]	View how many hours the motor has run. Reset the counter in <i>15-07 Reset Running Hours Counter</i> . The value is saved when the frequency converter is turned off.	

15-02 kWh Counter		
Range:	Function:	
0 kWh* [0 - 2147483647 kWh]	Registering the power consumption of the motor as a mean value over one hour. Reset the counter in <i>15-06 Reset kWh Counter</i> .	

15-03 Power Up's		
Range:	Function:	
0 * [0 - 2147483647]	View the number of times the frequency converter has been powered up.	

15-04 Over Temp's		
Range:	Function:	
0 * [0 - 65535]	View the number of frequency converter temperature faults which have occurred.	

15-05 Over Volt's		
Range:	Function:	
0 * [0 - 65535]	View the number of frequency converter overvoltages which have occurred.	

15-06 Reset kWh Counter		
Option:	Function:	
[0] * Do not reset	Select [0] <i>Do not reset</i> if no reset of the kWh counter is desired.	
[1] Reset counter	Select [1] <i>Reset</i> and press [OK] to reset the kWh counter to zero (see <i>15-02 kWh Counter</i>).	

NOTE

The reset is carried out by pressing [OK].

15-07 Reset Running Hours Counter		
Option:	Function:	
[0] * Do not reset	Select [0] <i>Do not reset</i> if no reset of the Running Hours counter is desired.	
[1] Reset counter	Select [1] <i>Reset counter</i> and press [OK] to reset the Running Hours counter (<i>15-01 Running Hours</i>) and <i>15-08 Number of Starts</i> to zero (see also <i>15-01 Running Hours</i>).	

15-08 Number of Starts		
Range:	Function:	
0 * [0 - 2147483647]	This is a read out parameter only. The counter shows the numbers of starts and stops caused by a normal Start/Stop command and/or when entering/leaving sleep mode.	

NOTE

This parameter will be reset when resetting *15-07 Reset Running Hours Counter*.

3.12.2 15-1* Data Log Settings

The Data Log enables continuous logging of up to 4 data sources (*15-10 Logging Source*) at individual rates (*15-11 Logging Interval*). A trigger event (*15-12 Trigger Event*) and window (*15-14 Samples Before Trigger*) are used to start and stop the logging conditionally.

15-10 Logging Source		
Array [4]		
Option:	Function:	
		Select which variables are to be logged.
[0] * None		
[1600] Control Word		
[1601] Reference [Unit]		
[1602] Reference [%]		
[1603] Status Word		
[1610] Power [kW]		
[1611] Power [hp]		
[1612] Motor Voltage		
[1613] Frequency		
[1614] Motor current		
[1616] Torque [Nm]		
[1617] Speed [RPM]		
[1618] Motor Thermal		
[1630] DC Link Voltage		
[1632] Brake Energy /s		
[1633] Brake Energy /2 min		
[1634] Heatsink Temp.		

15-10 Logging Source		
Array [4]		
Option:	Function:	
[1635]	Inverter Thermal	
[1650]	External Reference	
[1652]	Feedback[Unit]	
[1660]	Digital Input	
[1662]	Analog Input 53	
[1664]	Analog Input 54	
[1665]	Analog Output 42 [mA]	
[1666]	Digital Output [bin]	
[1690]	Alarm Word	
[1692]	Warning Word	
[1694]	Ext. Status Word	

15-11 Logging Interval		
Array [4]		
Range:	Function:	
Size related*	[0 - 0]	Enter the interval in milliseconds between each sampling of the variables to be logged.

15-12 Trigger Event		
Option:	Function:	
		Selects the trigger event. When the trigger event occurs, a window is applied to freeze the log. The log will then retain a specified percentage of samples before the occurrence of the trigger event (<i>15-14 Samples Before Trigger</i>).
[0] *	False	
[1]	True	
[2]	Running	
[3]	In range	
[4]	On reference	
[5]	Torque limit	
[6]	Current Limit	
[7]	Out of current range	
[8]	Below I low	
[9]	Above I high	
[10]	Out of speed range	
[11]	Below speed low	
[12]	Above speed high	
[13]	Out of feedb. range	
[14]	Below feedb. low	
[15]	Above feedb. high	
[16]	Thermal warning	
[17]	Mains out of range	
[18]	Reversing	
[19]	Warning	
[20]	Alarm (trip)	
[21]	Alarm (trip lock)	
[22]	Comparator 0	

15-12 Trigger Event		
Option:	Function:	
[23]	Comparator 1	
[24]	Comparator 2	
[25]	Comparator 3	
[26]	Logic rule 0	
[27]	Logic rule 1	
[28]	Logic rule 2	
[29]	Logic rule 3	
[33]	Digital input DI18	
[34]	Digital input DI19	
[35]	Digital input DI27	
[36]	Digital input DI29	
[37]	Digital input DI32	
[38]	Digital input DI33	
[50]	Comparator 4	
[51]	Comparator 5	
[60]	Logic rule 4	
[61]	Logic rule 5	

15-13 Logging Mode		
Option:	Function:	
[0] *	Log always	Select [0] <i>Log always</i> for continuous logging.
[1]	Log once on trigger	Select [1] <i>Log once on trigger</i> to conditionally start and stop logging using <i>15-12 Trigger Event</i> and <i>15-14 Samples Before Trigger</i> .

15-14 Samples Before Trigger		
Range:	Function:	
50 *	[0 - 100]	Enter the percentage of all samples before a trigger event which are to be retained in the log. See also <i>15-12 Trigger Event</i> and <i>15-13 Logging Mode</i> .

3.12.3 15-2* Historic Log

View up to 50 logged data items via the array parameters in this parameter group. For all parameters in the group, [0] is the most recent data and [49] the oldest data. Data is logged every time an *event* occurs (not to be confused with SLC events). *Events* in this context are defined as a change in one of the following areas

1. Digital input
2. Digital outputs (not monitored in this SW release)
3. Warning word
4. Alarm word
5. Status word
6. Control word
7. Extended status word

Events are logged with value, and time stamp in ms. The time interval between two events depends on how often events occur (maximum once every scan time). Data logging is continuous but if an alarm occurs, the log is saved and the values can be viewed on the display. This feature is useful, for example when carrying out service following a trip. View the historic log contained in this parameter via the serial communication port or via the display.

15-20 Historic Log: Event		
Array [50]		
Range:		Function:
0 *	[0 - 255]	View the event type of the logged events.

15-21 Historic Log: Value		
Array [50]		
Range:		Function:
0 *	[0 - 2147483647]	View the value of the logged event. Interpret the event values according to this table:
	Digital input	Decimal value. See 16-60 Digital Input for description after converting to binary value.
	Digital output (not monitored in this SW release)	Decimal value. See 16-66 Digital Output [bin] for description after converting to binary value.
	Warning word	Decimal value. See 16-92 Warning Word for description.
	Alarm word	Decimal value. See 16-90 Alarm Word for description.
	Status word	Decimal value. See 16-03 Status Word for description after converting to binary value.
	Control word	Decimal value. See 16-00 Control Word for description.
	Extended status word	Decimal value. See 16-94 Ext. Status Word for description.
Table 3.16		

15-22 Historic Log: Time		
Array [50]		
Range:		Function:
0 ms*	[0 - 2147483647 ms]	View the time at which the logged event occurred. Time is measured in ms since frequency converter start. The max. value corresponds to approx. 24 days which means that the count will restart at zero after this time period.

15-23 Historic log: Date and Time		
Array [50]		
Range:		Function:
Size related*	[0 - 0]	Array parameter; Date & Time 0 - 49: This parameter shows at which time the logged event occurred.

3

3.12.4 15-3* Alarm Log

Parameters in this group are array parameters, where up to 10 fault logs can be viewed. [0] is the most recent logged data, and [9] the oldest. Error codes, values, and time stamp can be viewed for all logged data.

15-30 Alarm Log: Error Code		
Array [10]		
Range:		Function:
0 *	[0 - 255]	View the error code and look up its meaning in .

15-31 Alarm Log: Value		
Array [10]		
Range:		Function:
0 *	[-32767 - 32767]	View an extra description of the error. This parameter is mostly used in combination with alarm 38 'internal fault'.

15-32 Alarm Log: Time		
Array [10]		
Range:		Function:
0 s*	[0 - 2147483647 s]	View the time when the logged event occurred. Time is measured in seconds from frequency converter start-up.

15-33 Alarm Log: Date and Time		
Array [10]		
Range:		Function:
Size related*	[0 - 0]	Array parameter; Date & Time 0 - 9: This parameter shows at which time the logged event occurred.

3.12.5 15-4* Drive Identification

Parameters containing read only information about the hardware and software configuration of the frequency converter.

15-40 FC Type

Option: Function:

	View the FC type. The read-out is identical to the ADAP-KOOL Drive Series power field of the type code definition, characters 1-6.
--	--

15-41 Power Section

Option: Function:

	View the FC type. The read-out is identical to the ADAP-KOOL Drive Series power field of the type code definition, characters 7-10.
--	---

15-42 Voltage

Option: Function:

	View the FC type. The read-out is identical to the ADAP-KOOL Drive Series power field of the type code definition, characters 11-12.
--	--

15-43 Software Version

Range: Function:

0 *	[0 - 0]	View the combined SW version (or 'package version') consisting of power SW and control SW.
-----	----------	--

15-44 Ordered Typecode String

Range: Function:

0 *	[0 - 0]	View the type code string used for re-ordering the frequency converter in its original configuration.
-----	----------	---

15-45 Actual Typecode String

Range: Function:

0 *	[0 - 0]	View the actual type code string.
-----	----------	-----------------------------------

15-46 Frequency Converter Ordering No

Range: Function:

0 *	[0 - 0]	View the 8-digit ordering number used for re-ordering the frequency converter in its original configuration.
-----	----------	--

15-47 Power Card Ordering No

Range: Function:

0 *	[0 - 0]	View the power card ordering number.
-----	----------	--------------------------------------

15-48 LCP Id No

Range: Function:

0 *	[0 - 0]	View the LCP ID number.
-----	----------	-------------------------

15-49 SW ID Control Card

Range: Function:

0 *	[0 - 0]	View the control card software version number.
-----	----------	--

15-50 SW ID Power Card

Range: Function:

0 *	[0 - 0]	View the power card software version number.
-----	----------	--

15-51 Frequency Converter Serial Number

Range: Function:

0 *	[0 - 0]	View the frequency converter serial number.
-----	----------	---

15-53 Power Card Serial Number

Range: Function:

0 *	[0 - 0]	View the power card serial number.
-----	----------	------------------------------------

3.12.6 15-6* Option Ident.

This read-only parameter group contains information about the hardware and software configuration of the options installed in slots A, B, C0 and C1.

15-60 Option Mounted

Array [8]

Range: Function:

0 *	[0 - 0]	View the installed option type.
-----	----------	---------------------------------

15-61 Option SW Version

Array [8]

Range: Function:

0 *	[0 - 0]	View the installed option software version.
-----	----------	---

15-62 Option Ordering No

Array [8]

Range: Function:

0 *	[0 - 0]	Shows the ordering number for the installed options.
-----	----------	--

15-63 Option Serial No

Array [8]

Range: Function:

0 *	[0 - 0]	View the installed option serial number.
-----	----------	--

15-70 Option in Slot A		
Range:	Function:	
0 *	[0 - 0]	View the type code string for the option installed in slot A, and a translation of the type code string. E.g. for type code string 'AX' the translation is 'No option'.

15-71 Slot A Option SW Version		
Range:	Function:	
0 *	[0 - 0]	View the software version for the option installed in slot A.

15-72 Option in Slot B		
Range:	Function:	
0 *	[0 - 0]	View the type code string for the option installed in slot B, and a translation of the type code string. E.g. for type code string 'BX' the translation is 'No option'.

15-73 Slot B Option SW Version		
Range:	Function:	
0 *	[0 - 0]	View the software version for the option installed in slot B.

15-74 Option in Slot C0/E0		
Range:	Function:	
0 *	[0 - 0]	View the type code string for the option installed in slot C, and a translation of the type code string. E.g. for type code string 'CXXXX' the translation is 'No option'.

15-75 Slot C0/E0 Option SW Version		
Range:	Function:	
0 *	[0 - 0]	View the software version for the option installed in slot C.

15-76 Option in Slot C1/E1		
Range:	Function:	
0 *	[0 - 0]	Shows the typecode string for the options (CXXXX if no option) and the translation i.e. >No option<.

15-77 Slot C1/E1 Option SW Version		
Range:	Function:	
0 *	[0 - 0]	Software version for the installed option in option slot C.

15-92 Defined Parameters		
Array [1000]		
Range:	Function:	
0 *	[0 - 9999]	View a list of all defined parameters in the frequency converter. The list ends with 0.

15-93 Modified Parameters		
Array [1000]		
Range:	Function:	
0 *	[0 - 9999]	View a list of the parameters that have been changed from their default setting. The list ends with 0. Changes may not be visible until up to 30 s after implementation.

15-98 Drive Identification		
Range:	Function:	
0 N/A*	[0 - 0 N/A]	

15-99 Parameter Metadata		
Array [23]		
Range:	Function:	
0 *	[0 - 9999]	This parameter contains data used by the software tool.

3.13 Main Menu - Data Readouts - Group 16

16-00 Control Word		
Range:	Function:	
0 * [0 - 65535]	View the Control word sent from the frequency converter via the serial communication port in hex code.	

16-01 Reference [Unit]		
Range:	Function:	
0 ReferenceFeed-backUnit*	[-999999 - 999999 ReferenceFeed-backUnit]	View the present reference value applied on impulse or analog basis in the unit resulting from the configuration selected in <i>1-00 Configuration Mode</i> (Hz, Nm or RPM).

16-02 Reference [%]		
Range:	Function:	
0 %* [-200 - 200 %]	View the total reference. The total reference is the sum of digital, analog, preset, bus, and freeze references, plus catch-up and slow-down.	

16-03 Status Word		
Range:	Function:	
0 * [0 - 65535]	View the Status word sent from the frequency converter via the serial communication port in hex code.	

16-05 Main Actual Value [%]		
Range:	Function:	
0 %* [-100 - 100 %]	View the two-byte word sent with the Status word to the bus Master reporting the Main Actual Value.	

16-09 Custom Readout		
Range:	Function:	
0 CustomReadoutUnit*	[-999999.99 - 999999.99 CustomReadoutUnit]	View the user-defined readouts as defined in <i>0-30 Custom Readout Unit</i> , <i>0-31 Custom Readout Min Value</i> and <i>0-32 Custom Readout Max Value</i> .

16-10 Power [kW]		
Range:	Function:	
		filtered, and therefore approx. 30 ms may pass from when an input value changes to when the data read-out values change. The resolution of read-out value on fieldbus is in 10 W steps.

16-11 Power [hp]		
Range:	Function:	
0 hp* [0 - 1000 hp]	View the motor power in HP. The value shown is calculated on the basis of the actual motor voltage and motor current. The value is filtered, and therefore approximately 30 ms may pass from when an input value changes to when the data read-out values change.	

16-12 Motor Voltage		
Range:	Function:	
0 V* [0 - 6000 V]	View the motor voltage, a calculated value used for controlling the motor.	

16-13 Frequency		
Range:	Function:	
0 Hz* [0 - 6500 Hz]	View the motor frequency, without resonance dampening.	

16-14 Motor current		
Range:	Function:	
0 A* [0 - 1856 A]	View the motor current measured as a mean value, I_{RMS} . The value is filtered, and thus approximately 30 ms may pass from when an input value changes to when the data read-out values change.	

16-15 Frequency [%]		
Range:	Function:	
0 %* [-100 - 100 %]	View a two-byte word reporting the actual motor frequency (without resonance dampening) as a percentage (scale 0000-4000 Hex) of <i>4-19 Max Output Frequency</i> . Set <i>9-16 PCD Read Configuration</i> index 1 to send it with the Status Word instead of the MAV.	

3.13.1 16-1* Motor Status

16-10 Power [kW]		
Range:	Function:	
0 kW* [0 - 1000 kW]	Displays motor power in kW. The value shown is calculated on the basis of the actual motor voltage and motor current. The value is	

16-16 Torque [Nm]		
Range:	Function:	
0 Nm* [-3000 - 3000 Nm]	View the torque value with sign, applied to the motor shaft. Linearity is not exact between 110% motor current and torque in relation to the rated torque. Some motors supply more than 160% torque. Consequently, the min. value and the max. value will depend on the max. motor current as well as the motor used. The value is filtered, and thus approx. 1.3 s may pass from when an input changes value to when the data read-out values change.	

16-17 Speed [RPM]		
Range:	Function:	
0 RPM* [-30000 - 30000 RPM]	View the actual motor RPM.	

16-18 Motor Thermal		
Range:	Function:	
0 %* [0 - 100 %]	View the calculated thermal load on the motor. The cut-out limit is 100%. The basis for calculation is the ETR function selected in <i>1-90 Motor Thermal Protection</i> .	

16-22 Torque [%]		
Range:	Function:	
0 %* [-200 - 200 %]	This is a read out parameter only. Shows the actual torque yielded in percentage of the rated torque, based on the setting of the motor size and rated speed in <i>1-20 Motor Power [kW]</i> or <i>1-21 Motor Power [HP]</i> and <i>1-25 Motor Nominal Speed</i> . This is the value monitored by the <i>Broken Belt Function</i> set in parameter group 22-6*.	

3.13.2 16-3* Drive Status

16-30 DC Link Voltage		
Range:	Function:	
0 V* [0 - 10000 V]	View a measured value. The value is filtered with an 30 ms time constant.	

16-32 Brake Energy /s		
Range:	Function:	
0 kW* [0 - 675000 kW]	View the brake power transmitted to an external brake resistor, stated as an instantaneous value.	

16-33 Brake Energy /2 min		
Range:	Function:	
0 kW* [0 - 500 kW]	View the brake power transmitted to an external brake resistor. The mean power is calculated on an average basis for the most recent 120 s.	

16-34 Heatsink Temp.		
Range:	Function:	
0 °C* [0 - 255 °C]	View the frequency converter heatsink temperature. The cut-out limit is 90 ±5 °C, and the motor cuts back in at 60 ±5 °C.	

16-35 Inverter Thermal		
Range:	Function:	
0 %* [0 - 100 %]	View the percentage load on the inverter.	

16-36 Inv. Nom. Current		
Range:	Function:	
Size related* [0.01 - 10000 A]	View the inverter nominal current, which should match the nameplate data on the connected motor. The data are used for calculation of torque, motor protection, etc.	

16-37 Inv. Max. Current		
Range:	Function:	
Size related* [0.01 - 10000 A]	The current that FC 103 can deliver during 1 min./10 min. This value changes depending on whether it is a high overload or normal overload application. The data are used for calculation of torque, motor protection, etc.	

16-38 SL Controller State		
Range:	Function:	
0 * [0 - 100]	View the state of the event under execution by the SL controller.	

16-39 Control Card Temp.		
Range:	Function:	
0 °C* [0 - 100 °C]	View the temperature on the control card, stated in °C	

16-40 Logging Buffer Full		
Option:	Function:	
	View whether the logging buffer is full (see parameter group 15-1*). The logging buffer will never be full when <i>15-13 Logging Mode</i> is set to <i>[0] Log always</i> .	
[0] *	No	
[1]	Yes	

16-41 LCP Bottom Statusline		
Range:	Function:	
0 *	[0 - 0]	

3.13.3 16-5* Ref. & Feedb.

16-50 External Reference		
Range:	Function:	
0 * [-200 - 200]	View the total reference, the sum of digital, analog, preset, bus and freeze references, plus catch-up and slow-down.	

16-52 Feedback[Unit]		
Range:	Function:	
0 ProcessCtrlUnit*	[-999999.999 - 999999.999 ProcessCtrlUnit]	View value of resulting feedback value after processing of Feedback 1-3 (see 16-54 Feedback 1 [Unit], 16-55 Feedback 2 [Unit] and 16-56 Feedback 3 [Unit]) in the feedback manager. See parameter group 20-0* Feedback. The value is limited by settings in and . Units as set in 20-12 Reference/Feedback Unit.

16-53 Digi Pot Reference		
Range:	Function:	
0 * [-200 - 200]	View the contribution of the Digital Potentiometer to the actual reference.	

16-54 Feedback 1 [Unit]		
Range:	Function:	
0 ProcessCtrlUnit*	[-999999.999 - 999999.999 ProcessCtrlUnit]	View value of Feedback 1, see parameter group 20-0* Feedback. The value is limited by settings in 20-13 Minimum Reference/Feedb. and 20-14 Maximum Reference/Feedb.. Units as set in 20-12 Reference/Feedback Unit.

16-55 Feedback 2 [Unit]		
Range:	Function:	
0 ProcessCtrlUnit*	[-999999.999 - 999999.999 ProcessCtrlUnit]	View value of Feedback 2, see parameter group 20-0* Feedback. The value is limited by settings in 20-13 Minimum Reference/Feedb. and 20-14 Maximum Reference/Feedb.. Units as set in 20-12 Reference/Feedback Unit.

16-56 Feedback 3 [Unit]		
Range:	Function:	
0 ProcessCtrlUnit*	[-999999.999 - 999999.999 ProcessCtrlUnit]	View value of Feedback 3, see parameter group 20-0* Feedback. The value is limited by settings in 20-13 Minimum Reference/Feedb. and 20-14 Maximum Reference/Feedb.. Units as set in 20-12 Reference/Feedback Unit.

3.13.4 16-6* Inputs and Outputs

16-60 Digital Input		
Range:	Function:	
0 * [0 - 1023]	View the signal states from the active digital inputs. Example: Input 18 corresponds to bit no. 5, '0' = no signal, '1' = connected signal. Bit 6 works in the opposite way, on = '0', off = '1' (safe stop input).	
	Bit 0	Digital input term. 33
	Bit 1	Digital input term. 32
	Bit 2	Digital input term. 29
	Bit 3	Digital input term. 27
	Bit 4	Digital input term. 19
	Bit 5	Digital input term. 18
	Bit 6	Digital input term. 37
	Bit 7	Digital input GP I/O term. X30/4
	Bit 8	Digital input GP I/O term. X30/3
	Bit 9	Digital input GP I/O term. X30/2
	Bit 10-63	Reserved for future terminals

Table 3.20

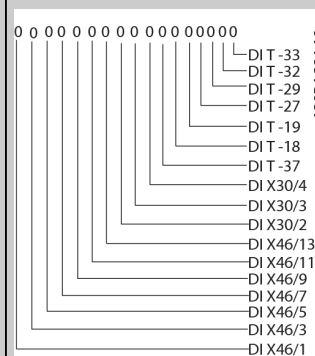

Illustration 3.38

16-61 Terminal 53 Switch Setting		
Option:	Function:	
		View the setting of input terminal 53. Current = 0; Voltage = 1.
[0]	Current	
[1]	Voltage	

16-62 Analog Input 53		
Range:	Function:	
0 *	[-20 - 20]	View the actual value at input 53.

16-63 Terminal 54 Switch Setting		
Option:	Function:	
		View the setting of input terminal 54. Current = 0; Voltage = 1.
[0]	Current	
[1]	Voltage	

16-64 Analog Input 54		
Range:	Function:	
0 *	[-20 - 20]	View the actual value at input 54.

16-65 Analog Output 42 [mA]		
Range:	Function:	
0 *	[0 - 30]	View the actual value at output 42 in mA. The value shown reflects the selection in 6-50 Terminal 42 Output.

16-66 Digital Output [bin]		
Range:	Function:	
0 *	[0 - 15]	View the binary value of all digital outputs.

16-67 Pulse Input #29 [Hz]		
Range:	Function:	
0 *	[0 - 130000]	View the actual frequency rate on terminal 29.

16-68 Pulse Input #33 [Hz]		
Range:	Function:	
0 *	[0 - 130000]	View the actual value of the frequency applied at terminal 33 as an impulse input.

16-69 Pulse Output #27 [Hz]		
Range:	Function:	
0 *	[0 - 40000]	View the actual value of impulses applied to terminal 27 in digital output mode.

16-70 Pulse Output #29 [Hz]		
Range:	Function:	
0 *	[0 - 40000]	View the actual value of pulses to terminal 29 in digital output mode.

16-71 Relay Output [bin]		
Range:	Function:	
0 *	[0 - 31]	View the settings of all relays.

Readout choice (Par. 16-71):
Relay output (bin):

130BA195.10

0 0 0 0 0 bin

OptionB card relay 09
OptionB card relay 08
OptionB card relay 07
Power card relay 02
Power card relay 01

Illustration 3.40

16-72 Counter A		
Range:	Function:	
0 *	[-2147483648 - 2147483647]	View the present value of Counter A. Counters are useful as comtor operands, see 13-10 Comparator Operand. The value can be reset or changed either via digital inputs (parameter group 5-1*) or by using an SLC action (13-52 SL Controller Action).

16-73 Counter B		
Range:	Function:	
0 *	[-2147483648 - 2147483647]	View the present value of Counter B. Counters are useful as comtor operands (13-10 Comparator Operand). The value can be reset or changed either via digital inputs (parameter group 5-1*) or by using an SLC action (13-52 SL Controller Action).

16-75 Analog In X30/11		
Range:	Function:	
0 *	[-20 - 20]	View the actual value at input X30/11 of MCB 101.

16-76 Analog In X30/12		
Range:	Function:	
0 *	[-20 - 20]	View the actual value at input X30/12 of MCB 101.

16-77 Analog Out X30/8 [mA]		
Range:	Function:	
0 *	[0 - 30]	View the actual value at input X30/8 in mA.

3.13.5 16-8* Fieldbus & FC Port

Parameters for reporting the BUS references and control words.

16-80 Fieldbus CTW 1		
Range:	Function:	
0 * [0 - 65535]	View the two-byte Control word (CTW) received from the Bus-Master. Interpretation of the Control word depends on the Fieldbus option installed and the Control word profile selected in <i>8-10 Control Profile</i> . For more information, refer to the relevant Fieldbus manual.	

16-82 Fieldbus REF 1		
Range:	Function:	
0 * [-200 - 200]	View the two-byte word sent with the control word from the Bus-Master to set the reference value. For more information, refer to the relevant fieldbus manual.	

16-84 Comm. Option STW		
Range:	Function:	
0 * [0 - 65535]	View the extended Fieldbus comm. option status word. For more information, refer to the relevant Fieldbus manual.	

16-85 FC Port CTW 1		
Range:	Function:	
0 * [0 - 65535]	View the two-byte Control word (CTW) received from the Bus-Master. Interpretation of the control word depends on the Fieldbus option installed and the Control word profile selected in <i>8-10 Control Profile</i> .	

16-86 FC Port REF 1		
Range:	Function:	
0 * [-200 - 200]	View the two-byte Status word (STW) sent to the Bus-Master. Interpretation of the Status word depends on the fieldbus option installed and the Control word profile selected in <i>8-10 Control Profile</i> .	

3.13.6 16-9* Diagnosis Read-Outs

16-90 Alarm Word		
Range:	Function:	
0 * [0 - 4294967295]	View the alarm word sent via the serial communication port in hex code.	

16-91 Alarm Word 2		
Range:	Function:	
0 * [0 - 4294967295]	View the alarm word 2 sent via the serial communication port in hex code.	

16-92 Warning Word		
Range:	Function:	
0 * [0 - 4294967295]	View the warning word sent via the serial communication port in hex code.	

16-93 Warning Word 2		
Range:	Function:	
0 * [0 - 4294967295]	View the warning word 2 sent via the serial communication port in hex code.	

16-94 Ext. Status Word		
Range:	Function:	
0 * [0 - 4294967295]	Returns the extended status word sent via the serial communication port in hex code.	

16-95 Ext. Status Word 2		
Range:	Function:	
0 * [0 - 4294967295]	Returns the extended warning word 2 sent via the serial communication port in hex code.	

16-96 Maintenance Word		
Range:	Function:	
0 * [0 - 4294967295]	Readout of the Preventive Maintenance Word. The bits reflect the status for the programmed Preventive Maintenance Events in parameter group 23-1*. 13 bits represent combinations of all the possible items: <ul style="list-style-type: none"> • Bit 0: Motor bearings • Bit 1: Pump bearings • Bit 2: Fan bearings • Bit 3: Valve • Bit 4: Pressure transmitter • Bit 5: Flow transmitter • Bit 6: Temperature transmitter • Bit 7: Pump seals • Bit 8: Fan belt • Bit 9: Filter • Bit 10: Drive cooling fan • Bit 11: Drive system health check • Bit 12: Warranty • Bit 13: Maintenance Text 0 • Bit 14: Maintenance Text 1 • Bit 15: Maintenance Text 2 • Bit 16: Maintenance Text 3 • Bit 17: Maintenance Text 4 	

16-96 Maintenance Word					
Range:	Function:				
	Position 4 →	Valve	Fan bearings	Pump bearings	Motor bearings
	Position 3 →	Pump seals	Temperature transmitter	Flow transmitter	Pressure transmitter
	Position 2 →	Drive system health check	Drive cooling fan	Filter	Fan belt
	Position 1 →				Warranty
	0 _{hex}	-	-	-	-
	1 _{hex}	-	-	-	+
	2 _{hex}	-	-	+	-
	3 _{hex}	-	-	+	+
	4 _{hex}	-	+	-	-
	5 _{hex}	-	+	-	+
	6 _{hex}	-	+	+	-
	7 _{hex}	-	+	+	+
	8 _{hex}	+	-	-	-
	9 _{hex}	+	-	-	+
	A _{hex}	+	-	+	-
	B _{hex}	+	-	+	+
	C _{hex}	+	+	-	-
	D _{hex}	+	+	-	+
	E _{hex}	+	+	+	-
	F _{hex}	+	+	+	+

Table 3.23

Example:
The Preventive Maintenance Word shows 040A_{hex}.

Position	1	2	3	4
hex-value	0	4	0	A

Table 3.24

The first digit 0 indicates that no items from the fourth row requires maintenance
 The second digit 4 refers to the third row indicating that the Drive Cooling Fan requires maintenance
 The third digit 0 indicates that no items from the second row requires maintenance
 The fourth digit A refers to the top row indicating that the Valve and the Pump Bearings require maintenance

3.14 Main Menu - Data Readouts 2 - Group 18

3.14.1 18-0* Maintenance Log

This group contains the last 10 Preventive Maintenance events. Maintenance Log 0 is the latest and Maintenance Log 9 the oldest.

By selecting one of the logs and pressing [OK], the Maintenance Item, Action and time of the occurrence can be found in *18-00 Maintenance Log: Item* – *18-03 Maintenance Log: Date and Time*.

The Alarm log key allows access to both Alarm log and Maintenance log.

18-00 Maintenance Log: Item		
Array [10]. Array parameter; Error code 0-9: The meaning of the error code can be found in the Troubleshooting section of the Design Guide.		
Range:	Function:	
0 *	[0 - 255]	Locate the meaning of the Maintenance Item in the description of <i>23-10 Maintenance Item</i> .

18-01 Maintenance Log: Action		
Array [10]. Array parameter; Error code 0-9: The meaning of the error code can be found in <i>Troubleshooting</i> in the Design Guide.		
Range:	Function:	
0 *	[0 - 255]	Locate the meaning of the Maintenance Item in the description of <i>23-11 Maintenance Action</i>

18-02 Maintenance Log: Time		
Array [10]. Array parameter; Time 0-9: This parameter shows at which time the logged event occurred. Time is measured in seconds since start of the frequency converter.		
Range:	Function:	
0 s*	[0 - 2147483647 s]	Shows when the logged event occurred. Time is measured in seconds since last power-up.

18-03 Maintenance Log: Date and Time		
Array [10]		
Range:	Function:	
Size related*	[0 - 0]	Shows when the logged event occurred.
NOTE This requires that the date and time is programmed in <i>0-70 Set Date and Time</i> .		

18-03 Maintenance Log: Date and Time		
Array [10]		
Range:	Function:	
	Date format depends on the setting in <i>0-71 Date Format</i> , while the time format depends on the setting in <i>0-72 Time Format</i> .	
NOTE The frequency converter has no back up of the clock function and the set date/time will reset to default (2000-01-01 00:00) after a power down unless a Real Time Clock module with back up is installed. In <i>0-79 Clock Fault</i> it is possible to program for a Warning in case clock has not been set properly, e.g. after a power down. Incorrect setting of the clock will affect the time stamps for the Maintenance Events.		

NOTE

When mounting an Analog I/O MCB 109 option card, a battery back-up of date and time is included.

3.14.2 18-1* Fire Mode Log

The log covers the latest 10 faults which have been suppressed by the Fire Mode function. See parameter group *24-0**, *Fire Mode*. The log can be viewed either via the below parameters or by pressing the Alarm Log button on the LCP and select Fire Mode Log. It is not possible to reset the Fire Mode Log.

18-10 FireMode Log:Event		
Range:	Function:	
0 *	[0 - 255]	This parameter contains an array with 10 elements. The number read represent an error code, which corresponds to a specific alarm. This can be found in the Troubleshooting section in the Design Guide.

18-11 Fire Mode Log: Time		
Range:	Function:	
0 s*	[0 - 2147483647 s]	This parameter contains an array with 10 elements. The parameter shows at which time the logged event occurred. Time is measured in seconds since the first start of the motor.

18-12 Fire Mode Log: Date and Time		
Range:		Function:
Size related*	[0 - 0]	This parameter contains an array with 10 elements. The parameter shows at which date and time the logged event occurred. The function relies on that the actual date and time has been set in <i>0-70 Set Date and Time</i> . Note: There is no build in battery back up of the clock. An external back up must be used, eg the one in the MCB 109 Analog I/O option card. See Clock Settings, parameter group 0-7*.

18-35 Analog Out X42/11 [V]		
Range:		Function:
0 *	[0 - 30]	Read out of the value of the signal applied to terminal X42/11 on the Analog I/O Card. The value shown reflects the selection in <i>26-60 Terminal X42/11 Output</i> .

3

3.14.3 18-3* Analog I/O

Parameters for reporting the digital and analog I/O ports.

18-30 Analog Input X42/1		
Range:		Function:
0 *	[-20 - 20]	Read out of the value of the signal applied to terminal X42/1 on the Analog I/O Card. The units of the value shown in the LCP will correspond to the mode selected in <i>26-00 Terminal X42/1 Mode</i> .

18-31 Analog Input X42/3		
Range:		Function:
0 *	[-20 - 20]	Read out of the value of the signal applied to terminal X42/3 on the Analog I/O Card. The units of the value shown in the LCP will correspond to the mode selected in <i>26-01 Terminal X42/3 Mode</i> .

18-32 Analog Input X42/5		
Range:		Function:
0 *	[-20 - 20]	Read out of the value of the signal applied to terminal X42/5 on the Analog I/O Card. The units of the value shown in the LCP will correspond to the mode selected in <i>26-02 Terminal X42/5 Mode</i> .

18-33 Analog Out X42/7 [V]		
Range:		Function:
0 *	[0 - 30]	Read out of the value of the signal applied to terminal X42/7 on the Analog I/O Card. The value shown reflects the selection in <i>26-40 Terminal X42/7 Output</i> .

18-34 Analog Out X42/9 [V]		
Range:		Function:
0 *	[0 - 30]	Read out of the value of the signal applied to terminal X42/9 on the Analog I/O Card. The value shown reflects the selection in <i>26-50 Terminal X42/9 Output</i> .

3.15 Main Menu - FC Closed Loop - Group 20

This parameter group is used for configuring the closed loop PID Controller, that controls the output frequency of the frequency converter.

Loop Mode or Open Loop Mode, the feedback signals can also be shown on the frequency converter's display, be used to control a frequency converter analog output, and be transmitted over various serial communication protocols.

3

3.15.1 20-0* Feedback

This parameter group is used to configure the feedback signal for the frequency converter's closed loop PID Controller. Whether the frequency converter is in Closed

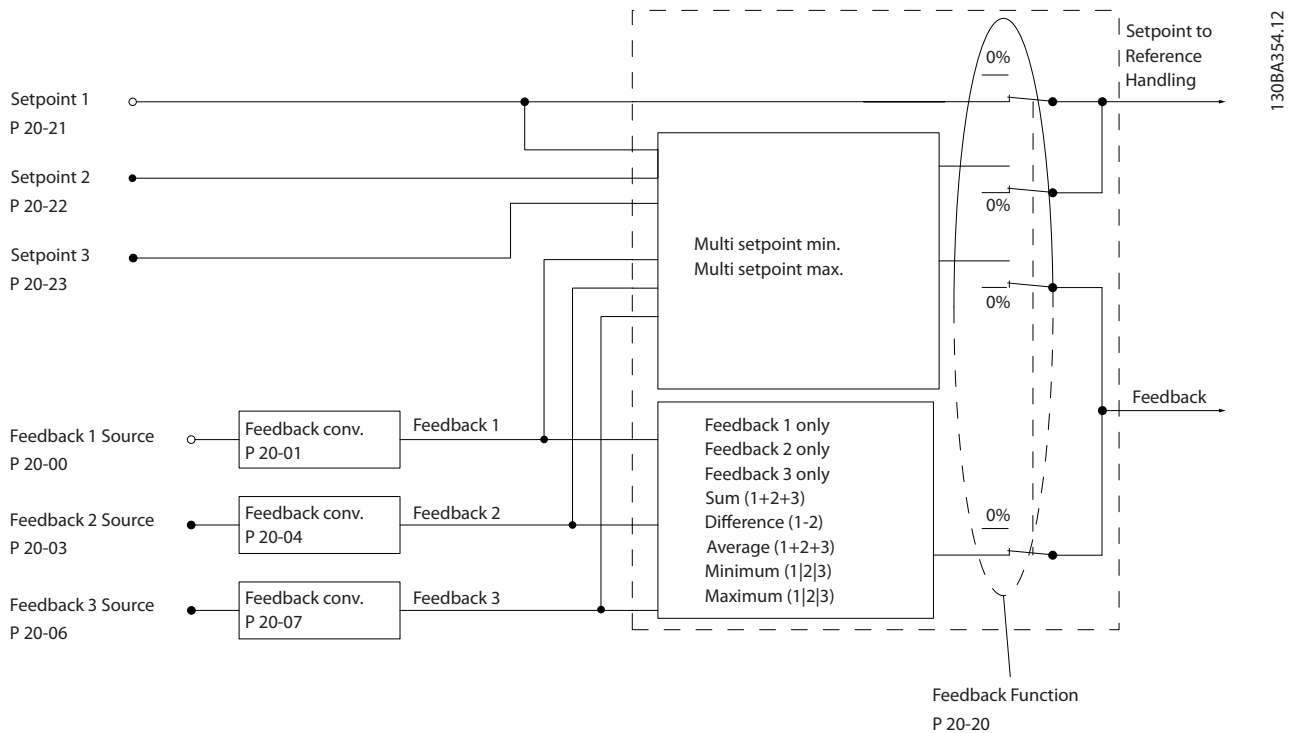

Illustration 3.41

20-00 Feedback 1 Source	
Option:	Function:
[0]	No function
[1]	Analog Input 53
[2] *	Analog Input 54
[3]	Pulse input 29
[4]	Pulse input 33

20-00 Feedback 1 Source	
Option:	Function:
[7]	Analog Input X30/11
[8]	Analog Input X30/12
[9]	Analog Input X42/1
[10]	Analog Input X42/3
[11]	Analog Input X42/5
[100]	Bus Feedback 1
[101]	Bus Feedback 2
[102]	Bus feedback 3

NOTE

If a feedback is not used, its source must be set to [0] No Function. 20-20 Feedback Function determines how the three possible feedbacks will be used by the PID Controller.

20-01 Feedback 1 Conversion

This parameter allows a conversion function to be applied to Feedback 1.

Option: **Function:**

[0]	Linear	Linear [0] has no effect on the feedback.
[1]	Square root	Square root [1] is commonly used when a pressure sensor is used to provide flow feedback (($flow \propto \sqrt{pressure}$)).
[2] *	Pressure to temperature	Pressure to temperature [2] is used in compressor applications to provide temperature feedback using a pressure sensor. The temperature of the refrigerant is calculated using the following formula: $Temperature = \frac{A2}{(ln(Pe + 1) - A1)} - A3$, where A1, A2 and A3 are refrigerant-specific constants. The refrigerant must be selected in 20-30 Refrigerant. 20-31 User Defined Refrigerant A1 through 20-33 User Defined Refrigerant A3 allow the values of A1, A2 and A3 to be entered for a refrigerant that is not listed in 20-30 Refrigerant.

20-02 Feedback 1 Source Unit

This parameter determines the unit that is used for this Feedback Source, prior to applying the feedback conversion of 20-01 Feedback 1 Conversion. This unit is not used by the PID Controller. It is used only for display and monitoring purposes.

Option: **Function:**

[70]	mbar	
[71] *	bar	
[72]	Pa	
[73]	kPa	
[74]	m WG	
[170]	psi	
[171]	lb/in ²	
[172]	in WG	
[173]	ft WG	

NOTE

This parameter is only available when using Pressure to Temperature Feedback Conversion.

20-03 Feedback 2 Source

Option: **Function:**
See 20-00 Feedback 1 Source for details.

[0] *	No function	
[1]	Analog Input 53	

20-03 Feedback 2 Source

Option:	Function:
[2]	Analog Input 54
[3]	Pulse input 29
[4]	Pulse input 33
[7]	Analog Input X30/11
[8]	Analog Input X30/12
[9]	Analog Input X42/1
[10]	Analog Input X42/3
[11]	Analog Input X42/5
[100]	Bus Feedback 1
[101]	Bus Feedback 2
[102]	Bus feedback 3

20-04 Feedback 2 Conversion

Option:	Function:
	See 20-01 Feedback 1 Conversion for details.
[0] *	Linear
[1]	Square root
[2]	Pressure to temperature

20-05 Feedback 2 Source Unit

Option:	Function:
	See 20-02 Feedback 1 Source Unit for details.

20-06 Feedback 3 Source

Option:	Function:
	See 20-00 Feedback 1 Source for details.
[0] *	No function
[1]	Analog Input 53
[2]	Analog Input 54
[3]	Pulse input 29
[4]	Pulse input 33
[7]	Analog Input X30/11
[8]	Analog Input X30/12
[9]	Analog Input X42/1
[10]	Analog Input X42/3
[11]	Analog Input X42/5
[100]	Bus Feedback 1
[101]	Bus Feedback 2
[102]	Bus feedback 3

20-07 Feedback 3 Conversion

Option:	Function:
	See 20-01 Feedback 1 Conversion for details.
[0] *	Linear
[1]	Square root
[2]	Pressure to temperature

20-20 Feedback Function		
Option:	Function:	
	<p>NOTE</p> <p>If only two feedback signals are used, the feedback that is not to be used must be set to <i>No Function</i> in <i>20-00 Feedback 1 Source</i>, <i>20-03 Feedback 2 Source</i> or <i>20-06 Feedback 3 Source</i>. Note that each setpoint reference will be the sum of its respective parameter value (<i>20-21 Setpoint 1</i>, <i>20-22 Setpoint 2</i> and <i>20-23 Setpoint 3</i>) and any other references that are enabled (see parameter group 3-1*).</p>	
[6]	Multi Setpoint Max	<p>[6] <i>Multi-setpoint maximum</i> sets up the PID Controller to calculate the difference between Feedback 1 and Setpoint 1, Feedback 2 and Setpoint 2, and Feedback 3 and Setpoint 3. It will use the feedback/setpoint pair in which the feedback is farthest above its corresponding setpoint reference. If all feedback signals are below their corresponding setpoints, the PID Controller will use the feedback/setpoint pair in which the difference between the feedback and the setpoint reference is the least.</p> <p>NOTE</p> <p>If only two feedback signals are used, the feedback that is not to be used must be set to <i>No Function</i> in <i>20-00 Feedback 1 Source</i>, <i>20-03 Feedback 2 Source</i> or <i>20-06 Feedback 3 Source</i>. Note that each setpoint reference will be the sum of its respective parameter value (<i>20-21 Setpoint 1</i>, <i>20-22 Setpoint 2</i> and <i>20-23 Setpoint 3</i>) and any other references that are enabled (see parameter group 3-1*).</p>

NOTE

Any unused feedback must be set to “No function” in its Feedback Source parameter: *20-00 Feedback 1 Source*, *20-03 Feedback 2 Source* or *20-06 Feedback 3 Source*.

The feedback resulting from the function selected in *20-20 Feedback Function* will be used by the PID Controller to control the output frequency of the frequency converter. This feedback can also be shown on the frequency converter’s display, be used to control a frequency converter’s analog output, and be transmitted over various serial communication protocols.

20-21 Setpoint 1		
Range:	Function:	
0 ProcessCtrlUnit*	[-999999.999 - 999999.999 ProcessCtrlUnit]	Setpoint 1 is used in Closed Loop Mode to enter a setpoint reference that is

20-21 Setpoint 1		
Range:	Function:	
		<p>used by the frequency converter’s PID Controller. See the description of <i>20-20 Feedback Function</i>.</p> <p>NOTE</p> <p>Setpoint reference entered here is added to any other references that are enabled (see parameter group 3-1*).</p>

20-22 Setpoint 2		
Range:	Function:	
0 ProcessCtrlUnit*	[-999999.999 - 999999.999 ProcessCtrlUnit]	<p>Setpoint 2 is used in Closed Loop Mode to enter a setpoint reference that may be used by the frequency converter’s PID Controller. See the description of <i>Feedback Function</i>, <i>20-20 Feedback Function</i>.</p>

NOTE

The set-point reference entered here is added to any other references that are enabled (see parameter group 3-1*).

20-23 Setpoint 3		
Range:	Function:	
0 ProcessCtrlUnit*	[-999999.999 - 999999.999 ProcessCtrlUnit]	<p>Setpoint 3 is used in Closed Loop Mode to enter a setpoint reference that may be used by the frequency converter’s PID Controller. See the description of <i>20-20 Feedback Function</i>.</p> <p>NOTE</p> <p>The setpoint reference entered here is added to any other references that are enabled (see parameter group 3-1*).</p>

3.15.3 20-3* Feedback Adv. Conversion

In air conditioning compressor applications it is often useful to control the system based on the temperature of the refrigerant. However, it is generally more convenient to directly measure its pressure. This parameter group allows the frequency converter’s PID Controller to convert

refrigerant pressure measurements into temperature values.

20-30 Refrigerant

Select the refrigerant used in the compressor application. This parameter must be specified correctly for the pressure to temperature conversion to be accurate. If the refrigerant used is not listed in choices [0] through [6], select *User defined* [7]. Then, use 20-31 *User Defined Refrigerant A1*, 20-32 *User Defined Refrigerant A2* and 20-33 *User Defined Refrigerant A3* to provide A1, A2 and A3 for the equation below:

$$\text{Temperature} = \frac{A2}{(\ln(Pe + 1) - A1)} - A3$$

Option:

Function:

Option	Function
[0] *	R user
[1]	R12
[2]	R22
[3]	R134a
[4]	R502
[5]	R717
[6]	R13
[7]	R13b1
[8]	R23
[9]	R500
[10]	R503
[11]	R114
[12]	R142b
[14]	R32
[15]	R227
[16]	R401A
[17]	R507
[18]	R402A
[19]	R404A
[20]	R407C
[21]	R407A
[22]	R407B
[23]	R410A
[24]	R170
[25]	R290
[26]	R600
[27]	R600a
[28]	R744
[29]	R1270
[30]	R417A
[31]	Isceon 29

20-31 User Defined Refrigerant A1

Range:

Function:

10 *	[8 - 12]	Use this parameter to enter the value of coefficient A1 when 20-30 Refrigerant is set to <i>User defined</i> [7].
------	-----------	---

20-32 User Defined Refrigerant A2

Range:

Function:

-2250 *	[-3000 - -1500]	Use this parameter to enter the value of coefficient A2 when 20-30 Refrigerant is set to <i>User defined</i> [7].
---------	---------------------	---

20-33 User Defined Refrigerant A3

Range:

Function:

250 *	[200 - 300]	Use this parameter to enter the value of coefficient A3 when 20-30 Refrigerant is set to <i>User defined</i> [7].
-------	--------------	---

20-35 Fan 1 Area [in2]

Range:

Function:

		Used for setting the area of the air ducts in connection with feedback conversion pressure/velocity to flow. The unit (in ²) is determined by the setting of 0-03 <i>Regional Settings</i> . Fan 1 is used with feedback 1. In case of flow difference control, set 20-20 <i>Feedback Function</i> to [1] Difference, if flow fan 1 – flow fan 2 is to be controlled.
750 in2*	[0 - 15000 in2]	

20-36 Fan 2 Area [m2]

Range:

Function:

		Used for setting the area of the air ducts in connection with feedback conversion pressure/velocity to flow. The unit (m ²) is determined by the setting of 0-03 <i>Regional Settings</i> . Fan 2 is used with feedback 2. In case of flow difference control, set 20-20 <i>Feedback Function</i> to [1] Difference, if flow fan 1 – flow fan 2 is to be controlled.
0.500 m2*	[0.000 - 10.000 m2]	

20-37 Fan 2 Area [in2]

Range:

Function:

		Used for setting the area of the air ducts in connection with feedback conversion pressure/velocity to flow. The unit (in ²) is determined by the setting of 0-03 <i>Regional Settings</i> . Fan 2 is used with feedback 2. In case of flow difference control, set 20-20 <i>Feedback Function</i> to [1] Difference, if flow fan 1 – flow fan 2 is to be controlled.
750 in2*	[0 - 15000 in2]	

20-38 Air Density Factor [%]		
Range:	Function:	
100 %*	[50 - 150 %]	Set the air density factor for conversion from pressure to flow in % relative to the air density at sea level at 20 °C (100% ~ 1,2 kg/m ³).

3.15.4 20-6* Sensorless

Parameters for Sensorless. See also *20-00 Feedback 1 Source*, *18-50 Sensorless Readout [unit]*, *16-26 Power Filtered [kW]* and *16-27 Power Filtered [hp]*.

NOTE

Sensorless unit and Sensorless Information requires set up by with sensorless specific plug in.

20-60 Sensorless Unit		
Option:	Function:	
[20]	l/s	
[21]	l/min	
[22]	l/h	
[23]	m ³ /s	
[24]	m ³ /min	
[25]	m ³ /h	
[70]	mbar	
[71]	bar	
[72]	Pa	
[73]	kPa	
[74]	m WG	
[75]	mm Hg	
[120]	GPM	
[121]	gal/s	
[122]	gal/min	
[123]	gal/h	
[124]	CFM	
[125]	ft ³ /s	
[126]	ft ³ /min	
[127]	ft ³ /h	
[170]	psi	
[171]	lb/in ²	
[172]	in WG	
[173]	ft WG	
[174]	in Hg	

3.15.5 20-7* PID autotuning

The frequency converter PID Closed Loop controller (parameter group 20-**, FC Drive Closed Loop) can be auto-tuned, simplifying and saving time during commissioning, whilst ensuring accurate PID control adjustment. To use auto-tuning it is necessary for the frequency

converter to be configured for closed loop in *1-00 Configuration Mode*.

A Graphical Local Control Panel (LCP) must be used in order to react on messages during the auto-tuning sequence.

Enabling *20-79 PID Autotuning*, puts the frequency converter into auto-tuning mode. The LCP then directs the user with on-screen instructions.

The fan/pump is started by pressing [Auto On] and applying a start signal. The speed is adjusted manually by pressing [▲] or [▼] to a level where the feedback is around the system set-point.

NOTE

It is not possible to run the motor at maximum or minimum speed, when manually adjusting the motor speed due to the need of giving the motor a step in the speed during auto-tuning.

PID auto-tuning functions by introducing step changes whilst operating at a steady state and then monitoring the feedback. From the feedback response, the required values for *20-93 PID Proportional Gain* and *20-94 PID Integral Time* are calculated. *20-95 PID Differentiation Time* is set to value 0 (zero). *20-81 PID Normal/ Inverse Control* is determined during tuning process.

These calculated values are presented on the LCP and the user can decide whether to accept or reject them. Once accepted, the values are written to the relevant parameters and auto-tuning mode is disabled in *20-79 PID Autotuning*. Depending on the system being controlled the time required to carry out auto-tuning could be several minutes. It is advised to set the ramp times in *3-41 Ramp 1 Ramp Up Time*, *3-42 Ramp 1 Ramp Down Time* or *3-51 Ramp 2 Ramp Up Time* and *3-52 Ramp 2 Ramp Down Time* according to the load inertia before carrying out PID autotuning. If PID autotuning is carried out with slow ramp times, the auto-tuned parameters will typically result in very slow control. Excessive feedback sensor noise should be removed using the input filter (parameter groups 6-**, 5-5* and 26-**, Terminal 53/54 Filter Time Constant/Pulse Filter Time Constant #29/33) before activating PID autotuning. In order to obtain the most accurate controller parameters, it is advised to carry out PID autotuning, when the application is running in typical operation, i.e. with a typical load.

20-70 Closed Loop Type		
Option:	Function:	
		This parameter defines the application response. The default mode should be sufficient for most applications. If the application response speed is known, it can be selected here. This will decrease the time needed for carrying out PID autotuning. The setting has no impact on the value of the tuned parameters and is used only for the autotuning sequence.
[0] *	Auto	
[1]	Fast Pressure	
[2]	Slow Pressure	
[3]	Fast Temperature	
[4]	Slow Temperature	

20-71 PID Performance		
Option:	Function:	
[0] *	Normal	Normal setting of this parameter will be suitable for pressure control in fan systems.
[1]	Fast	Fast setting would generally be used in pumping systems, where a faster control response is desirable.

20-72 PID Output Change		
Range:	Function:	
0.10 *	[0.01 - 0.50]	This parameter sets the magnitude of step change during autotuning. The value is a percentage of full speed. I.e. if maximum output frequency in 4-13 Motor Speed High Limit [RPM]/4-14 Motor Speed High Limit [Hz] is set to 50 Hz, 0.10 is 10% of 50 Hz, which is 5 Hz. This parameter should be set to a value resulting in feedback changes of between 10% and 20% for best tuning accuracy.

20-73 Minimum Feedback Level		
Range:	Function:	
-999999 ProcessCtrlUnit*	[-999999.999 - par. 20-74 ProcessCtrlUnit]	The minimum allowable feedback level should be entered here in User units as defined in 20-12 Reference/Feedback Unit. If the level falls below 20-73 Minimum Feedback Level, autotuning is aborted and an error message appears in the LCP.

20-74 Maximum Feedback Level		
Range:	Function:	
999999 ProcessCtrlUnit*	[par. 20-73 - 999999.999 ProcessCtrlUnit]	The maximum allowable feedback level should be entered here in User units as defined in 20-12 Reference/Feedback Unit. If the level rises above 20-74 Maximum Feedback Level, autotuning is aborted and an error message appears in the LCP.

20-79 PID Autotuning		
Option:	Function:	
		This parameter starts the PID autotuning sequence. Once the autotuning has successfully completed and the settings have been accepted or rejected by the user, by pressing [OK] or [Cancel] at the end of tuning, this parameter is reset to [0] Disabled.
[0] *	Disabled	
[1]	Enabled	

3.15.6 20-8* PID Basic Settings

This parameter group is used to configure the basic operation of the frequency converter's PID Controller, including how it responds to a feedback that is above or below the setpoint, the speed at which it first starts functioning, and when it will indicate that the system has reached the setpoint.

20-81 PID Normal/Inverse Control		
Option:	Function:	
[0]	Normal	<i>Normal</i> [0] causes the frequency converter's output frequency to decrease when the feedback is greater than the setpoint reference. This is common for pressure-controlled supply fan and pump applications.
[1] *	Inverse	<i>Inverse</i> [1] causes the frequency converter's output frequency to increase when the feedback is greater than the setpoint reference. This is common for temperature-controlled cooling applications, such as cooling towers.

20-82 PID Start Speed [RPM]		
Range:		Function:
Size related*	[0 - par. 4-13 RPM]	When the frequency converter is first started, it initially ramps up to this output speed in Open Loop Mode, following the active Ramp Up Time. When the output speed programmed here is reached, the frequency converter will automatically switch to Closed Loop Mode and the PID Controller will begin to function. This is useful in applications in which the driven load must first quickly accelerate to a minimum speed when it is started. NOTE This parameter will only be visible if 0-02 Motor Speed Unit is set to [0] RPM.

20-83 PID Start Speed [Hz]		
Range:		Function:
Size related*	[0 - par. 4-14 Hz]	When the frequency converter is first started, it initially ramps up to this output frequency in Open Loop Mode, following the active Ramp Up Time. When the output frequency programmed here is reached, the frequency converter will automatically switch to Closed Loop Mode and the PID Controller will begin to function. This is useful in applications in which the driven load must first quickly accelerate to a minimum speed when it is started. NOTE This parameter will only be visible if 0-02 Motor Speed Unit is set to [1] Hz.

20-84 On Reference Bandwidth		
Range:		Function:
5 %*	[0 - 200 %]	When the difference between the feedback and the setpoint reference is less than the value of this parameter, the frequency converter's display will show "Run on Reference". This status can be communicated externally by programming the function of a digital output for [8] <i>Run on Reference/No Warning</i> . In addition, for serial communications, the On Reference status bit of the frequency converter's Status Word will be high (1). The <i>On Reference Bandwidth</i> is calculated as a percentage of the setpoint reference.

3.15.7 20-9* PID Controller

This group provides the ability to manually adjust this PID Controller. By adjusting the PID Controller parameters the control performance may be improved. See section **PID** in the *VLT Refrigeration Drive FC 103 Design Guide* for guidelines on adjusting the PID Controller parameters.

20-91 PID Anti Windup		
Option:		Function:
[0]	Off	[0] <i>Off</i> The integrator will continue to change value also after output has reached one of the extremes. This can afterwards cause a delay of change of the output of the controller.
[1] *	On	[1] <i>On</i> The integrator will be locked if the output of the built in PID controller has reached one of the extremes (min or max value) and therefore not able to add further change to the value of the process parameter controlled. This allows the controller to respond more quickly when it again can control the system.

20-93 PID Proportional Gain		
Range:		Function:
0.50 *	[0 - 10]	The proportional gain indicates the number of times the error between the set point and the feedback signal is to be applied.

If (Error x Gain) jumps with a value equal to what is set in *20-14 Maximum Reference/Feedb.* the PID controller will try to change the output speed equal to what is set in *4-13 Motor Speed High Limit [RPM]/4-14 Motor Speed High Limit [Hz]* but in practice of course limited by this setting. The proportional band (error causing output to change from 0-100%) can be calculated by means of the formula

$$\left(\frac{1}{\text{Proportional Gain}} \right) \times (\text{Max Reference})$$

NOTE

Always set the desired for *20-14 Maximum Reference/Feedb.* before setting the values for the PID controller in parameter group 20-9*.

20-94 PID Integral Time		
Range:	Function:	
30 s*	[0.01 - 10000 s]	<p>Over time, the integrator accumulates a contribution to the output from the PID controller as long as there is a deviation between the Reference/Setpoint and feedback signals. The contribution is proportional to the size of the deviation. This ensures that the deviation (error) approaches zero.</p> <p>Quick response on any deviation is obtained when the integral time is set to a low value. Setting it too low, however, may cause the control to become unstable.</p> <p>The value set, is the time needed for the integrator to add the same contribution as the proportional for a certain deviation.</p> <p>If the value is set to 10,000, the controller will act as a pure proportional controller with a P-band based on the value set in <i>20-93 PID Proportional Gain</i>. When no deviation is present, the output from the proportional controller will be 0.</p>

20-95 PID Differentiation Time		
Range:	Function:	
0.0 s*	[0.00 = Off - 10.00 s]	<p>The differentiator monitors the rate of change of the feedback. If the feedback is changing quickly, it will adjust the output of the PID Controller to reduce the rate of change of the feedback. Quick PID Controller response is obtained when this value is large. However, if too large of a value is used, the frequency converter's output frequency may become unstable.</p> <p>Differentiation time is useful in situations where extremely fast frequency converter response and precise speed control are required. It can be difficult to adjust this for proper system control. Differentiation time is not commonly used in VLT Refrigeration Drive applications. Therefore, it is generally best to leave this parameter at 0 or OFF.</p>

20-96 PID Diff. Gain Limit		
Range:	Function:	
5 *	[1 - 50]	<p>The differential function of a PID Controller responds to the rate of change of the feedback. As a result, an abrupt change in the feedback can cause the differential function to make a very large change in the PID Controller's output. This parameter limits the maximum effect that the PID Controller's differential function can produce. A smaller value reduces the maximum effect of the PID Controller's differential function.</p> <p>This parameter is only active when <i>20-95 PID Differentiation Time</i> is not set to OFF (0 s).</p>

3.16 Main Menu - Extended Closed Loop - Group 21

3.16.1 21-** Ext. Closed Loop

The FC 103 offers 3 Extended Closed Loop PID controllers in addition to the PID Controller. These can be configured independently to control either external actuators (valves, dampers etc.) or be used together with the internal PID Controller to improve the dynamic responses to setpoint changes or load disturbances.

The Extended Closed Loop PID controllers may be interconnected or connected to the PID Closed Loop controller to form a dual loop configuration.

In order to control a modulating device (e.g. a valve motor), this device must be a positioning servo motor with built-in electronics accepting either a 0-10 V (signal from Analog I/O card MCB 109) or a 0/4-20 mA (signal from Control Card and/or General Purpose I/O card MCB 101) control signal.

The output function can be programmed in the following parameters:

- Control Card, terminal 42: *6-50 Terminal 42 Output* (setting [113]...[115] or [149]...[151], Ext. Closed Loop 1/2/3
- General Purpose I/O card MCB 101, terminal X30/8: *6-60 Terminal X30/8 Output*, (setting [113]...[115] or [149]...[151], Ext. Closed Loop 1/2/3
- Analog I/O card MCB 109, terminal X42/7...11: *26-40 Terminal X42/7 Output/26-50 Terminal X42/9 Output/26-60 Terminal X42/11 Output* (setting [113]...[115], Ext. Closed Loop 1/2/3

General Purpose I/O card and Analog I/O card are optional cards.

3.16.2 21-0* Extended CL autotuning

The extended PID Closed Loop PID controllers can each be auto-tuned, simplifying and saving time during commissioning, whilst ensuring accurate PID control adjustment.

To use PID autotuning it is necessary for the relevant Extended PID controller to have been configured for the application.

A graphical Local Control Panel (LCP) must be used in order to react on messages during the autotuning sequence.

Enabling autotuning *21-09 PID Autotuning* puts the relevant PID controller into PID autotuning mode. The LCP then directs the user with on-screen instructions.

PID autotuning functions by introducing step changes and then monitoring the feedback. From the feedback response, the required values for PID Proportional Gain, *21-21 Ext. 1 Proportional Gain* for EXT CL 1, *21-41 Ext. 2 Proportional Gain* for EXT CL 2 and *21-61 Ext. 3 Proportional Gain* for EXT CL 3 and Integral Time, *21-22 Ext. 1 Integral Time* for EXT CL 1, *21-42 Ext. 2 Integral Time* for EXT CL 2 and *21-62 Ext. 3 Integral Time* for EXT CL 3 are calculated. PID Differentiation Time, *21-23 Ext. 1 Differentiation Time* for EXT CL 1, *21-43 Ext. 2 Differentiation Time* for EXT CL 2 and *21-63 Ext. 3 Differentiation Time* for EXT CL 3 are set to value 0 (zero). Normal/Inverse, *21-20 Ext. 1 Normal/Inverse Control* for EXT CL 1, *21-40 Ext. 2 Normal/Inverse Control* for EXT CL 2 and *21-60 Ext. 3 Normal/Inverse Control* for EXT CL 3 are determined during the tuning process.

These calculated values are presented on the LCP and the user can decide whether to accept or reject them. Once accepted, the values are written to the relevant parameters and PID autotuning mode is disabled in *21-09 PID Autotuning*. Depending on the system being controlled the time required to carry out PID autotuning could be several minutes.

Excessive feedback sensor noise should be removed using the input filter (parameter groups 5-5*, 6-**, and 26-**, Terminal 53/54 Filter Time Constant/Pulse Filter Time Constant #29/33) before activating PID autotuning.

21-00 Closed Loop Type	
Option:	Function:
[0] *	Auto
[1]	Fast Pressure
[2]	Slow Pressure
[3]	Fast Temperature
[4]	Slow Temperature

21-01 PID Performance		
Option:	Function:	
[0]	Normal	Normal setting of this parameter will be suitable for pressure control in fan systems.
[1]	Fast	Fast setting would generally be used in pumping systems, where a faster control response is desirable.

21-02 PID Output Change		
Range:	Function:	
0.10 *	[0.01 - 0.50]	This parameter sets the magnitude of step change during autotuning. The value is a percentage of full operating range. I.e. if maximum analog output voltage is set to 10 V, 0.10 is 10% of 10 V, which is 1 V. This parameter should be set to a value resulting in feedback changes of between 10% and 20% for best tuning accuracy.

21-03 Minimum Feedback Level		
Range:	Function:	
-999999 *	[-999999.999 - par. 21-04]	The minimum allowable feedback level should be entered here in User Units as defined in 21-10 Ext. 1 Ref./Feedback Unit for EXT CL 1, 21-30 Ext. 2 Ref./Feedback Unit for EXT CL 2 or 21-50 Ext. 3 Ref./Feedback Unit for EXT CL 3. If the level falls below 21-03 Minimum Feedback Level, PID autotuning is aborted and an error message will appear on the LCP.

21-04 Maximum Feedback Level		
Range:	Function:	
999999 *	[par. 21-03 - 999999.999]	The maximum allowable feedback level should be entered here in User units as defined in 21-10 Ext. 1 Ref./Feedback Unit for EXT CL 1, 21-30 Ext. 2 Ref./Feedback Unit for EXT CL 2 or 21-50 Ext. 3 Ref./Feedback Unit for EXT CL 3 If the level rises above 21-04 Maximum Feedback Level, PID autotuning is aborted and an error message will appear on the LCP.

21-09 PID Autotuning		
Option:	Function:	
		This parameter enables selection of the Extended PID controller to be autotuned and starts the PID autotuning for that controller. Once the autotuning has successfully completed and the settings have been accepted or rejected by the user, by pressing [OK] or [Cancel] at the end of tuning, this parameter is reset to [0] Disabled.

21-09 PID Autotuning		
Option:	Function:	
[0] *	Disabled	
[1]	Enabled Ext CL1 PID	
[2]	Enabled Ext CL 2 PID	
[3]	Enabled Ext CL 3 PID	

3.16.3 21-1* Closed Loop 1 Ref/Feedback

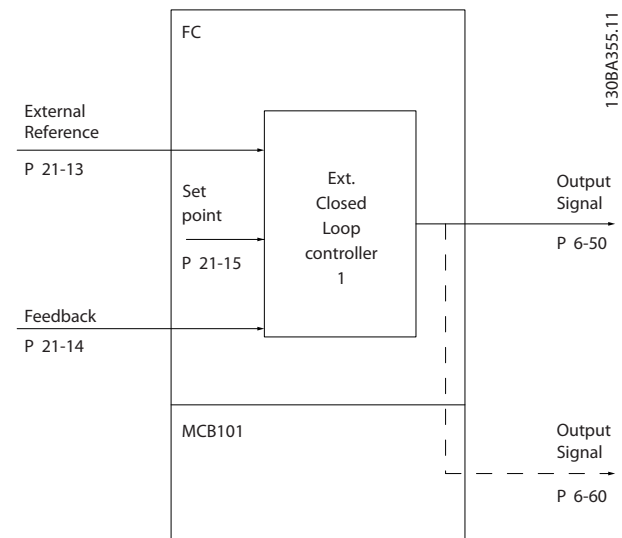

Illustration 3.42

21-10 Ext. 1 Ref./Feedback Unit		
Option:	Function:	
		Select the unit for the reference and feedback.
[0]		
[1] *	%	
[5]	PPM	
[10]	1/min	
[11]	RPM	
[12]	Pulse/s	
[20]	l/s	
[21]	l/min	
[22]	l/h	
[23]	m³/s	
[24]	m³/min	
[25]	m³/h	
[30]	kg/s	
[31]	kg/min	
[32]	kg/h	
[33]	t/min	
[34]	t/h	
[40]	m/s	
[41]	m/min	

21-10 Ext. 1 Ref./Feedback Unit		
Option:	Function:	
[45]	m	
[60]	°C	
[70]	mbar	
[71]	bar	
[72]	Pa	
[73]	kPa	
[74]	m WG	
[80]	kW	
[120]	GPM	
[121]	gal/s	
[122]	gal/min	
[123]	gal/h	
[124]	CFM	
[125]	ft ³ /s	
[126]	ft ³ /min	
[127]	ft ³ /h	
[130]	lb/s	
[131]	lb/min	
[132]	lb/h	
[140]	ft/s	
[141]	ft/min	
[145]	ft	
[160]	°F	
[170]	psi	
[171]	lb/in ²	
[172]	in WG	
[173]	ft WG	
[180]	HP	

21-11 Ext. 1 Minimum Reference		
Range:	Function:	
0 ExtPID1Unit*	[-999999.999 - par. 21-12 ExtPID1Unit]	Select the minimum for the Closed Loop 1 Controller.

21-12 Ext. 1 Maximum Reference		
Range:	Function:	
100 ExtPID1Unit*	[par. 21-11 - 999999.999 ExtPID1Unit]	Select the maximum for the Closed Loop 1 Controller. The dynamics of the PID controller will depend on the value set in this parameter. See also 21-21 Ext. 1 Proportional Gain.

NOTE

Always set the desired value for 21-12 Ext. 1 Maximum Reference before setting the values for the PID controller in parameter group 20-9*.

21-13 Ext. 1 Reference Source		
Option:	Function:	
		This parameter defines which input on the frequency converter should be treated as the source of the reference signal for the Closed Loop 1 Controller. Analog input X30/11 and Analog input X30/12 refer to inputs on the General Purpose I/O.
[0] *	No function	
[1]	Analog Input 53	
[2]	Analog Input 54	
[7]	Pulse input 29	
[8]	Pulse input 33	
[20]	Digital pot.meter	
[21]	Analog input X30/11	
[22]	Analog input X30/12	
[23]	Analog Input X42/1	
[24]	Analog Input X42/3	
[25]	Analog Input X42/5	
[30]	Ext. Closed Loop 1	
[31]	Ext. Closed Loop 2	
[32]	Ext. Closed Loop 3	

21-14 Ext. 1 Feedback Source		
Option:	Function:	
		This parameter defines which input on the frequency converter should be treated as the source of the feedback signal for the Closed Loop 1 controller. Analog input X30/11 and Analog input X30/12 refer to inputs on the General Purpose I/O.
[0] *	No function	
[1]	Analog Input 53	
[2]	Analog Input 54	
[3]	Pulse input 29	
[4]	Pulse input 33	
[7]	Analog Input X30/11	
[8]	Analog Input X30/12	
[9]	Analog Input X42/1	
[10]	Analog Input X42/3	
[11]	Analog Input X42/5	
[100]	Bus Feedback 1	
[101]	Bus Feedback 2	
[102]	Bus feedback 3	

21-15 Ext. 1 Setpoint		
Range:		Function:
0 ExtPID1Unit*	[par. 21-11 - par. 21-12 ExtPID1Unit]	The setpoint reference is used in extended 1 closed loop. Ext.1 Setpoint is added to the value from the Ext.1 Reference source selected in 21-13 Ext. 1 Reference Source.

21-17 Ext. 1 Reference [Unit]		
Range:		Function:
0 ExtPID1Unit*	[-999999.999 - 999999.999 ExtPID1Unit]	Readout of the reference value for the Closed Loop 1 Controller.

21-18 Ext. 1 Feedback [Unit]		
Range:		Function:
0 ExtPID1Unit*	[-999999.999 - 999999.999 ExtPID1Unit]	Readout of the feedback value for the Closed Loop 1 Controller.

21-19 Ext. 1 Output [%]		
Range:		Function:
0 %*	[0 - 100 %]	Readout of the output value for the Closed Loop 1 Controller.

3.16.4 21-2* Closed Loop 1 PID

21-20 Ext. 1 Normal/Inverse Control		
Option:	Function:	
[0]	Normal	Select [0] Normal if the output should be reduced when feedback is higher than the reference.
[1]	Inverse	Select [1] Inverse if the output should be increased when feedback is higher than the reference.

21-21 Ext. 1 Proportional Gain		
Range:		Function:
0.01 *	[0 - 10]	The proportional gain indicates the number of times the error between the set point and the feedback signal is to be applied.

If (Error x Gain) jumps with a value equal to what is set in 20-14 Maximum Reference/Feedb., the PID controller will try to change the output speed equal to what is set in 4-13 Motor Speed High Limit [RPM]/4-14 Motor Speed High Limit [Hz] but in practice of course limited by this setting. The proportional band (error causing output to change from 0-100%) can be calculated by means of the formula

$$\left(\frac{1}{\text{Proportional Gain}} \right) \times (\text{Max Reference})$$

NOTE

Always set the desired for 20-14 Maximum Reference/Feedb. before setting the values for the PID controller in parameter group 20-9*.

21-22 Ext. 1 Integral Time		
Range:		Function:
10000 s*	[0.01 - 10000 s]	Over time, the integrator accumulates a contribution to the output from the PID controller as long as there is a deviation between the Reference/Setpoint and feedback signals. The contribution is proportional to the size of the deviation. This ensures that the deviation (error) approaches zero. Quick response on any deviation is obtained when the integral time is set to a low value. Setting it too low, however, may cause the control to become unstable. The value set, is the time needed for the integrator to add the same contribution as the proportional for a certain deviation. If the value is set to 10,000, the controller will act as a pure proportional controller with a P-band based on the value set in 20-93 PID Proportional Gain. When no deviation is present, the output from the proportional controller will be 0.

21-23 Ext. 1 Differentiation Time		
Range:		Function:
0 s*	[0 - 10 s]	The differentiator does not react to a constant error. It only provides a gain when the feedback changes. The quicker the feedback changes, the stronger the gain from the differentiator.

21-24 Ext. 1 Dif. Gain Limit		
Range:		Function:
5 *	[1 - 50]	Set a limit for the differentiator gain (DG). The DG will increase if there are fast changes. Limit the DG to obtain a pure differentiator gain at slow changes and a constant differentiator gain where quick changes occur.

3.16.5 21-3* Closed Loop 2 Ref/Fb

21-30 Ext. 2 Ref./Feedback Unit		
Option:	Function:	
		See 21-10 Ext. 1 Ref./Feedback Unit for details
[0]		
[1] *	%	
[5]	PPM	
[10]	1/min	
[11]	RPM	
[12]	Pulse/s	

21-30 Ext. 2 Ref./Feedback Unit		
Option:	Function:	
[20]	l/s	
[21]	l/min	
[22]	l/h	
[23]	m ³ /s	
[24]	m ³ /min	
[25]	m ³ /h	
[30]	kg/s	
[31]	kg/min	
[32]	kg/h	
[33]	t/min	
[34]	t/h	
[40]	m/s	
[41]	m/min	
[45]	m	
[60]	°C	
[70]	mbar	
[71]	bar	
[72]	Pa	
[73]	kPa	
[74]	m WG	
[80]	kW	
[120]	GPM	
[121]	gal/s	
[122]	gal/min	
[123]	gal/h	
[124]	CFM	
[125]	ft ³ /s	
[126]	ft ³ /min	
[127]	ft ³ /h	
[130]	lb/s	
[131]	lb/min	
[132]	lb/h	
[140]	ft/s	
[141]	ft/min	
[145]	ft	
[160]	°F	
[170]	psi	
[171]	lb/in ²	
[172]	in WG	
[173]	ft WG	
[180]	HP	

21-31 Ext. 2 Minimum Reference		
Range:	Function:	
0 ExtPID2Unit*	[-999999.999 - par. 21-32 ExtPID2Unit]	See 21-11 Ext. 1 Minimum Reference for details.

21-32 Ext. 2 Maximum Reference		
Range:	Function:	
100 ExtPID2Unit*	[par. 21-31 - 999999.999 ExtPID2Unit]	See 21-12 Ext. 1 Maximum Reference for details.

21-33 Ext. 2 Reference Source		
Option:	Function:	
		See 21-13 Ext. 1 Reference Source for details.
[0] *	No function	
[1]	Analog Input 53	
[2]	Analog Input 54	
[7]	Pulse input 29	
[8]	Pulse input 33	
[20]	Digital pot.meter	
[21]	Analog input X30/11	
[22]	Analog input X30/12	
[23]	Analog Input X42/1	
[24]	Analog Input X42/3	
[25]	Analog Input X42/5	
[30]	Ext. Closed Loop 1	
[31]	Ext. Closed Loop 2	
[32]	Ext. Closed Loop 3	

21-34 Ext. 2 Feedback Source		
Option:	Function:	
		See 21-14 Ext. 1 Feedback Source for details.
[0] *	No function	
[1]	Analog Input 53	
[2]	Analog Input 54	
[3]	Pulse input 29	
[4]	Pulse input 33	
[7]	Analog Input X30/11	
[8]	Analog Input X30/12	
[9]	Analog Input X42/1	
[10]	Analog Input X42/3	
[11]	Analog Input X42/5	
[100]	Bus Feedback 1	
[101]	Bus Feedback 2	
[102]	Bus feedback 3	

21-35 Ext. 2 Setpoint		
Range:	Function:	
0 ExtPID2Unit*	[par. 21-31 - par. 21-32 ExtPID2Unit]	See 21-15 Ext. 1 Setpoint for details.

21-37 Ext. 2 Reference [Unit]		
Range:	Function:	
0 ExtPID2Unit*	[-999999.999 - 999999.999 ExtPID2Unit]	See 21-17 Ext. 1 Reference [Unit], Ext. 1 Reference [Unit], for details.

21-38 Ext. 2 Feedback [Unit]		
Range:	Function:	
0 ExtPID2Unit*	[-999999.999 - 999999.999 ExtPID2Unit]	See 21-18 Ext. 1 Feedback [Unit] for details.

21-39 Ext. 2 Output [%]		
Range:	Function:	
0 %*	[0 - 100 %]	See 21-19 Ext. 1 Output [%] for details.

3.16.6 21-4* Closed Loop 2 PID

21-40 Ext. 2 Normal/Inverse Control		
Option:	Function:	
	See 21-20 Ext. 1 Normal/Inverse Control for details.	
[0]	Normal	
[1]	Inverse	

21-41 Ext. 2 Proportional Gain		
Range:	Function:	
0.01 *	[0 - 10]	See 21-21 Ext. 1 Proportional Gain for details.

21-42 Ext. 2 Integral Time		
Range:	Function:	
10000 s*	[0.01 - 10000 s]	See 21-22 Ext. 1 Integral Time for details.

21-43 Ext. 2 Differentiation Time		
Range:	Function:	
0 s*	[0 - 10 s]	See 21-23 Ext. 1 Differentiation Time for details.

21-44 Ext. 2 Dif. Gain Limit		
Range:	Function:	
5 *	[1 - 50]	See 21-24 Ext. 1 Dif. Gain Limit for details.

3.16.7 21-5* Closed Loop 3 Ref/Fb

21-50 Ext. 3 Ref./Feedback Unit		
Option:	Function:	
	See 21-10 Ext. 1 Ref./Feedback Unit for details.	
[0]		
[1] *	%	
[5]	PPM	
[10]	1/min	
[11]	RPM	
[12]	Pulse/s	
[20]	l/s	
[21]	l/min	
[22]	l/h	
[23]	m ³ /s	
[24]	m ³ /min	

21-50 Ext. 3 Ref./Feedback Unit		
Option:	Function:	
[25]	m ³ /h	
[30]	kg/s	
[31]	kg/min	
[32]	kg/h	
[33]	t/min	
[34]	t/h	
[40]	m/s	
[41]	m/min	
[45]	m	
[60]	°C	
[70]	mbar	
[71]	bar	
[72]	Pa	
[73]	kPa	
[74]	m WG	
[80]	kW	
[120]	GPM	
[121]	gal/s	
[122]	gal/min	
[123]	gal/h	
[124]	CFM	
[125]	ft ³ /s	
[126]	ft ³ /min	
[127]	ft ³ /h	
[130]	lb/s	
[131]	lb/min	
[132]	lb/h	
[140]	ft/s	
[141]	ft/min	
[145]	ft	
[160]	°F	
[170]	psi	
[171]	lb/in ²	
[172]	in WG	
[173]	ft WG	
[180]	HP	

21-51 Ext. 3 Minimum Reference		
Range:	Function:	
0 ExtPID3Unit*	[-999999.999 - par. 21-52 ExtPID3Unit]	See 21-11 Ext. 1 Minimum Reference for details.

21-52 Ext. 3 Maximum Reference		
Range:	Function:	
100 ExtPID3Unit*	[par. 21-51 - 999999.999 ExtPID3Unit]	See 21-12 Ext. 1 Maximum Reference for details.

21-53 Ext. 3 Reference Source		
Option:	Function:	
		See 21-13 Ext. 1 Reference Source for details.
[0] *	No function	
[1]	Analog Input 53	
[2]	Analog Input 54	
[7]	Pulse input 29	
[8]	Pulse input 33	
[20]	Digital pot.meter	
[21]	Analog input X30/11	
[22]	Analog input X30/12	
[23]	Analog Input X42/1	
[24]	Analog Input X42/3	
[25]	Analog Input X42/5	
[30]	Ext. Closed Loop 1	
[31]	Ext. Closed Loop 2	
[32]	Ext. Closed Loop 3	

21-54 Ext. 3 Feedback Source		
Option:	Function:	
		See 21-14 Ext. 1 Feedback Source for details.
[0] *	No function	
[1]	Analog Input 53	
[2]	Analog Input 54	
[3]	Pulse input 29	
[4]	Pulse input 33	
[7]	Analog Input X30/11	
[8]	Analog Input X30/12	
[9]	Analog Input X42/1	
[10]	Analog Input X42/3	
[11]	Analog Input X42/5	
[100]	Bus Feedback 1	
[101]	Bus Feedback 2	
[102]	Bus feedback 3	

21-55 Ext. 3 Setpoint		
Range:	Function:	
0 ExtPID3Unit*	[par. 21-51 - par. 21-52 ExtPID3Unit]	See 21-15 Ext. 1 Setpoint for details.

21-57 Ext. 3 Reference [Unit]		
Range:	Function:	
0 ExtPID3Unit*	[-999999.999 - 999999.999 ExtPID3Unit]	See 21-17 Ext. 1 Reference [Unit] for details.

21-58 Ext. 3 Feedback [Unit]		
Range:	Function:	
0 ExtPID3Unit*	[-999999.999 - 999999.999 ExtPID3Unit]	See 21-18 Ext. 1 Feedback [Unit] for details.

21-59 Ext. 3 Output [%]		
Range:	Function:	
0 %*	[0 - 100 %]	See 21-19 Ext. 1 Output [%] for details.

3.16.8 21-6* Closed Loop 3 PID

21-60 Ext. 3 Normal/Inverse Control		
Option:	Function:	
		See 21-20 Ext. 1 Normal/Inverse Control for details.
[0]	Normal	
[1]	Inverse	

21-61 Ext. 3 Proportional Gain		
Range:	Function:	
0.01 *	[0 - 10]	See 21-21 Ext. 1 Proportional Gain for details.

21-62 Ext. 3 Integral Time		
Range:	Function:	
10000 s*	[0.01 - 10000 s]	See 21-22 Ext. 1 Integral Time for details.

21-63 Ext. 3 Differentiation Time		
Range:	Function:	
0 s*	[0 - 10 s]	See 21-23 Ext. 1 Differentiation Time for details.

21-64 Ext. 3 Dif. Gain Limit		
Range:	Function:	
5 *	[1 - 50]	See 21-24 Ext. 1 Dif. Gain Limit for details.

3.17 Main Menu - Application Functions - Group 22

This group contains parameters used for monitoring VLT Refrigeration Drive applications.

3

22-00 External Interlock Delay	
Range:	Function:
0 s* [0 - 600 s]	Only relevant if one of the digital inputs in parameter group 5-1* has been programmed for [7] External Interlock. The External Interlock Timer will introduce a delay after the signal has been

22-00 External Interlock Delay	
Range:	Function:
	removed from the digital input programmed for External Interlock, before reaction takes place.

3.17.1 22-2* No-Flow Detection

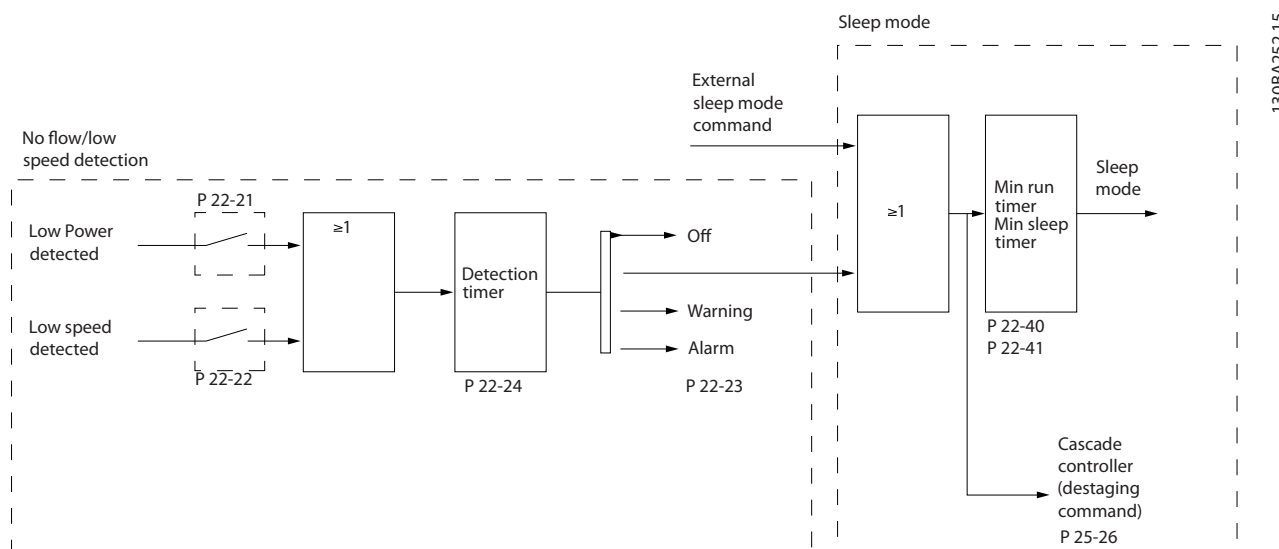

Illustration 3.43

The VLT Refrigeration Drive FC 103 includes functions for detecting if the load conditions in the system allow the motor to be stopped:

- *Low Power Detection
- *Low Speed Detection

One of these two signals must be active for a set time (22-24 No-Flow Delay) before selected action takes place. Possible actions to select (22-23 No-Flow Function): No action, Warning, Alarm, Sleep Mode.

No Flow Detection

This function is used for detecting a no flow situation in pump systems where all valves can be closed. Can be used both when controlled by the integrated PI controller in VLT Refrigeration Drive FC 103 or an external PI controller. Actual configuration must be programmed in 1-00 Configuration Mode.

Configuration mode for

- Integrated PI Controller: Closed Loop
- External PI Controller: Open Loop

CAUTION

Carry out No Flow tuning before setting the PI controller parameters!

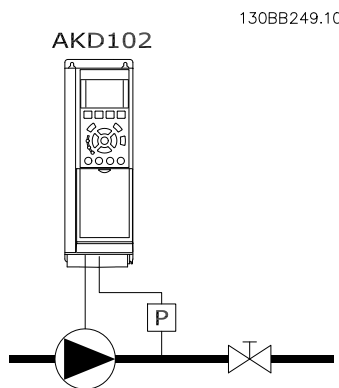

Illustration 3.44

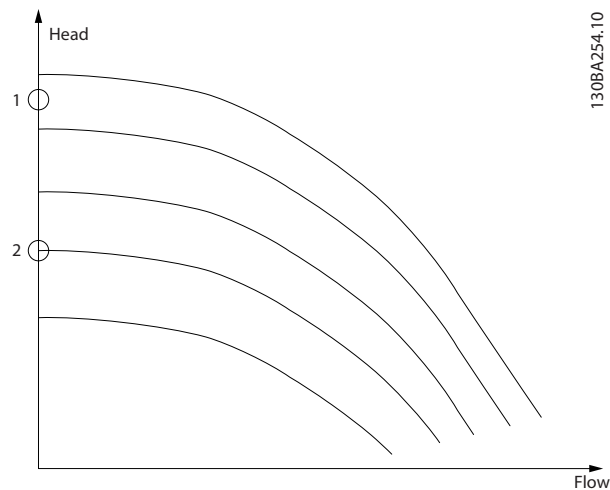

Illustration 3.45

No Flow Detection is based on the measurement of speed and power. For a certain speed the frequency converter calculates the power at no flow. This coherence is based on the adjustment of two sets of speed and associated power at no flow. By monitoring the power it is possible to detect no flow conditions in systems with fluctuating suction pressure or if the pump has a flat characteristic towards low speed. The two sets of data must be based on measurement of power at approx. 50% and 85% of maximum speed with the valve(s) closed. The data are programmed in the parameter group 22-3*. It is also possible to run 22-20 Low Power Auto Set-up, automatically stepping through the commissioning process and also automatically storing the data measured. The frequency converter must be set for [0] Speed Open Loop in 1-00 Configuration Mode, when carrying out the Auto Set Up (See No Flow Tuning parameter group 22-3*).

CAUTION

If to use the integrated PI controller, carry out No Flow tuning before setting the PI controller parameters!

Low speed detection

Low Speed Detection gives a signal if the motor is operating with minimum speed as set in 4-11 Motor Speed Low Limit [RPM] or 4-12 Motor Speed Low Limit [Hz]. Actions are common with No Flow Detection (individual selection not possible).

The use of Low Speed Detection is not limited to systems with a no flow situation, but can be used in any system where operation at minimum speed allows for a stop of the motor until the load calls for a speed higher than minimum speed, e.g. systems with fans and compressors.

CAUTION

In pump systems ensure that the minimum speed in 4-11 Motor Speed Low Limit [RPM] or 4-12 Motor Speed Low Limit [Hz] has been set high enough for detection as the pump can run with a rather high speed even with valves closed.

Dry pump detection

No Flow Detection can also be used for detecting if the pump has run dry (low power consumption-high speed). Can be used with both the integrated PI controller and an external PI controller.

The condition for Dry Pump signal:

- Power consumption below no flow level

and

- Pump running at maximum speed or maximum reference open loop, whichever is lowest.

The signal must be active for a set time (22-27 Dry Pump Delay) before selected the action takes place.

Possible Actions to select (22-26 Dry Pump Function):

- Warning
- Alarm

No Flow Detection must be enabled (22-23 No-Flow Function) and commissioned (parameter group 22-3*, No Power Tuning).

22-20 Low Power Auto Set-up		
Start of auto set-up of power data for No-Flow Power tuning.		
Option:	Function:	
[0] * Off		
[1]	Enabled	When set for Enabled, an auto set up sequence is activated, automatically setting speed to approx. 50 and 85% of rated motor speed (4-13 Motor Speed High Limit [RPM], 4-14 Motor Speed High Limit [Hz]). At those two speeds, the power consumption is automatically measured and stored. Before enabling Auto Set Up: <ol style="list-style-type: none"> 1. Close valve(s) in order to create a no flow condition 2. The frequency converter must be set for Open Loop (1-00 Configuration Mode). Note that it is important also to set 1-03 Torque Characteristics.

NOTE

Auto Set Up must be done when the system has reached normal operating temperature!

NOTE

It is important that the *4-13 Motor Speed High Limit [RPM]* or *4-14 Motor Speed High Limit [Hz]* is set to the max. operational speed of the motor!

It is important to do the Auto Set-up before configuring the integrated PI Controller as settings will be reset when changing from Closed to Open Loop in *1-00 Configuration Mode*.

NOTE

Carry out the tuning with the same settings in *1-03 Torque Characteristics*, as for operation after the tuning.

22-21 Low Power Detection		
Option:	Function:	
[0] *	Disabled	
[1]	Enabled	If selecting Enabled, the Low Power Detection commissioning must be carried out in order to set the parameters in parameter group 22-3* for proper operation!

22-22 Low Speed Detection		
Option:	Function:	
[0] *	Disabled	
[1]	Enabled	Select Enabled for detecting when the motor operates with a speed as set in <i>4-11 Motor Speed Low Limit [RPM]</i> or <i>4-12 Motor Speed Low Limit [Hz]</i> .

22-23 No-Flow Function		
Common actions for Low Power Detection and Low Speed Detection (Individual selections not possible).		
Option:	Function:	
[0] *	Off	
[1]	Sleep Mode	The frequency converter will enter Sleep Mode and stop when a No Flow condition is detected. See parameter group 22-4* for programming options for Sleep Mode.
[2]	Warning	The frequency converter will continue to run, but activate a No-Flow Warning [W92]. A drive digital output or a serial communication bus can communicate a warning to other equipment.
[3]	Alarm	The frequency converter will stop running and activate a No-Flow Alarm [A 92]. A frequency converter digital output or a serial communication bus can communicate an alarm to other equipment.

NOTE

Do not set *14-20 Reset Mode*, to *[13] Infinite auto reset*, when *22-23 No-Flow Function* is set to *[3] Alarm*. Doing so will cause the frequency converter to continuously cycle between running and stopping when a No Flow condition is detected.

NOTE

If the frequency converter is equipped with a constant speed bypass with an automatic bypass function that starts the bypass if the frequency converter experiences a persistent alarm condition, be sure to disable the bypass's automatic bypass function, if *[3] Alarm* is selected as the No-Flow Function.

22-24 No-Flow Delay		
Range:	Function:	
10 s*	[1 - 600 s]	Set the time Low Power/Low Speed must stay detected to activate signal for actions. If detection disappears before run out of the timer, the timer will be reset.

22-26 Dry Pump Function		
Select desired action for dry pump operation.		
Option:	Function:	
[0] *	Off	
[1]	Warning	The frequency converter will continue to run, but activate a Dry pump warning [W93]. A frequency converter digital output or a serial communication bus can communicate a warning to other equipment.
[2]	Alarm	The frequency converter will stop running and activate a Dry pump alarm [A93]. A frequency converter digital output or a serial communication bus can communicate an alarm to other equipment.

NOTE

Low Power Detection must be Enabled (*22-21 Low Power Detection*) and commissioned (using either parameter group 22-3*, *No Flow Power Tuning*, or *22-20 Low Power Auto Set-up*) in order to use Dry Pump Detection.

NOTE

Do not set *14-20 Reset Mode*, to *[13] Infinite auto reset*, when *22-26 Dry Pump Function* is set to *[2] Alarm*. Doing so will cause the frequency converter to continuously cycle between running and stopping when a Dry Pump condition is detected.

NOTE

If the frequency converter is equipped with a constant speed bypass with an automatic bypass function that starts the bypass if the frequency converter experiences a persistent alarm condition, be sure to disable the bypass's automatic bypass function, if [2] Alarm or [3] Man. Reset Alarm is selected as the Dry Pump Function.

22-27 Dry Pump Delay		
Range:	Function:	
10 s*	[0 - 600 s]	Defines for how long the Dry Pump condition must be active before activating Warning or Alarm

3.17.2 22-3* No-Flow Power Tuning

Tuning Sequence, if not choosing *Auto Set Up* in 22-20 *Low Power Auto Set-up*:

1. Close the main valve to stop flow.
2. Run with motor until the system has reached normal operating temperature.
3. Press [Hand On] and adjust speed for approx. 85% of rated speed. Note the exact speed.
4. Read power consumption either by looking for actual power in the data line in the LCP or call 16-10 *Power [kW]* or 16-11 *Power [hp]* in Main Menu. Note the power read out.
5. Change speed to approx. 50% of rated speed. Note the exact speed.
6. Read power consumption either by looking for actual power in the data line in the LCP or call 16-10 *Power [kW]* or 16-11 *Power [hp]* in Main Menu. Note the power read.
7. Program the speeds used in 22-32 *Low Speed [RPM]*, 22-33 *Low Speed [Hz]*, 22-36 *High Speed [RPM]* and 22-37 *High Speed [Hz]*.
8. Program the associated power values in 22-34 *Low Speed Power [kW]*, 22-35 *Low Speed Power [HP]*, 22-38 *High Speed Power [kW]* and 22-39 *High Speed Power [HP]*.
9. Switch back by means of [Auto On] or [Off].

NOTE

Set 1-03 *Torque Characteristics* before tuning takes place.

22-30 No-Flow Power		
Range:	Function:	
0 kW*	[0 - 1000 kW]	Read out of calculated No Flow power at actual speed. If power drops to the display value the frequency converter will consider the condition as a No Flow situation.

22-31 Power Correction Factor		
Range:	Function:	
100 %*	[1 - 400 %]	Make corrections to the calculated power at 22-30 <i>No-Flow Power</i> . If No Flow is detected, when it should not be detected, the setting should be decreased. However, if No Flow is not detected, when it should be detected, the setting should be increased to above 100%.

22-32 Low Speed [RPM]		
Range:	Function:	
Size related*	[0 - par. 22-36 RPM]	To be used if 0-02 <i>Motor Speed Unit</i> has been set for RPM (parameter not visible if Hz selected). Set used speed for the 50% level. This function is used for storing values needed to tune No Flow Detection.

22-33 Low Speed [Hz]		
Range:	Function:	
Size related*	[0 - par. 22-37 Hz]	To be used if 0-02 <i>Motor Speed Unit</i> has been set for Hz (parameter not visible if RPM selected). Set used speed for the 50% level. The function is used for storing values needed to tune No Flow Detection.

22-34 Low Speed Power [kW]		
Range:	Function:	
Size related*	[0 - 0.00 kW]	To be used if 0-03 <i>Regional Settings</i> has been set for International (parameter not visible if North America selected). Set power consumption at 50% speed level. This function is used for storing values needed to tune No Flow Detection.

22-35 Low Speed Power [HP]		
Range:	Function:	
Size related*	[0 - 0.00 hp]	To be used if 0-03 <i>Regional Settings</i> has been set for North America (parameter not visible if International selected). Set power consumption at 50% speed level. This function is used for storing values needed to tune No Flow Detection.

22-36 High Speed [RPM]		
Range:		Function:
Size related*	[0 - par. 4-13 RPM]	To be used if 0-02 Motor Speed Unit has been set for RPM (parameter not visible if Hz selected). Set used speed for the 85% level. The function is used for storing values needed to tune No Flow Detection.

22-37 High Speed [Hz]		
Range:		Function:
Size related*	[0 - par. 4-14 Hz]	To be used if 0-02 Motor Speed Unit has been set for Hz (parameter not visible if RPM selected). Set used speed for the 85% level. The function is used for storing values needed to tune No Flow Detection.

22-38 High Speed Power [kW]		
Range:		Function:
Size related*	[0 - 0.00 kW]	To be used if 0-03 Regional Settings has been set for International (parameter not visible if North America selected). Set power consumption at 85% speed level. This function is used for storing values needed to tune No Flow Detection.

22-39 High Speed Power [HP]		
Range:		Function:
Size related*	[0 - 0.00 hp]	To be used if 0-03 Regional Settings has been set for North America (parameter not visible if International selected). Set power consumption at 85% speed level. This function is used for storing values needed to tune No Flow Detection.

parameters for configuration of the digital inputs, parameter group 5-1* selecting Sleep Mode).

To make it possible to use e.g. an electro-mechanical flow switch to detect a no flow condition and activate Sleep Mode, the action takes place at raising edge of the external signal applied (otherwise the frequency converter would never come out of Sleep Mode again as the signal would be steady connected).

If 25-26, *Destage at No-Flow*, is set for Enabled, activating Sleep Mode will apply a command to the cascade controller (if enabled) to start destaging of lag pumps (fixed speed) before stopping the lead pump (variable speed).

When entering Sleep Mode, the lower status line in the Local Control Panel shows Sleep Mode.

See also signal flow chart in 3.17.1 22-2* *No-Flow Detection*. There are three different ways of using the Sleep Mode function:

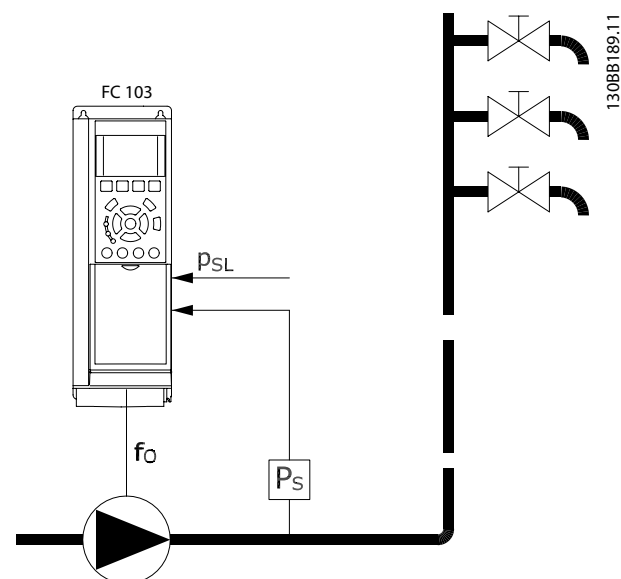

Illustration 3.46

3.17.3 22-4* Sleep Mode

If the load on the system allows for stop of the motor and the load is monitored, the motor can be stopped by activating the Sleep Mode function. This is not a normal Stop command, but ramps the motor down to 0 RPM and stops energizing the motor. When in Sleep Mode certain conditions are monitored to find out when load has been applied to the system again.

Sleep Mode can be activated either from the No Flow Detection/Minimum Speed Detection (must be programmed via parameters for No-Flow Detection, see *Illustration 3.43*) or via an external signal applied to one of the digital inputs (must be programmed via the

1) Systems where the integrated PI controller is used for controlling pressure or temperature e.g. boost systems with a pressure feed back signal applied to the frequency converter from a pressure transducer. Par. 1-00, *Configuration Mode*, must be set for Closed Loop and the PI Controller configured for desired reference and feed back signals.

Example: Boost system.

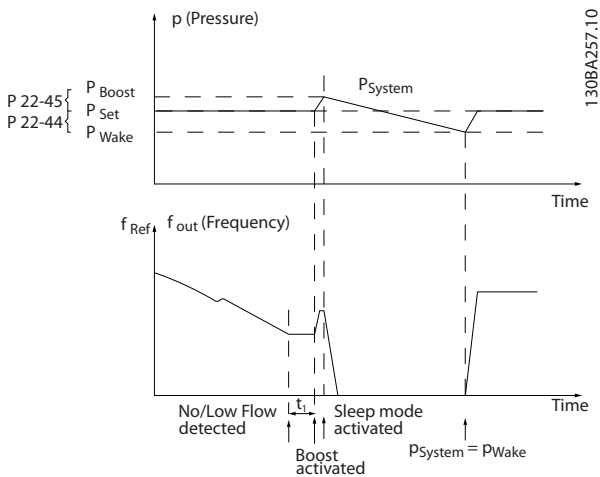

Illustration 3.47

If no flow is detected, the frequency converter will increase the set point for pressure to ensure a slight over pressure in the system (boost to be set in 22-45 Setpoint Boost). The feedback from the pressure transducer is monitored and when this pressure has dropped with a set percentage below the normal set point for pressure (P_{set}), the motor will ramp up again and pressure will be controlled for reaching the set value (P_{set}).

2) In systems where the pressure or temperature is controlled by an external PI controller, the wake up conditions can not be based on feedback from the pressure/temperature transducer as the setpoint is not known. In the example with a boost system, desired pressure P_{set} is not known. Par. 1-00, Configuration mode, must be set for Open Loop. Example: Boost system.

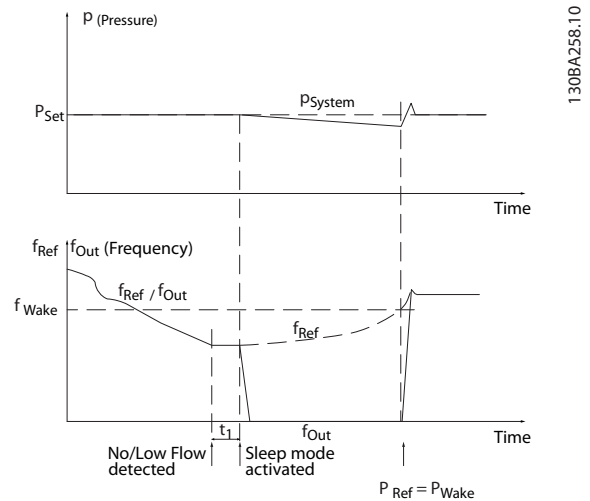

Illustration 3.49

When low power or low speed is detected the motor is stopped, but the reference signal (f_{ref}) from the external controller is still monitored and because of the low pressure created, the controller will increase the reference signal to gain pressure. When the reference signal has reached a set value f_{wake} the motor restarts.

The speed is set manually by an external reference signal (Remote Reference). The settings (parameter group 22-3*) for tuning of the No Flow function must be set to default.

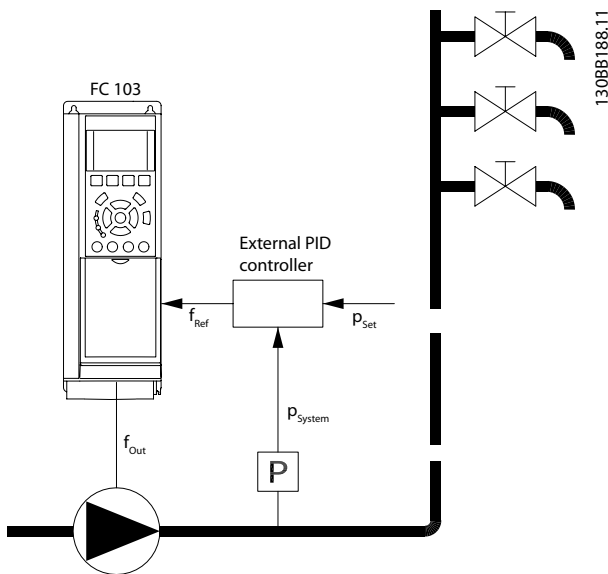

Illustration 3.48

	Internal PI Controller (1-00 Configuration Mode: [3] Process Closed Loop)		External PI Controller or manual control (1-00 Configuration Mode: [0] Speed Open Loop)	
	Sleep mode	Wake up	Sleep mode	Wake up
No Flow detection (pumps only)	Yes		Yes (except manual setting of speed)	
Low speed detection	Yes		Yes	
External signal	Yes		Yes	
Pressure/Temperature (transmitter connected)		Yes		No
Output frequency		No		Yes

Table 3.25 Configuration Possibilities, Overview

NOTE

Sleep Mode will not be active when Local Reference is active (set speed manually by means of arrow buttons on the Local Control Panel). See Par. 3-13, *Reference Site*. Does not work in Hand-mode. Auto set-up in open loop must be carried out before setting input/output in closed loop.

22-40 Minimum Run Time		
Range:	Function:	
10 s* [0 - 600 s]	Set the desired minimum running time for the motor after a start command (digital input or Bus) before entering Sleep Mode.	

22-41 Minimum Sleep Time		
Range:	Function:	
10 s* [0 - 600 s]	Set the desired Minimum Time for staying in Sleep Mode. This will override any wake up conditions.	

22-42 Wake-up Speed [RPM]		
Range:	Function:	
Size related* [par. 4-11 - par. 4-13 RPM]	To be used if 0-02 Motor Speed Unit has been set for RPM (parameter not visible if Hz selected). Only to be used if 1-00 Configuration Mode is set for Open Loop and speed reference is applied by an external controller. Set the reference speed at which the Sleep Mode should be cancelled.	

22-43 Wake-up Speed [Hz]		
Range:	Function:	
Size related* [par. 4-12 - par. 4-14 Hz]	To be used if 0-02 Motor Speed Unit, has been set for Hz (parameter not visible if RPM selected). Only to be used if 1-00 Configuration Mode, is set for Open Loop and speed reference is applied by an external controller controlling the pressure. Set the reference speed at which the Sleep Mode should be cancelled.	

22-44 Wake-up Ref./FB Difference		
Range:	Function:	
10 %* [0 - 100 %]	Only to be used if 1-00 Configuration Mode is set for Closed Loop and the integrated PI controller is used for controlling the pressure. Set the pressure drop allowed in percentage of set point for the pressure (P_{set}) before cancelling the Sleep Mode.	

NOTE

If used in application where the integrated PI controller is set for inverse control (e.g. cooling tower applications) in 20-71 PID Performance, the value set in 22-44 Wake-up Ref./FB Difference will automatically be added.

22-45 Setpoint Boost		
Range:	Function:	
0 %* [-100 - 100 %]	Only to be used if 1-00 Configuration Mode, is set for Closed Loop and the integrated PI controller is used. In systems with e.g. constant pressure control, it is advantageous to increase the system pressure before the motor is stopped. This will extend the time in which the motor is stopped and help to avoid frequent start/stop. Set the desired over pressure/temperature in percentage of set point for the pressure (P_{set})/temperature before entering the Sleep Mode. If setting for 5%, the boost pressure will be $P_{set} * 1.05$. The negative values can be used for e.g. cooling tower control where a negative change is needed.	

22-46 Maximum Boost Time		
Range:	Function:	
60 s* [0 - 600 s]	Only to be used if 1-00 Configuration Mode is set for Closed Loop and the integrated PI controller is used for controlling the pressure. Set the maximum time for which boost mode will be allowed. If the set time is exceeded, Sleep Mode will be entered, not waiting for the set boost pressure to be reached.	

3.17.4 22-5* End of Curve

The End of Curve conditions occur when a pump is yielding a too large volume to ensure the set pressure. This can occur if there is a leakage in the distribution pipe system after the pump causing the pump to operate at the end of the pump characteristic, valid for the max. speed set in 4-13 *Motor Speed High Limit [RPM]* or 4-14 *Motor Speed High Limit [Hz]*.

In case the feed back is 2.5% of the programmed value in 20-14 *Maximum Reference/Feedb.* (or numerical value of 20-13 *Minimum Reference/Feedb.* whichever is highest) below the set point for the desired pressure for a set time (22-51 *End of Curve Delay*), and the pump is running with max. speed set in 4-13 *Motor Speed High Limit [RPM]* or 4-14 *Motor Speed High Limit [Hz]*, - the function selected in 22-50 *End of Curve Function* will take place.

It is possible to get a signal on one of the digital outputs by selecting End of Curve [192] in parameter group 5-3* *Digital Outputs* and/or parameter group 5-4* *Relays*. The signal will be present, when an End of Curve condition occurs and the selection in 22-50 *End of Curve Function*, is different from Off. The end of curve function can only be used when operating with the built-in PID controller (Closed loop in 1-00 *Configuration Mode*).

22-50 End of Curve Function		
Option:	Function:	
[0] *	Off	End of Curve monitoring not active.
[1]	Warning	The frequency converter will continue to run, but activate a End of Curve warning [W94]. A frequency converter digital output or a serial communication bus can communicate a warning to other equipment.
[2]	Alarm	The frequency converter will stop running and activate a End of Curve alarm [A 94]. A frequency converter digital output or a serial communication bus can communicate an alarm to other equipment.

NOTE

Automatic restart will reset the alarm and start the system again.

NOTE

Do not set 14-20 *Reset Mode*, to [13] *Infinite auto reset*, when 22-50 *End of Curve Function* is set to [2] *Alarm*. Doing so will cause the frequency converter to continuously cycle between running and stopping when a End of Curve condition is detected.

NOTE

If the frequency converter is equipped with a constant speed bypass with an automatic bypass function that starts the bypass if the frequency converter experiences a persistent alarm condition, be sure to disable the bypass's automatic bypass function, if [2] *Alarm* or [3] *Man. Reset Alarm* is selected as the End of Curve Function.

22-51 End of Curve Delay		
Range:	Function:	
10 s* [0 - 600 s]	When an End of Curve condition is detected, a timer is activated. When the time set in this parameter expires, and the End of Curve condition has been steady in the entire period, the function set in 22-50 <i>End of Curve Function</i> will be activated. If the condition disappears before the timer expires, the timer will be reset.	

3.17.5 22-6* Broken Belt Detection

The Broken Belt Detection can be used in both closed and open loop systems for pumps, fans and compressors. If the estimated motor torque is below the broken belt torque value (22-61 *Broken Belt Torque*) and the frequency converter output frequency is above or equal to 15 Hz, the broken belt function (22-60 *Broken Belt Function*) is performed

22-60 Broken Belt Function		
Selects the action to be performed if the Broken Belt condition is detected		
Option:	Function:	
[0] *	Off	
[1]	Warning	The frequency converter will continue to run, but activate a Broken Belt Warning [W95]. A frequency converter digital output or a serial communication bus can communicate a warning to other equipment.
[2]	Trip	The frequency converter will stop running and activate a Broken Belt alarm [A 95]. A frequency converter digital output or a serial communication bus can communicate an alarm to other equipment.

NOTE

Do not set 14-20 *Reset Mode*, to [13] *Infinite auto reset*, when 22-60 *Broken Belt Function* is set to [2] *Trip*. Doing so will cause the frequency converter to continuously cycle between running and stopping when a broken belt condition is detected.

NOTE

If the frequency converter is equipped with a constant speed bypass with an automatic bypass function that starts the bypass if the frequency converter experiences a persistent alarm condition, be sure to disable the bypass's automatic bypass function, if [2] Trip is selected as the Broken Belt Function.

22-61 Broken Belt Torque		
Range:	Function:	
10 %*	[0 - 100 %]	Sets the broken belt torque as a percentage of the rated motor torque.

22-62 Broken Belt Delay		
Range:	Function:	
10 s	[0 - 600 s]	Sets the time for which the Broken Belt conditions must be active before carrying out the action selected in 22-60 Broken Belt Function.

3.17.6 22-7* Short Cycle Protection

When controlling refrigeration compressors, often there will be a need for limiting the numbers of starts. One way to do this is to ensure a minimum run time (time between a start and a stop) and a minimum interval between starts. This means that any normal stop command can be overridden by the *Minimum Run Time* function (22-77 *Minimum Run Time*) and any normal start command (Start/Jog/Freeze) can be overridden by the *Interval Between Starts* function (22-76 *Interval between Starts*). None of the two functions are active if *Hand On* or *Off* modes have been activated via the LCP. If selecting *Hand On* or *Off*, the two timers will be reset to 0, and not start counting until *Auto* is pressed and an active start command applied.

NOTE

A Coast command or missing Run Permissive signal will override both Minimum Run Time and Interval Between Starts functions.

22-75 Short Cycle Protection		
Option:	Function:	
[0]	Disabled	Timer set in 22-76 <i>Interval between Starts</i> is disabled.
[1]	Enabled	Timer set in 22-76 <i>Interval between Starts</i> is enabled.

22-76 Interval Between Starts		
Range:	Function:	
300 s*	[0 - 3600 s]	Sets the time desired as minimum time between two starts. Any normal start command (Start/Jog/Freeze) will be disregarded until the timer has expired.

22-77 Minimum Run Time		
Range:	Function:	
0 s*	[0 - par. 22-76 s]	Sets the time desired as minimum run time after a normal start command (Start/Jog/Freeze). Any normal stop command will be disregarded until the set time has expired. The timer will start counting following a normal start command (Start/Jog/Freeze). The timer will be overridden by a Coast (Inverse) or an External Interlock command.

NOTE

Does not work in cascade mode.

22-78 Minimum Run Time Override		
Option:	Function:	
[0]	Disabled	
[1]	Enabled	

22-79 Minimum Run Time Override Value		
Range:	Function:	
0 ProcessCtrlUnit*	[-999999.999 - 999999.999 ProcessCtrlUnit]	

3.17.7 22-8* Flow Compensation

It is sometimes the case that is not possible for a pressure transducer to be placed at a remote point in the system and it can only be located close to the fan/pump outlet. Flow compensation operates by adjusting the set-point according to the output frequency, which is almost proportional to flow, thus compensating for higher losses at higher flow rates.

H_{DESIGN} (Required pressure) is the setpoint for closed loop (PI) operation of the frequency converter and is set as for closed loop operation without flow compensation.

It is recommended to use slip compensation and RPM as unit.

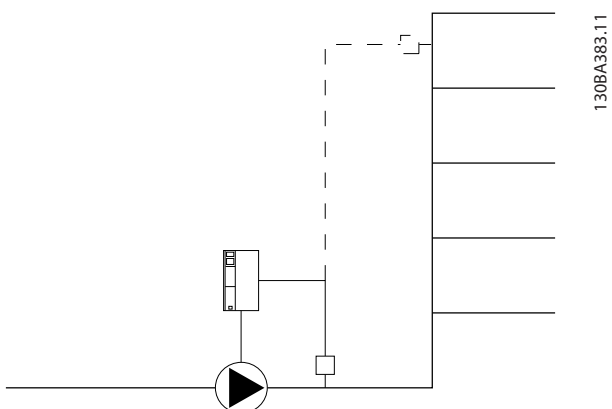

Illustration 3.50

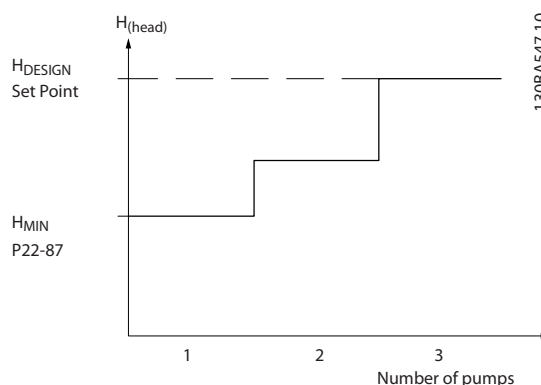

Illustration 3.51

NOTE

When flow compensation is used with the Cascade Controller (parameter group 25-**), the actual set-point will not depend on speed (flow) but on the number of pumps cut in. See below:

There are two methods which can be employed, depending upon whether or not the Speed at System design Working Point is known.

Parameter used	Speed at Design Point KNOWN	Speed at Design Point UNKNOWN	Cascade Controller
22-80 Flow Compensation	+	+	+
22-81 Square-linear Curve Approximation	+	+	-
22-82 Work Point Calculation	+	+	-
22-83 Speed at No-Flow [RPM]/22-84 Speed at No-Flow [Hz]	+	+	-
22-85 Speed at Design Point [RPM]/22-86 Speed at Design Point [Hz]	+	-	-
22-87 Pressure at No-Flow Speed	+	+	+
22-88 Pressure at Rated Speed	-	+	-
22-89 Flow at Design Point	-	+	-
22-90 Flow at Rated Speed	-	+	-

Table 3.26

22-80 Flow Compensation		
Option:	Function:	
[0] *	Disabled	Set-Point compensation not active.
[1]	Enabled	Set-Point compensation is active. Enabling this parameter allows the Flow Compensated Setpoint operation.

22-81 Square-linear Curve Approximation		
Range:	Function:	
100 %*	[0 - 100 %]	Example 1: Adjustment of this parameter allows the shape of the control curve to be adjusted. 0 = Linear 100% = Ideal shape (theoretical).

NOTE

Not visible when running in cascade.

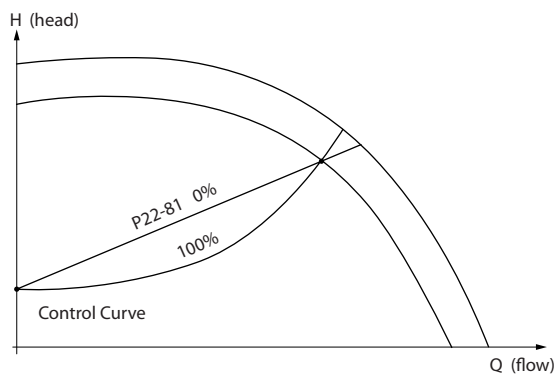

Illustration 3.52

22-82 Work Point Calculation

Option: **Function:**

Example 1:

Illustration 3.53 Speed at System Design Working Point is Known

From the data sheet showing characteristics for the specific equipment at different speeds, simply reading across from the H_{DESIGN} point and the Q_{DESIGN} point allows us to find point A, which is the System Design Working Point. The pump characteristics at this point should be identified and the associated speed programmed. Closing the valves and adjusting the speed until H_{MIN} has been achieved allows the speed at the no flow point to be identified.

Adjustment of 22-81 Square-linear Curve Approximation then allows the shape of the control curve to be adjusted infinitely.

Example 2:

Speed at System Design Working Point is not known: Where the Speed at System Design Working Point is unknown, another reference point on the control curve needs to be determined by means of the data sheet. By looking at the curve for the rated speed and plotting the design pressure (H_{DESIGN} , Point C) the flow at that pressure Q_{RATED} can be determined. Similarly, by plotting the design flow (Q_{DESIGN} , Point D). The pressure H_{DESIGN} at that flow can be determined. Knowing these two points on the pump curve, along with H_{MIN} as described above, allows the frequency converter to calculate the reference point B and thus to plot the control curve which will also include the System design Working Point A.

22-82 Work Point Calculation

Option: **Function:**

Illustration 3.54

[0]	Disabled	Work Point Calculation not active. To be used if speed at design point is known (see Table 3.26).
[1]	Enabled	Work Point Calculation is active. Enabling this parameter allows the calculation of the unknown System Design Working Point at 50/60 Hz speed, from the input data set in 22-83 Speed at No-Flow [RPM] 22-84 Speed at No-Flow [Hz], 22-87 Pressure at No-Flow Speed, 22-88 Pressure at Rated Speed, 22-89 Flow at Design Point and 22-90 Flow at Rated Speed.

22-83 Speed at No-Flow [RPM]

Range: **Function:**

Size related*	[0 - par. 22-85 RPM]	Resolution 1 RPM. The speed of the motor at which flow is zero and minimum pressure H_{MIN} is achieved should be entered here in RPM. Alternatively, the speed in Hz can be entered in 22-84 Speed at No-Flow [Hz]. If it has been decided to use RPM in 0-02 Motor Speed Unit then 22-85 Speed at Design Point [RPM] should also be used. Closing the valves and reducing the speed until minimum pressure H_{MIN} is achieved will determine this value.
---------------	-----------------------	---

22-84 Speed at No-Flow [Hz]		
Range:		Function:
Size related*	[0 - par. 22-86 Hz]	Resolution 0.033 Hz. The speed of the motor at which flow has effectively stopped and minimum pressure H_{MIN} is achieved should be entered here in Hz. Alternatively, the speed in RPM can be entered in 22-83 Speed at No-Flow [RPM]. If it has been decided to use Hz in 0-02 Motor Speed Unit then 22-86 Speed at Design Point [Hz] should also be used. Closing the valves and reducing the speed until minimum pressure H_{MIN} is achieved will determine this value.

22-85 Speed at Design Point [RPM]		
Range:		Function:
Size related*	[par. 22-83 - 60000 RPM]	Resolution 1 RPM. Only visible when 22-82 Work Point Calculation is set to Disable. The speed of the motor at which the System Design Working Point is achieved should be entered here in RPM. Alternatively, the speed in Hz can be entered in 22-86 Speed at Design Point [Hz]. If it has been decided to use RPM in 0-02 Motor Speed Unit then 22-83 Speed at No-Flow [RPM] should also be used.

22-86 Speed at Design Point [Hz]		
Range:		Function:
Size related*	[par. 22-84 - par. 4-19 Hz]	Resolution 0.033 Hz. Only visible when 22-82 Work Point Calculation is set to Disable. The speed of the motor at which the System Design Working Point is achieved should be entered here in Hz. Alternatively, the speed in RPM can be entered in 22-85 Speed at Design Point [RPM]. If it has been decided to use Hz in 0-02 Motor Speed Unit, then 22-83 Speed at No-Flow [RPM] should also be used.

22-87 Pressure at No-Flow Speed		
Range:		Function:
0 *	[0 - par. 22-88]	Enter the pressure H_{MIN} corresponding to Speed at No Flow in Reference/Feedback Units.

Also see 22-82 Work Point Calculation point D.

22-88 Pressure at Rated Speed		
Range:		Function:
999999 *	[par. 22-87 - 999999.999]	Enter the value corresponding to the Pressure at Rated Speed, in Reference/Feedback Units. This value can be defined using the pump datasheet.

Also see 22-82 Work Point Calculation point A.

22-89 Flow at Design Point		
Range:		Function:
0 *	[0 - 999999.999]	Enter the value corresponding to the Flow at Design Point. No units necessary.

Also see 22-82 Work Point Calculation point C.

22-90 Flow at Rated Speed		
Range:		Function:
0 *	[0 - 999999.999]	Enter the value corresponding to Flow at Rated Speed. This value can be defined using the pump datasheet.

3.18 Main Menu - Time-based Functions - Group 23

3.18.1 23-0* Timed Actions

Use *Timed Actions* for actions needing to be performed on a daily or weekly basis, e.g. different references for working hours/non-working hours. Up to 10 Timed Actions can be programmed in the frequency converter. The Timed Action number is selected from the list when entering parameter group 23-0* from the LCP. 23-00 *ON Time* – 23-04 *Occurrence* then refer to the selected Timed Action number. Each Timed Action is divided into an ON time and an OFF time, in which two different actions may be performed.

The clock control (parameter group 0-7* *Clock Settings*) of Timed Actions can be overridden from *Timed Actions Auto* (Clock Controlled) to *Timed Actions Disabled*, *Constant OFF Actions* or *Constant ON Actions* either in 23-08 *Timed Actions Mode* or with commands applied to the digital inputs ([68] *Timed Actions Disabled*, [69] *Constant OFF Actions* or [70] *Constant ON Actions*, in parameter group 5-1* *Digital Inputs*).

Display lines 2 and 3 in the LCP show the status for Timed Actions Mode (0-23 *Display Line 2 Large* and 0-24 *Display Line 3 Large*, setting [1643] *Timed Actions Status*).

NOTE

A change in mode via the digital inputs can only take place if 23-08 *Timed Actions Mode* is set for [0] *Times Actions Auto*.

If commands are applied simultaneously to the digital inputs for Constant OFF and Constant ON, the Timed Actions mode will change to Timed Actions Auto and the two commands will be disregarded.

If 0-70 *Set Date and Time* is not set or the frequency converter is set to HAND or OFF mode (e.g. via the LCP), the Timed Actions mode will be change to *Timed Actions Disabled*.

The Timed Actions have a higher priority than the same actions/commands activated by the digital inputs or the Smart Logic Controller.

The actions programmed in Timed Actions are merged with corresponding actions from digital inputs, control word via bus and Smart Logic Controller, according to merge rules set up in parameter group 8-5*, *Digital/Bus*.

NOTE

The clock (parameter group 0-7*) must be correctly programmed for Timed Actions to function correctly.

NOTE

When mounting an Analog I/O MCB 109 option card, a battery back up of the date and time is included.

NOTE

The PC-based Configuration Tool comprise a special guide for easy programming of Timed Actions.

23-00 ON Time		
Array [10]		
Range:	Function:	
Size related*	[0 - 0]	Sets the ON time for the Timed Action.
NOTE The frequency converter has no back up of the clock function and the set date/time will reset to default (2000-01-01 00:00) after a power down unless a Real Time Clock module with back up is installed. In 0-79 <i>Clock Fault</i> it is possible to program for a Warning in case clock has not been set properly, e.g. after a power down.		

23-01 ON Action		
Select the action during ON Time. See 13-52 <i>SL Controller Action</i> for descriptions of the options.		
Option:	Function:	
	Array [10]	
[0] *	DISABLED	
[1]	No action	
[2]	Select setup 1	
[3]	Select setup 2	
[4]	Select setup 3	
[5]	Select setup 4	
[10]	Select preset ref. 0	
[11]	Select preset ref. 1	
[12]	Select preset ref. 2	
[13]	Select preset ref. 3	
[14]	Select preset ref. 4	
[15]	Select preset ref. 5	
[16]	Select preset ref. 6	
[17]	Select preset ref. 7	
[18]	Select ramp 1	
[19]	Select ramp 2	
[22]	Run	
[23]	Run reverse	
[24]	Stop	
[26]	DC brake	
[27]	Coast	
[28]	Freeze output	
[29]	Start timer 0	

[30]	Start timer 1	
[31]	Start timer 2	
[32]	Set dig. out. A low	
[33]	Set dig. out. B low	
[34]	Set dig. out. C low	
[35]	Set dig. out. D low	
[36]	Set dig. out. E low	
[37]	Set dig. out. F low	
[38]	Set dig. out. A high	
[39]	Set dig. out. B high	
[40]	Set dig. out. C high	
[41]	Set dig. out. D high	
[42]	Set dig. out. E high	
[43]	Set dig. out. F high	
[50]	Night Action	
[51]	Day Action	
[60]	Reset counter A	
[61]	Reset counter B	
[70]	Start timer 3	
[71]	Start timer 4	
[72]	Start timer 5	
[73]	Start timer 6	
[74]	Start timer 7	

23-02 OFF Time

Array [10]

Range: [0 - 0] **Function:** Sets the OFF time for the Timed Action.

Size related*

NOTE
The frequency converter has no back up of the clock function and the set date/time will reset to default (2000-01-01 00:00) after a power down unless a Real Time Clock module with back up is installed. In 0-79 Clock Fault it is possible to program for a Warning in case clock has not been set properly, e.g. after a power down.

[12]	Select preset ref. 2	
[13]	Select preset ref. 3	
[14]	Select preset ref. 4	
[15]	Select preset ref. 5	
[16]	Select preset ref. 6	
[17]	Select preset ref. 7	
[18]	Select ramp 1	
[19]	Select ramp 2	
[22]	Run	
[23]	Run reverse	
[24]	Stop	
[26]	DC brake	
[27]	Coast	
[28]	Freeze output	
[29]	Start timer 0	
[30]	Start timer 1	
[31]	Start timer 2	
[32]	Set dig. out. A low	
[33]	Set dig. out. B low	
[34]	Set dig. out. C low	
[35]	Set dig. out. D low	
[36]	Set dig. out. E low	
[37]	Set dig. out. F low	
[38]	Set dig. out. A high	
[39]	Set dig. out. B high	
[40]	Set dig. out. C high	
[41]	Set dig. out. D high	
[42]	Set dig. out. E high	
[43]	Set dig. out. F high	
[50]	Night Action	
[51]	Day Action	
[60]	Reset counter A	
[61]	Reset counter B	
[70]	Start timer 3	
[71]	Start timer 4	
[72]	Start timer 5	
[73]	Start timer 6	
[74]	Start timer 7	

23-03 OFF Action

Select the action during OFF Time. See 13-52 SL Controller Action for descriptions of the options.

Option: **Function:**

		Array [10]
[0] *	DISABLED	
[1]	No action	
[2]	Select setup 1	
[3]	Select setup 2	
[4]	Select setup 3	
[5]	Select setup 4	
[10]	Select preset ref. 0	
[11]	Select preset ref. 1	

23-04 Occurrence		
Array [10]		
Option:	Function:	
	Select which day(s) the Timed Action applies to. Specify working/non-working days in 0-81 Working Days, 0-82 Additional Working Days and 0-83 Additional Non-Working Days.	
[0] *	All days	
[1]	Working days	
[2]	Non-working days	
[3]	Monday	
[4]	Tuesday	
[5]	Wednesday	
[6]	Thursday	
[7]	Friday	
[8]	Saturday	
[9]	Sunday	

To see an example of a reactivation test, see *Illustration 3.55*.

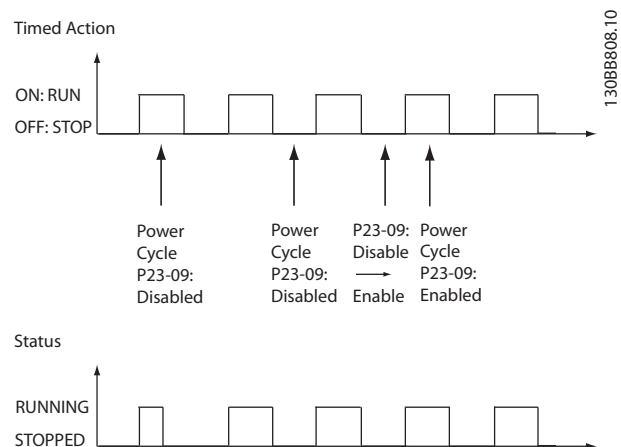

Illustration 3.55 Reactivation Test Diagram

3.18.2 23-0* Timed Actions Settings

23-08 Timed Actions Mode		
Used to enable and disable automatic timed actions.		
Option:	Function:	
[0] *	Timed Actions Auto	Enable timed actions.
[1]	Timed Actions Disabled	Disable timed actions, normal operation according to control commands.
[2]	Constant On Actions	Disable timed actions. Constant On Actions activated.
[3]	Constant Off Actions	Disable timed actions. Constant Off Actions activated.

23-09 Timed Actions Reactivation		
Option:	Function:	
[0]	Disabled	After an update of time/condition U(power cycling, setting date and time, change of summertime, change of Hand Auto mode, change of Constant ON and OFF, set-up change) all activated ON actions will be overridden to OFF actions until passing the next time for an ON action. Any OFF actions will remain unchanged.
[1] *	Enabled	After an update of time/condition On and OFF actions are immediately set to the actual time programming of ON and OFF actions.

3.18.3 23-1* Maintenance

Wear and tear calls for periodic inspection and service of elements in the application, e.g. motor bearings, feedback sensors and seals or filters. With Preventive Maintenance the service intervals may be programmed into the frequency converter. The frequency converter will give a message when maintenance is required. 20 Preventive Maintenance Events can be programmed into the frequency converter. For each Event the following must be specified:

- Maintenance item (e.g. "Motor Bearings")
- Maintenance action (e.g. "Replace")
- Maintenance Time Base (e.g. "Running Hours" or a specific date and time)
- Maintenance Time Interval or the date and time of next maintenance

NOTE

To disable a Preventive Maintenance Event the associated 23-12 Maintenance Time Base must be set to [0] Disabled.

Preventive Maintenance can be programmed from the LCP, but use of the PC-based VLT Motion Control Tool is recommended.

ID	Name	Setup 1	Setup 2	Setup 3	Setup 4
2310.0	Maintenance Item	Motor bearings	Motor bearings	Motor bearings	Motor bearings
2310.1	Maintenance Item	Motor bearings	Motor bearings	Motor bearings	Motor bearings
2310.2	Maintenance Item	Motor bearings	Motor bearings	Motor bearings	Motor bearings
2310.3	Maintenance Item	Motor bearings	Motor bearings	Motor bearings	Motor bearings
2310.4	Maintenance Item	Motor bearings	Motor bearings	Motor bearings	Motor bearings
2310.5	Maintenance Item	Motor bearings	Motor bearings	Motor bearings	Motor bearings
2310.6	Maintenance Item	Motor bearings	Motor bearings	Motor bearings	Motor bearings
2310.7	Maintenance Item	Motor bearings	Motor bearings	Motor bearings	Motor bearings
2310.8	Maintenance Item	Motor bearings	Motor bearings	Motor bearings	Motor bearings
2310.9	Maintenance Item	Motor bearings	Motor bearings	Motor bearings	Motor bearings
2310.10	Maintenance Item	Motor bearings	Motor bearings	Motor bearings	Motor bearings
2310.11	Maintenance Item	Motor bearings	Motor bearings	Motor bearings	Motor bearings
2310.12	Maintenance Item	Motor bearings	Motor bearings	Motor bearings	Motor bearings
2310.13	Maintenance Item	Motor bearings	Motor bearings	Motor bearings	Motor bearings
2310.14	Maintenance Item	Motor bearings	Motor bearings	Motor bearings	Motor bearings
2310.15	Maintenance Item	Motor bearings	Motor bearings	Motor bearings	Motor bearings
2310.16	Maintenance Item	Motor bearings	Motor bearings	Motor bearings	Motor bearings
2310.17	Maintenance Item	Motor bearings	Motor bearings	Motor bearings	Motor bearings
2310.18	Maintenance Item	Motor bearings	Motor bearings	Motor bearings	Motor bearings
2310.19	Maintenance Item	Motor bearings	Motor bearings	Motor bearings	Motor bearings
2311.0	Maintenance Action	Lubricate	Lubricate	Lubricates	Lubricate
2311.2	Maintenance Action	Lubricate	Lubricate	Lubricates	Lubricate
2311.3	Maintenance Action	Lubricate	Lubricate	Lubricates	Lubricate
2311.4	Maintenance Action	Lubricate	Lubricate	Lubricates	Lubricate
2311.5	Maintenance Action	Lubricate	Lubricate	Lubricates	Lubricate
2311.6	Maintenance Action	Lubricate	Lubricate	Lubricates	Lubricate

Illustration 3.56

The LCP indicates (with a wrench-icon and an “M”) when it is time for a Preventive Maintenance Action, and can be programmed to be indicated on a digital output in parameter group 5-3*. The Preventive Maintenance Status may be read in 16-96 Maintenance Word. A Preventive Maintenance indication can be reset from a digital input, the FC bus or manually from the LCP through 23-15 Reset Maintenance Word.

A Maintenance Log with the latest 10 loggings can be read from parameter group 18-0* and via the Alarm log key on the LCP after selecting Maintenance Log.

NOTE

The Preventive Maintenance Events are defined in a 20 element array. Hence each Preventive Maintenance Event must use the same array element index in 23-10 Maintenance Item to 23-14 Maintenance Date and Time.

23-10 Maintenance Item	
Array [20]	
Option:	Function:
	Select the item to be associated with the Preventive Maintenance Event.
[1] *	Motor bearings
[2]	Fan bearings
[3]	Pump bearings
[4]	Valve
[5]	Pressure transmitter
[6]	Flow transmitter
[7]	Temperature transm.
[8]	Pump seals
[9]	Fan belt
[10]	Filter
[11]	Drive cooling fan
[12]	System health check
[13]	Warranty
[20]	Maintenance Text 0
[21]	Maintenance Text 1
[22]	Maintenance Text 2
[23]	Maintenance Text 3
[24]	Maintenance Text 4
[25]	Maintenance Text 5

23-10 Maintenance Item	
Array [20]	
Option:	Function:
	Array with 20 elements displayed below parameter number in the display. Press [OK] and step between elements with [←], [→], [▲] and [▼].

23-11 Maintenance Action		
Array [20]		
Option:	Function:	
	Select the action to be associated with the Preventive Maintenance Event.	
[1]	Lubricate	
[2]	Clean	
[3]	Replace	
[4]	Inspect/Check	
[5]	Overhaul	
[6]	Renew	
[7]	Check	
[20]	Maintenance Text 0	
[21]	Maintenance Text 1	
[22]	Maintenance Text 2	
[23]	Maintenance Text 3	
[24]	Maintenance Text 4	
[25]	Maintenance Text 5	

23-12 Maintenance Time Base		
Array [20]		
Option:	Function:	
	Select the time base to be associated with the Preventive Maintenance Event.	
[0]	Disabled	[0] <i>Disabled</i> must be used when disabling the Preventive Maintenance Event.
[1]	Running Hours	[1] <i>Running Hours</i> is the number of hours the motor has been running. Running hours are not reset at power-on. The <i>Maintenance Time Interval</i> must be specified in <i>23-13 Maintenance Time Interval</i> .
[2]	Operating Hours	[2] <i>Operating Hours</i> is the number of hours the frequency converter has been running. Operating hours are not reset at power-on. The <i>Maintenance Time Interval</i> must be specified in <i>23-13 Maintenance Time Interval</i> .
[3]	Date & Time	[3] <i>Date & Time</i> uses the internal clock. The date and time of the next maintenance occurrence must be specified in <i>23-14 Maintenance Date and Time</i> .

23-13 Maintenance Time Interval		
Array [20]		
Range:	Function:	
1 h*	[1 - 2147483647 h]	Set the interval associated with the current Preventive Maintenance Event. This parameter is only used if [1] <i>Running Hours</i> or [2] <i>Operating Hours</i> is selected in <i>23-12 Maintenance Time Base</i> . The timer is reset from <i>23-15 Reset Maintenance Word</i> .
		Example:

23-13 Maintenance Time Interval		
Array [20]		
Range:	Function:	
	A Preventive Maintenance Event is set up Monday at 8:00. <i>23-12 Maintenance Time Base</i> is [2] <i>Operating hours</i> and <i>23-13 Maintenance Time Interval</i> is 7 x 24 hours=168 hours. Next Maintenance Event will be indicated the following Monday at 8:00. If this Maintenance Event is not reset until Tuesday at 9:00, the next occurrence will be the following Tuesday at 9:00.	

23-14 Maintenance Date and Time		
Array [20]		
Range:	Function:	
Size related*	[0 - 0]	Set the date and time for next maintenance occurrence if the Preventive Maintenance Event is based on date/time. Date format depends on the setting in <i>0-71 Date Format</i> while the time format depends on the setting in <i>0-72 Time Format</i> .
		NOTE The frequency converter has no back up of the clock function and the set date/time will reset to default (2000-01-01 00:00) after a power down. In <i>0-79 Clock Fault</i> it is possible to program for a Warning in case the clock has not been set properly, e.g. after a power down. The time set must be at least one hour from the actual time!
		NOTE When mounting an Analog I/O MCB 109 option card, a battery back up of the date and time is included.

3.18.4 23-1* Maintenance Reset

23-15 Reset Maintenance Word		
Option:	Function:	
	Set this parameter to [1] <i>Do reset</i> to reset the Maintenance Word in <i>16-96 Maintenance Word</i> and reset the message displayed in the LCP. This parameter will change back to [0] <i>Do not reset</i> when pressing [OK].	
[0] *	Do not reset	
[1]	Do reset	

NOTE

When messages are reset - Maintenance Item, Action and Maintenance Date/Time are not cancelled.

23-12 Maintenance Time Base is set to [0] Disabled.

23-16 Maintenance Text		
Array [6]		
Range:	Function:	
0 * [0 - 0]	6 individual texts (Maintenance Text 0...Maintenance Text 5) can be written for use in either 23-10 Maintenance Item or 23-11 Maintenance Action. The text is written according to the guidelines in 0-37 Display Text 1.	

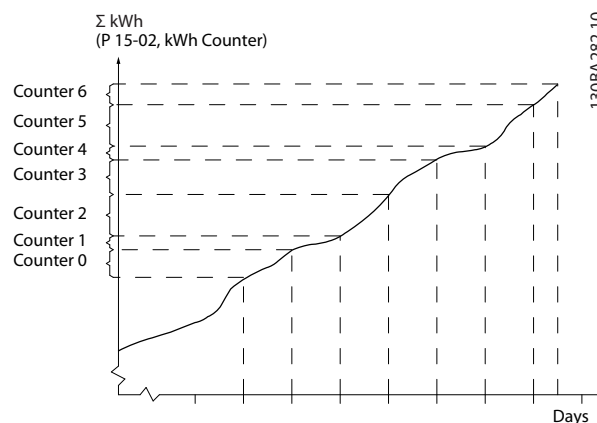

Illustration 3.57

3.18.5 23-5* Energy Log

The frequency converter is continuously accumulating the consumption of the motor controlled, based on the actual power yielded by the frequency converter.

These data can be used for an Energy Log function allowing the user to com and structure the information about the energy consumption related to time.

There are basically two functions:

- Data related to a pre-programmed period, defined by a set date and time for start
- Data related to a predefined period back in time e.g. last seven days within the pre-programmed period

For each of the above two functions, the data are stored in a number of counters allowing for selecting time frame and a split on hours, days or weeks.

The period/split (resolution) can be set in 23-50 Energy Log Resolution.

The data are based on the value registered by the kWh counter in the frequency converter. This counter value can be read in 15-02 kWh Counter containing the accumulated value since the first power up or latest reset of the counter (15-06 Reset kWh Counter).

All data for the Energy Log are stored in counters which can be read from 23-53 Energy Log.

Counter 00 always contains the oldest data. A counter covers a period from XX:00 to XX:59 if hours or 00:00 to 23:59 if days.

If logging contains either the last hours or last days, the counters shift contents at XX:00 every hour or at 00:00 every day. Counter with highest index will always be subject to update (containing data for the actual hour since XX:00 or the actual day since 00:00).

The contents of counters can be displayed as bars on LCP. Select Quick Menu, Loggings, Energy Log: Trending Continued Bin/Trending Timed Bin/Trending Comson.

23-50 Energy Log Resolution		
Option:	Function:	
		Select the desired type of period for logging of consumption. [0] Hour of Day, [1] Day of Week or [2] Day of Month. The counters contain the logging data from the programmed date/time for start (23-51 Period Start) and the numbers of hours/days as programmed for (23-50 Energy Log Resolution). The logging will start on the date programmed in 23-51 Period Start, and continue until one day/week/month has gone. [5] Last 24 Hours, [6] Last 7 Days or [7] Last 5 Weeks. The counters contain data for one day, one week or five weeks back in time and up to the actual time. The logging will start at the date programmed in 23-51 Period Start. In all cases the period split will refer to Operating Hours (time where frequency converter is powered up).
[0]	Hour of Day	
[1]	Day of Week	
[2]	Day of Month	
[5] *	Last 24 Hours	
[6]	Last 7 Days	
[7]	Last 5 Weeks	

NOTE

The frequency converter has no back up of the clock function and the set date/time will reset to default (2000-01-01 00:00) after a power down unless a Real Time Clock module with back up is installed. Consequently, the logging will be stopped until date/time is readjusted in 0-70 Set Date and Time. In 0-79 Clock Fault it is possible to program for a Warning in case clock not has been set properly, e.g. after a power down.

23-51 Period Start		
Range:	Function:	
Size related* [0 - 0]		Set the date and time at which the Energy Log starts update of the counters. First data will be stored in counter [00] and start at the time/date programmed in this parameter. Date format will depend on setting in 0-71 Date Format and time format on setting in 0-72 Time Format.

NOTE

When mounting an Analog I/O MCB 109 option card, a battery back-up of the date and time is included.

23-53 Energy Log		
Range:	Function:	
Array [31] 0 [0 - * 4294967295]		Array with a number of elements equal to the number of counters ([00]-[xx] below parameter number in display). Press [OK] and Step between elements with [▲] and [▼]. Array elements:
	<p>Illustration 3.59</p> <p>Data from latest period is stored in the counter with the highest index. At power down all counter values are stored and resumed at next power up.</p>	

NOTE

All counters are automatically reset when changing the setting in 23-50 Energy Log Resolution. At overflow, the update of the counters will stop at maximum value.

NOTE

When mounting an Analog I/O MCB 109 option card, a battery back up of the date and time is included.

23-54 Reset Energy Log		
Option:	Function:	
		Select [1] Do reset to reset all values in the Energy Log counters shown in 23-53 Energy Log. After pressing OK the setting of the parameter value will automatically change to [0] Do not reset.
[0]	Do not reset	
[1]	Do reset	

3.18.6 23-6* Trending

Trending is used to monitor a process variable over a period of time and record how often the data falls into each of ten user-defined data ranges. This is a convenient tool to get a quick overview indicating where to focus on improvement of operation.

Two sets of data for Trending can be created to make it possible to compare current values for a selected operating variable with data for a certain reference period, for the same variable. This reference period can be pre-programmed (23-63 Timed Period Start and 23-64 Timed Period Stop). The two sets of data can be read from 23-61 Continuous Bin Data (current) and 23-62 Timed Bin Data (reference).

It is possible to create Trending for following operation variables:

- Power
- Current
- Output frequency
- Motor Speed

The Trending function includes ten counters (forming a bin) for each set of data containing the numbers of registrations reflecting how often the operating variable is within each of ten pre-defined intervals. The sorting is based on a relative value of the variable.

The relative value for the operating variable is

$$\text{Actual/Rated} * 100\%$$

for Power and Current and

$$\text{Actual/Max} * 100\%$$

for Output Frequency and Motor Speed.

The size of each interval can be adjusted individually, but will default be 10% for each. Power and Current can

exceed rated value, but those registrations will be included in 90%-100% (MAX) counter.

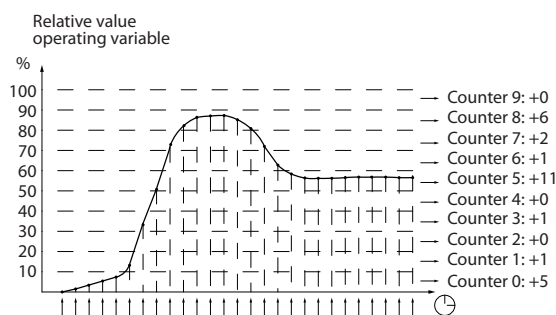

Illustration 3.60

Once a second, the value of the operating variable selected is registered. If a value has been registered to equal 13%, the counter "10% - <20%" will be updated with the value "1". If the value stays at 13% for 10s, then "10" will be added to the counter value.

The contents of counters can be displayed as bars on LCP. Select Quick Menu =>Loggings: Trending Continued Bin/Trending Timed Bin/Trending Comson.

NOTE

The counters starts counting whenever the frequency converter is powered-up. Power cycle shortly after a reset will zero the counters. EEPROM data are updated once per hour.

23-60 Trend Variable		
Option:	Function:	
		Select the desired operating variable to be monitored for Trending.
[0] *	Power [kW]	Power yielded to the motor. Reference for the relative value is the rated motor power programmed in 1-20 Motor Power [kW] or 1-21 Motor Power [HP]. Actual value can be read in 16-10 Power [kW] or 16-11 Power [hp].
[1]	Current [A]	Output current to the motor. Reference for the relative value is the rated motor current programmed in 1-24 Motor Current. Actual value can be read in 16-14 Motor current.
[2]	Frequency [Hz]	Output frequency to the motor. Reference for the relative value is the maximum output frequency programmed in 4-14 Motor Speed High Limit [Hz]. Actual value can be read in 16-13 Frequency.
[3]	Motor Speed [RPM]	Speed of the motor. Reference for relative value is the maximum motor speed programmed in 4-13 Motor Speed High Limit [RPM].

130BA281.10

23-61 Continuous Bin Data		
Range:	Function:	
0 * [0 - 4294967295]	<p>Array with 10 elements ([0]-[9] below parameter number in display). Press [OK] and step between elements with [▲] and [▼].</p> <p>10 counters with the frequency of occurrence for the operating variable monitored, sorted according to the following intervals:</p> <p style="padding-left: 40px;">Counter [0]: 0% - <10%</p> <p style="padding-left: 40px;">Counter [1]: 10% - <20%</p> <p style="padding-left: 40px;">Counter [2]: 20% - <30%</p> <p style="padding-left: 40px;">Counter [3]: 30% - <40%</p> <p style="padding-left: 40px;">Counter [4]: 40% - <50%</p> <p style="padding-left: 40px;">Counter [5]: 50% - <60%</p> <p style="padding-left: 40px;">Counter [6]: 60% - <70%</p> <p style="padding-left: 40px;">Counter [7]: 70% - <80%</p> <p style="padding-left: 40px;">Counter [8]: 80% - <90%</p> <p style="padding-left: 40px;">Counter [9]: 90% - <100% or Max</p> <p>The above minimum limits for the intervals are the default limits. These can be changed in <i>23-65 Minimum Bin Value</i>.</p> <p>Starts to count when the frequency converter is powered up for the first time. All counters can be reset to 0 in <i>23-66 Reset Continuous Bin Data</i>.</p>	

23-62 Timed Bin Data		
Range:	Function:	
0 * [0 - 4294967295]	<p>Array with 10 elements ([0]-[9] below parameter number in display). Press [OK] and step between elements with [▲] and [▼].</p> <p>10 counters with the frequency of occurrence for the operating data monitored sorted according to the intervals as for <i>23-61 Continuous Bin Data</i>.</p> <p>Starts to count at the date/time programmed in <i>23-63 Timed Period Start</i>, and stops at the time/date programmed in <i>23-64 Timed Period Stop</i>. All counters can be reset to 0 in <i>23-67 Reset Timed Bin Data</i>.</p>	

23-63 Timed Period Start		
Range:	Function:	
Size related* [0 - 0]	Set the date and time at which the Trending starts the update of the Timed Bin counters.	

23-63 Timed Period Start		
Range:	Function:	
	Date format will depend on setting in <i>0-71 Date Format</i> , and time format on setting in <i>0-72 Time Format</i> .	

NOTE

The frequency converter has no back up of the clock function and the set date/time will reset to default (2000-01-01 00:00) after a power down unless a Real Time Clock module with back up is installed. Consequently, the logging will be stopped until date/time is readjusted in *0-70 Set Date and Time*. In *0-79 Clock Fault* it is possible to program for a Warning in case clock not has been set properly, e.g. after a power down.

NOTE

When mounting an Analog I/O MCB 109 option card, a battery back up of the date and time is included.

23-64 Timed Period Stop		
Range:	Function:	
Size related* [0 - 0]	Set the date and time at which the Trend Analyses must stop update of the Timed Bin counters.	
	Date format will depend on setting in <i>0-71 Date Format</i> , and time format on setting in <i>0-72 Time Format</i> .	

NOTE

When mounting an Analog I/O MCB 109 option card, a battery back up of the date and time is included.

23-65 Minimum Bin Value		
Range:	Function:	
Size related* [0 - 100 %]	<p>Array with 10 elements ([0]-[9] below parameter number in display). Press [OK] and step between elements with [▲] and [▼].</p> <p>Set the minimum limit for each interval in <i>23-61 Continuous Bin Data</i> and <i>23-62 Timed Bin Data</i>. Example: if selecting [1] counter and changing setting from 10% to 12%, [0] counter will be based on the interval 0 - <12% and [1] counter on interval 12% - <20%.</p>	

23-66 Reset Continuous Bin Data		
Option:	Function:	
[0] *	Do not reset	Select [1] Do reset to reset all values in <i>23-61 Continuous Bin Data</i> . After pressing [OK] the setting of the parameter value will automatically change to [0] Do not reset.
[1]	Do reset	

23-67 Reset Timed Bin Data	
Option:	Function:
	Select [1] Do reset to reset all counters in 23-62 Timed Bin Data. After pressing [OK] the setting of the parameter value will automatically change to [0] Do not reset.
[0]	Do not reset
[1]	Do reset

3.18.7 23-8* Payback counter

The VLT Refrigeration Drive FC 103 includes a feature which can give a rough calculation on payback in cases where the frequency converter has been installed in an existing plant to ensure energy saving by changing from fixed to variable speed control. Reference for the savings is a set value to represent the average power yielded before the upgrade with variable speed control.

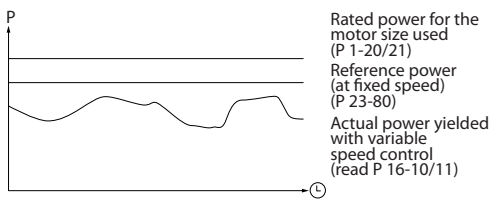

Illustration 3.61

The difference between the Reference Power at fixed speed and the Actual Power yielded with speed control represent the actual saving.

As value for the fixed speed case, the rated motor size (kW) is multiplied with a factor (set in %) representing the power produced at fixed speed. The difference between this reference power and the actual power is accumulated and stored. The difference in energy can be read in 23-83 Energy Savings.

The accumulated value for the difference in power consumption is multiplied with the energy cost in local currency and the investment is subtracted. This calculation for Cost Savings can also be read in 23-84 Cost Savings.

$$Cost\ Savings = \left\{ \sum_{t=0}^t [(Rated\ Motor\ Power * Power\ Reference\ Factor) - Actual\ Power\ Consumption] \times Energy\ Cost \right\} - Investment\ Cost$$

Break even (payback) occurs when the value read in the parameter turns from negative to positive.

Parameter for settings	Parameters for readout	
1-20 Motor Power [kW]	Energy Savings	23-83
23-80 Power Reference Factor	Actual Power	16-10/16-11
23-81 Energy Cost	Cost Savings	23-84
23-82 Investment		

Table 3.27 Parameter overview

23-80 Power Reference Factor		
Range:	Function:	
100 %* [0 - 100 %]	Set the percentage of the rated motor size (set in 1-20 Motor Power [kW] or 1-21 Motor Power [HP]) which is supposed to represent the average power yielded at the time running with fixed speed (before upgrade with variable speed control). Must be set to a value different from zero to start counting.	

23-81 Energy Cost		
Range:	Function:	
1 * [0 - 999999.99]	Set the actual cost for a kWh in local currency. If the energy cost is changed later on it will impact the calculation for the entire period.	

23-82 Investment		
Range:	Function:	
0 * [0 - 99999999]	Set the value of the investment spent on upgrading the plant with speed control, in same currency as used in 23-81 Energy Cost.	

23-83 Energy Savings		
Range:	Function:	
0 kWh* [0 - 0 kWh]	This parameter allows a readout of the accumulated difference between the reference power and the actual output power. If motor size set in hp (1-21 Motor Power [HP]), the equivalent kW value will be used for the Energy Savings.	

23-84 Cost Savings		
Range:	Function:	
0 * [0 - 2147483647]	This parameter allows a readout of the calculation based on the above equation (in local currency).	

130BA259.11

3.19 Main Menu - Pack Controller - Group 25

3.19.1 25-** Pack Controller

3

Parameters for configuring the Basic Pack Controller for sequence control of multiple compressors. For a more application oriented description and wiring examples, see section *Application Examples, Basic Pack Controller*.

To configure the Pack Controller to the actual system and the desired control strategy, it is recommended to follow the below sequence, starting with *System Settings*, parameter group 25-0*, and next *Alternation Settings*, parameter group 25-5*. These parameters can normally be set in advance.

Parameters in *Zone Settings*, 25-2*, *Staging Functions*, 25-3* and *Staging settings*, 25-4*, will often be dependent on the dynamic of the system and final adjustment to be done at the commissioning of the plant. In most cases, only 25-0* and 25-2* will need adjustment.

NOTE

The Pack Controller is supposed to operate in closed loop controlled by the built-in PI controller ([3] *Process Closed Loop* selected in 1-00 *Configuration Mode*). If [0] *Speed Open Loop* is selected in 1-00 *Configuration Mode*, all fixed speed compressors will be destaged, but the variable speed compressor will still be controlled by the frequency converter, now as an open loop configuration:

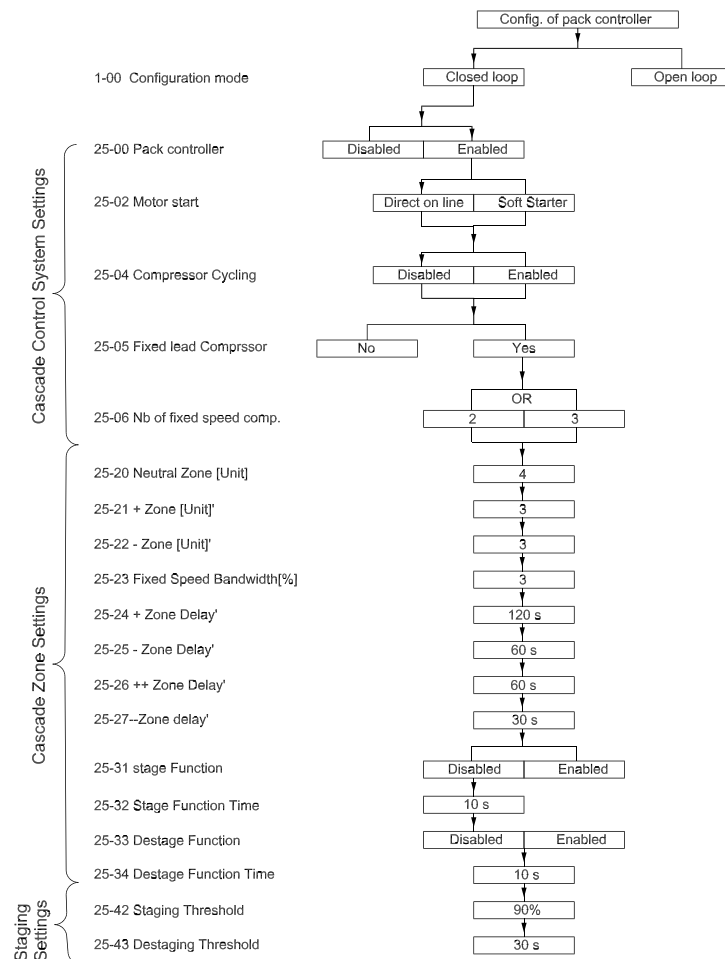

Illustration 3.62

3.19.2 25-0* System Settings

Parameters related to control principles and configuration of the system.

25-00 Cascade Controller		
Option:	Function:	
		For operation of multiple devices (compressor) systems where capacity is adapted to actual load by means of speed control combined with on/off control of the devices. For simplicity only compressor systems are described.
[0] *	Disabled	The Cascade Controller is not active. All built-in relays assigned to compressor motors in the cascade function will be de-energized. If a variable speed compressor is connected to the frequency converter directly (not controlled by a built-in relay), this compressor will be controlled as a single compressor system.
[1]	Enabled	The Cascade Controller is active and will stage/destage compressors according to load on the system.

NOTE

This parameter can only be [1] Enabled, if 22-75 Short Cycle Protection is set to [0] Disabled.

25-04 Compressor Cycling		
Option:	Function:	
		To provide equal hours of operation with fixed speed compressors, the compressor use can be cycled. The selection of compressor cycling is either "first in – last out" or equal running hours for each compressor.
[0] *	Disabled	The fixed speed compressors will be connected in the order 1 – 2 – 3 and disconnected in the order 3 – 2 – 1. (First in – last out)
[1]	Enabled	The fixed speed compressors will be connected/disconnected to have equal running hours for each compressor.

25-06 Number of Compressors		
The number of compressors connected to the Cascade Controller including the variable speed compressor. If the variable speed compressor is connected directly to the frequency converter and the other fixed speed compressors (lag compressors) are controlled by the two built in relays, three compressors can be controlled. If both the variable speed and fixed speed compressors are to be controlled by built-in relays, only two compressors can be connected.		
Range:	Function:	
2 *	[2 - 9]	If 25-06 Number of Compressors is set to 2 compressors: 1 variable speed compressor and 1 fixed speed compressor, both controlled by built -in relay.

25-06 Number of Compressors		
The number of compressors connected to the Cascade Controller including the variable speed compressor. If the variable speed compressor is connected directly to the frequency converter and the other fixed speed compressors (lag compressors) are controlled by the two built in relays, three compressors can be controlled. If both the variable speed and fixed speed compressors are to be controlled by built-in relays, only two compressors can be connected.		
Range:	Function:	
		If 25-06 Number of Compressors is set to 3 compressors: 1 variable speed compressor and 2 fixed speed compressor, all controlled by built -in relay

3.19.3 25-2* Zone Settings

Parameters for setting the zones within which the pressure will be allowed to operate before staging/destaging fixed speed compressors. Also includes various timers to stabilize control.

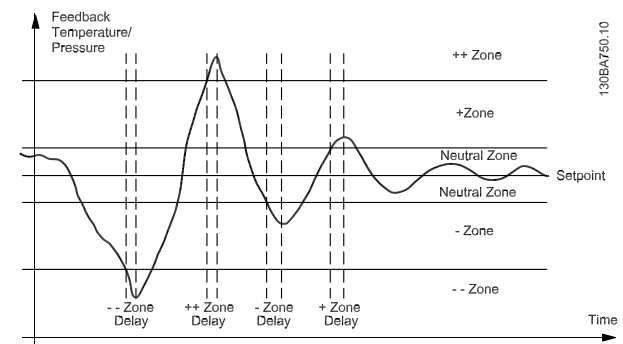

Illustration 3.63 The fixed speed compressor(s) is staged/destaged if the actual feedback enters one of the zones outside the neutral zone for more than the delay time set for this zone. If the actual feedback enters the ++zone or --zone the compressor(s) is staged/destaged at the time the first delay timer runs out. The ++zone delay should therefore always be set shorter than the + zone delay to make it active.

25-20 Neutral Zone [unit]		
Range:	Function:	
4.00*	[0-9999.99]	Set the neutral zone (NZ) to accommodate normal system pressure fluctuations. In pack control systems, to avoid frequent switching

25-20 Neutral Zone [unit]
Range:
Function:

of fixed speed compressors, the desired system pressure is typically kept within a zone rather than at a constant level. The NZ is programmed in the same unit as selected in 20-12 *Reference/Feedback Unit*. It places a zone above and below the set-point in which staging and destaging will not occur. For example, if the set-point is -20°C and the NZ is set to 4°C , a suction pressure equivalent to a temperature between -24°C and -16°C is tolerated. No staging or destaging will occur within this zone.

25-21 +Zone [unit]
Range:
Function:

3.00*	[0-9999.99]	<p>When a large and quick change in the system demand occurs, the system pressure rapidly changes and a quicker staging or destaging of a fixed speed compressor becomes necessary to match the requirement. The +Zone defines the range where the + zone delay is active.</p> <p>Setting the +Zone too close to zero could defeat the purpose with frequent staging at momentary pressure changes. Setting the +Zone too high might lead to an unacceptably high or low pressure in the system while the +Zone Delay timer (25-24 + Zone Delay) is running. The +Zone value can be optimized with increased familiarity with the system. See 25-26 ++ Zone Delay.</p> <p>To avoid unintended staging during the commissioning phase and fine tuning of the controller, initially set the +Zone to a large value beyond any expected pressure peak. This implicitly disables the override function for pressure peaks. When the fine tuning is complete, the +Zone should be set to the desired value. An initial value of 3°C is suggested.</p>
-------	-------------	---

25-22 -Zone [unit]
Range:
Function:

3.00*	[0-9999.99]	<p>When a large and quick change in the system demand occurs, the system pressure rapidly changes and a quicker staging or destaging of a fixed speed compressor becomes necessary to match the requirement. The -Zone defines the range where the - zone delay is active.</p> <p>Setting the -Zone too close to zero could defeat the purpose with frequent staging at momentary pressure changes. Setting the -Zone too high might lead to an unacceptably</p>
-------	-------------	--

25-22 -Zone [unit]
Range:
Function:

high or low pressure in the system while the 25-25 - Zone Delay is running. The -Zone value can be optimized with increased familiarity with the system. See 25-27 -- Zone Delay.

To avoid unintended staging during the commissioning phase and fine tuning of the controller, initially set the -Zone to a large value beyond any expected pressure drop. This implicitly disables the override function for pressure drops. When the fine tuning is complete, the -Zone should be set to the desired value. An initial value of 3°C is suggested.

25-23 Fixed Speed Neutral Zone [unit]
Range:
Function:

10%*	[1 - 100%]	<p>When the cascade control system is running normally and the frequency converter issues a trip alarm, it is important to maintain the system head. The Cascade Controller does this by continuing to stage/destage the fixed speed compressor on and off. Due to the fact that keeping the head at the setpoint would require frequent staging and destaging when only a fixed speed compressor is running, a wider Fixed Speed Bandwidth (FSBW) is used instead of SBW. It is possible to stop the fixed speed compressors, in case of an alarm situation, by pressing [Off] or [Hand On] or if the signal programmed for Start on digital input goes low. In case the issued alarm is a trip-lock alarm then the Cascade Controller must stop the system immediately by cutting out all the fixed speed compressors. This is basically the same as Emergency Stop (Coast/Coast inverse Command) for the Cascade Controller.</p>
------	------------	---

25-24 +Zone Delay
Range:
Function:

120 sec.*	[0-3000 sec.]	<p>Immediate staging of a fixed speed compressor is not desirable when a momentary pressure increase in the system exceeds the neutral zone (NZ). Staging is delayed by the length of time programmed. If the pressure drops to within the NZ before the timer has elapsed, the timer is reset and no staging occurs.</p>
-----------	---------------	---

25-25 -Zone Delay
Range:
Function:

60 sec.*	[0-3000 sec.]	<p>Immediate destaging of a fixed speed compressor is not desirable when a momentary pressure drop in the system exceeds the neutral zone (NZ). Destaging is</p>
----------	---------------	--

25-25 --Zone Delay		
Range:	Function:	
		delayed by the length of time programmed. If the pressure increases to within the NZ before the timer has elapsed, the timer is reset and no destaging occurs.

25-26 ++Zone Delay		
Range:	Function:	
60 sec.*	[0 – 300 sec.]	Staging a fixed speed compressor creates a momentary pressure peak in the system, which might exceed the sum of the neutral zone and the +zone. It is not desirable to destage a compressor in response to a staging pressure peak. The ++Zone Delay can be programmed to prevent staging until the system pressure has stabilized and normal control established. Set the timer to a value that allows the system to stabilize after staging. On the other hand the +Zone delay might be too long to react on a high pressure peak why the ++ zone delay always should be shorter than + zone delay. The 60s factory setting is appropriate in most applications. In highly dynamic system a shorter time may be desirable.

25-27 --Zone Delay		
Range:	Function:	
30 sec.*	[0 – 300 sec.]	Destaging a fixed speed compressor creates a momentary pressure drop in the system, which might exceed the sum of the neutral zone and the -zone. It is not desirable to stage a compressor in response to a destaging pressure drop. The --Zone Delay can be programmed to prevent staging until the system pressure has stabilized and normal control established. Set the timer to a value that allows the system to stabilize after destaging. On the other hand the +Zone delay might be too long to react on a high pressure peak why the -- zone delay always should be shorter than - zone delay. The 30s factory setting is appropriate in most applications. In highly dynamic system a shorter time may be desirable.

3.19.4 25-3* Staging Functions

Parameters for setting the Staging and Destaging functions used to avoid frequent staging and destaging of fixed speed compressors.

25-31 Stage Function		
Option:	Function:	
[0] *	Disabled	
[1]	Enabled	If the Stage Function is set to [0] Disabled, 25-32 Stage Function Time, will not be activated.

25-32 Stage Function Time		
Range:	Function:	
15 sec.*	[0 – 300 sec.]	The Stage Function Time is programmed to avoid frequent staging of the fixed speed compressors. The Stage Function Time starts if it is [1] Enabled by 25-31 Stage Function, and when the variable speed compressor is running at Motor Speed High Limit, 4-13 Motor Speed High Limit [RPM] or 4-14 Motor Speed High Limit [Hz] (or at 4-11 Motor Speed Low Limit [RPM] or 4-12 Motor Speed Low Limit [Hz] if 7-30 Process PID Normal/Inverse Control is programmed to Inverse), with at least one fixed speed compressor in the stop position. When the programmed value of the timer expires, a fixed speed compressor is staged.

25-33 Destage Function		
Option:	Function:	
[0] *	Disabled	
[1]	Enabled	The Destage Function ensures that the lowest numbers of compressors are running to save energy. If the Destage Function is set to [0] Disabled, 25-34 Destage Function Time will not be activated.

25-34 Destage Function Time		
Range:	Function:	
15 sec.*	[0 – 300 sec.]	<p>The Destage Function Timer is programmable to avoid frequent staging/destaging of the fixed speed compressors. The Destage Function Time starts when the adjustable speed compressor is running at 4-11 Motor Speed Low Limit [RPM] or 4-12 Motor Speed Low Limit [Hz] (or 4-13 Motor Speed High Limit [RPM] or 4-14 Motor Speed High Limit [Hz] if is programmed to Inverse), with one or more fixed speed compressors in operation and system requirements satisfied. In this situation, the adjustable speed compressor contributes little to the system. When the programmed value of the timer expires, a stage is removed.</p> <p style="text-align: center;">Illustration 3.64</p>

3.19.5 25-4* Staging Settings

Parameters determining conditions for staging/destaging the compressors.

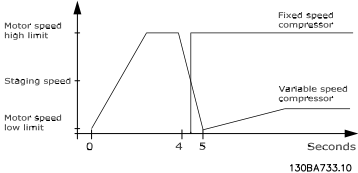
25-42 Staging Threshold		
Range:	Function:	
90%* [0 – 100%]	<p>When adding a fixed speed compressor, in order to prevent an overshoot of pressure, the variable speed compressor ramps down to a lower speed. When the variable speed compressor reaches the “Staging Speed” the fixed speed compressor is staged on. The Staging Threshold is used to calculate the speed of the variable speed compressor when the “cut-in point” of the fixed speed compressor occurs. The calculation of the Staging Threshold is the ratio of 4-11 Motor Speed Low Limit [RPM] or 4-12 Motor Speed Low Limit [Hz] to 4-13 Motor Speed High Limit [RPM] or 4-14 Motor Speed High Limit [Hz] expressed in percent.</p> <p>Staging Threshold must range from</p> $\eta_{STAGE\%} = \frac{\eta_{LOW}}{\eta_{HIGH}} \times 100\%$ <p>to 100%, where η_{LOW} is Motor Speed Low Limit and η_{HIGH} is Motor Speed High Limit.</p>  <p style="text-align: right;">130BA733.10</p>	
Illustration 3.65		

25-43 Destaging Threshold		
Range:	Function:	
50%* [0 – 100%]	<p>When removing a fixed speed compressor, in order to prevent an undershoot of pressure, the variable speed compressor ramps up to a higher speed. When the variable speed compressor reaches the “Destaging Speed” the fixed speed compressor is destaged. The Destaging Threshold is used to calculate the speed of the variable speed compressor when the destaging of the fixed speed compressor occurs. The calculation of the Destaging Threshold is the ratio of 4-11 Motor Speed Low Limit [RPM] or 4-12 Motor Speed Low Limit [Hz] to 4-13 Motor Speed High Limit [RPM] or 4-14 Motor Speed High Limit [Hz] expressed in percent.</p> <p>Destaging Threshold must range from</p> $\eta_{STAGE\%} = \frac{\eta_{LOW}}{\eta_{HIGH}} \times 100\%$ <p>to 100%, where η_{LOW} is Motor Speed Low Limit and η_{HIGH} is Motor Speed High Limit.</p>	

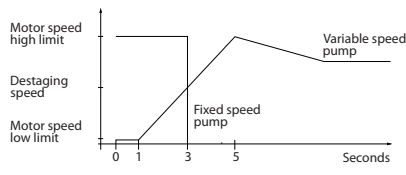
25-43 Destaging Threshold	
Range:	Function:
	 <p style="text-align: right;">130BA367.10</p>
Illustration 3.66	

25-44 Staging Speed [RPM]	
Option:	Function:
0 N/A	<p>Readout of the below calculated value for Staging Speed. When adding a fixed speed compressor, in order to prevent an overshoot of pressure, the variable speed compressor ramps down to a lower speed. When the variable speed compressor reaches the “Staging Speed” the fixed speed compressor is staged on. Staging Speed calculation is based on 25-42 Staging Threshold and 4-13 Motor Speed High Limit [RPM].</p> <p>Staging Speed is calculated with the following formula:</p> $\eta_{STAGE} = \eta_{HIGH} \frac{\eta_{STAGE\%}}{100}$ <p>where η_{HIGH} is Motor Speed High Limit and $\eta_{STAGE100\%}$ is the value of Staging Threshold.</p>

25-45 Staging Speed [Hz]	
Option:	Function:
0 N/A	<p>Readout of the below calculated value for Staging Speed When adding a fixed speed compressor, in order to prevent an overshoot of pressure, the variable speed compressor ramps down to a lower speed. When the variable speed compressor reaches the “Staging Speed” the fixed speed compressor is staged on. Staging Speed calculation is based on 25-42 Staging Threshold and 4-14 Motor Speed High Limit [Hz].</p> <p>Staging Speed is calculated with the following formula:</p> $\eta_{STAGE} = \eta_{HIGH} \frac{\eta_{STAGE\%}}{100}$ <p>where η_{HIGH} is Motor Speed High Limit and $\eta_{STAGE100\%}$ is the value of Staging Threshold.</p>

25-46 Destaging Speed [RPM]	
Option:	Function:
0 N/A	<p>Readout of the below calculated value for Destaging Speed. When removing a fixed speed compressor, in order to prevent an undershoot of pressure, the variable speed compressor ramps up to a higher speed. When the variable speed compressor reaches the “Destaging Speed” the fixed speed compressor is destaged. Destaging Speed is calculated based on</p>

25-46 Destaging Speed [RPM]

Option: Function:

25-43 Destaging Threshold and 4-13 Motor Speed High Limit [RPM].

Destaging Speed is calculated with the following formula:

$$n_{DESTAGE} = n_{HIGH} \frac{n_{DESTAGE\%}}{100}$$

where n_{HIGH} is Motor Speed High Limit and $n_{DESTAGE100\%}$ is the value of Destaging Threshold.

25-47 Destaging Speed [Hz]

Option: Function:

Readout of the below calculated value for Destaging Speed. When removing a fixed speed compressor, in order to prevent an undershoot of pressure, the variable speed compressor ramps up to a higher speed. When the variable speed compressor reaches the "Destaging Speed" the fixed speed compressor is destaged.

Destaging Speed is calculated based on 25-43 Destaging Threshold and 4-14 Motor Speed High Limit [Hz]

Destaging Speed is calculated with the following formula:

$$n_{DESTAGE} = n_{HIGH} \frac{n_{DESTAGE\%}}{100}$$

where n_{HIGH} is Motor Speed High Limit and $n_{DESTAGE100\%}$ is the value of Destaging Threshold.

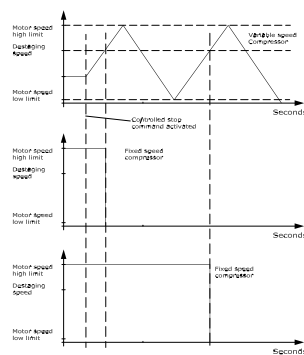

Illustration 3.67

3.19.6 25-8* Status

Readout parameters informing about the operating status of the pack controller and the compressors controlled.

25-80 Pack Status

Option: Function:

	Read out of the status of the Pack Controller.
Disabled	Pack Controller is disabled (25-00 Pack Controller).
Emergency	All compressors have been stopped by means of a Coast/Coast inverse or an External Interlock command applied to the frequency converter.

25-80 Pack Status

Option: Function:

Off	All compressors have been stopped by means of a Stop command applied to the frequency converter.
In Open Loop	1-00 Configuration Mode has been set for [0] Open Loop. All fixed speed compressors are stopped. The variable speed compressor will continue to run.
Frozen	Staging/destaging of compressors has been locked and reference locked.
Jogging	All fixed speed compressors are stopped. When stopped, the variable speed compressor will run at jog speed.
Running	A Start command is applied to the frequency converter and the Pack controller is controlling the compressors.
Running FSBW	The frequency converter is tripped off and the Pack Controller is controlling the fixed speed compressors based on 4-14 Motor Speed High Limit [Hz].
Staging	The Pack Controller is staging fixed speed compressors.
Destaging	The Pack Controller is destaging fixed speed compressors.
Lead Not Set	No compressor available to be assigned as variable speed compressor.

25-81 Compressor Status

Option: Function:

	Compressor Status shows the status for the number of compressors selected in 25-06 Number of Compressors. It is a readout of the status for each of the compressors showing a string, which consists of compressor number and the current status of the compressor. Example: Readout is with the abbreviation like "1:D 2:O" This means that compressor 1 is running and speed controlled by the frequency converter and compressor 2 is stopped.
[X] Disabled	The compressor is interlocked either via 25-90 Compressor Interlock, or signal on a digital input programmed for Compressor (number on compressor) Interlock in Digital Inputs, parameter group 5-1*. Can only refer to fixed speed compressors.
[O] Off	Stopped by the cascade controller (but not interlocked).
[D] Running on Frequency Converter	Variable speed compressor, regardless if connected directly or controlled via relay in the frequency converter.
[R] Running on Mains	Running on mains. Fixed speed compressor running.

25-82 Lead Compressor

Option: **Function:**

0	N/A	Readout parameter for the actual variable speed compressor in the system. The Lead Compressor parameter is updated to reflect the current variable speed compressor in the system when an alternation takes place. If no lead compressor is selected (Cascade Controller disabled or all compressors interlocked) the display will show NONE.
---	-----	---

25-83 Relay Status

Array [2]

On		
Off		Read out of the status for each of the relays assigned to control the compressors. Every element in the array represents a relay. If a relay is activated, the corresponding element is set to "On". If a relay is deactivated, the corresponding element is set to "Off".

25-84 Compressor ON Time

Array [2]

0	[0 – 2147483647 h]	Readout of the value for Compressor ON Time. The Cascade Controller has set counters for the compressors and for the relays that control the compressors. Compressor ON Time monitors the "operating hours" of each compressor. The value of each Compressor ON Time counter can be reset to 0 by writing in the parameter, e.g. if the compressor is replaced in case of service.
---	--------------------	--

25-85 Relay ON Time

Array [2]

0	[0 – 2147483647 h]	Readout of the value for Relay ON time. The Cascade Controller has set counters for the compressors and for the relays that control the compressors. Compressor cycling is always done based on the relay counters, otherwise it would always use the new compressor if a compressor is replaced and its value in <i>25-84 Compressor ON Time</i> counter is reset. In order to use <i>25-04 Compressor Cycling</i> , the Cascade Controller is monitoring the Relay ON time.
---	--------------------	---

25-86 Reset Relay Counters

Option: **Function:**

[0] *	Do not reset	
[1]	Do reset	Resets all elements in <i>25-85 Relay ON Time</i> .

3.19.7 25-9* Service

Parameters used in case of service on one or more of the compressors controlled.

25-90 Compressor Interlock

Array [2]

		In this parameter, it is possible to disable one or more of the fixed lead compressors. For example, the compressor will not be selected for staging on even if it is the next compressor in the operation sequence. It is not possible to disable the lead compressor with the Compressor Interlock command. The digital input interlocks are selected as [130 – 132] <i>Compressor 1-3 Interlock</i> in <i>Digital Inputs</i> , parameter group 5-1*.
[0] *	Off	The compressor is active for staging/destaging.
[1]	On	The Compressor Interlock command is given. If a compressor is running it is immediately destaged. If the compressor is not running it is not allowed to stage on.

25-91 Manual Alternation

	Range:	Function:
0 *	[0 - par. 25-06]	Readout parameter for the actual variable speed pump in the system. The Lead Pump parameter is updated to reflect the current variable speed pump in the system when an alternation takes place. If no lead pump is selected (Cascade Controller disabled or all pumps interlocked) the display will show NONE.

3.20 Main Menu - Analog I/O Option MCB 109 - Group 26

3.20.1 Analog I/O Option MCB 109, 26-**

The Analog I/O Option MCB 109 extends the functionality of VLT Refrigeration Drive FC 103 Series frequency converters, by adding a number of additional, programmable analog inputs and outputs. This could be especially useful in Building Management System installations where the frequency converter may be used as decentral I/O, obviating the need for an outstation and thus reducing cost.

Consider the diagram:

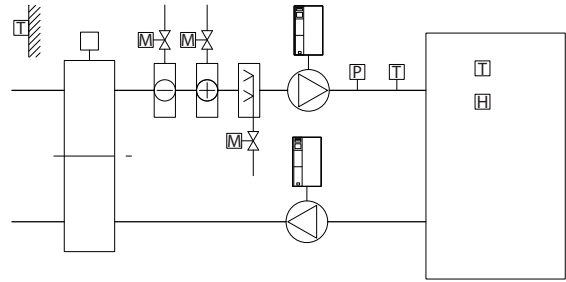

Illustration 3.68

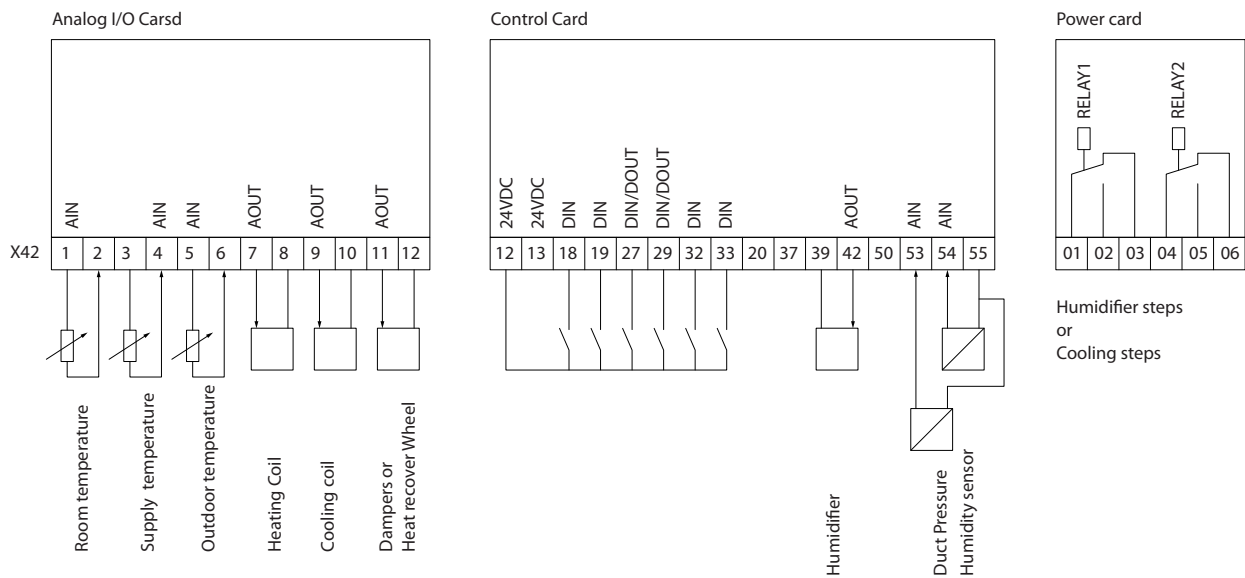

Illustration 3.69

This shows a typical Air Handling Unit (AHU). As can be seen, the addition of the Analog I/O option offers the possibility to control all of the functions from the frequency converter, such as inlet-, return- and exhaust dampers or heating/cooling coils with temperature and pressure measurements being read by the frequency converter.

NOTE

Where Live Zero Monitoring is used, it is important that any analog inputs not being used for the frequency controller, i.e. being used as of the Building Management System decentral I/O, should have their Live Zero function disabled.

NOTE

The maximum current for the analog outputs 0-10 V is 1 mA.

Terminal	Parameters	Terminal	Parameters	Terminal	Parameters
Analog inputs		Analog inputs		Relays	
X42/1	26-00, 26-1*	53	6-1*	Relay 1 Term 1, 2, 3	5-4*
X42/3	26-01, 26-2*	54	6-2*	Relay 2 Term 4, 5, 6	5-4*
X42/5	26-02, 26-3*				
Analog outputs		Analog output			
X42/7	26-4*	42	6-5*		
X42/9	26-5*				
X42/11	26-6*				

Table 3.28 Relevant Parameters

It is also possible to read the analog inputs, write to the analog outputs and control the relays, using communi-

cation via the serial bus. In this instance, these are the relevant parameters.

Terminal	Parameters	Terminal	Parameters	Terminal	Parameters
Analog inputs (read)		Analog inputs (read)		Relays	
X42/1	18-30	53	16-62	Relay 1 Term 1, 2, 3	16-71
X42/3	18-31	54	16-64	Relay 2 Term 4, 5, 6	16-71
X42/5	18-32				
Analog outputs (write)		Analog output (write)			
X42/7	18-33	42	6-53	NOTE! The relay outputs must be enabled via Control Word Bit 11 (Relay 1) and Bit 12 (Relay 2)	
X42/9	18-34				
X42/11	18-35				

Table 3.29 Relevant Parameters

Setting of on-board Real Time Clock.

The Analog I/O option incorporates a real time clock with battery back-up. This can be used as back up of the clock function included in the frequency converter as standard. See section Clock Settings, parameter group 0-7*.

The Analog I/O option can be used for the control of devices such as actuators or valves, using the Extended Closed loop facility, thus removing control from the Building Management System. See 3.16 Main Menu - Extended Closed Loop - Group 21. There are three independent closed loop PID controllers.

26-00 Terminal X42/1 Mode		
Option:	Function:	
		Terminal X42/1 can be programmed as an analog input accepting a voltage or input from either Pt1000 (1000 Ω at 0 °C) or Ni 1000 (1000 Ω at 0 °C) temperature sensors. Select the desired mode. <i>[2] Pt 1000 [°C] and [4] Ni 1000 [°C] if operating in Celsius - [3] Pt 1000 [°F] and [5] Ni 1000 [°F] if operating in Fahrenheit.</i>
		NOTE If the input is not in use, it must be set for Voltage!
		If set for temperature and used as feedback, the unit must be set for either Celsius or Fahrenheit (20-12 Reference/Feedback Unit, 21-10 Ext. 1 Ref./Feedback Unit, 21-30 Ext. 2 Ref./Feedback Unit or 21-50 Ext. 3 Ref./Feedback Unit).
[1] *	Voltage	
[2]	Pt 1000 [°C]	
[3]	Pt 1000 [°F]	
[4]	Ni 1000 [°C]	
[5]	Ni 1000 [°F]	

26-01 Terminal X42/3 Mode		
Option:	Function:	
		Terminal X42/3 can be programmed as an analog input accepting a voltage or input from either Pt 1000 or Ni 1000 temperature sensors. Select the desired mode. <i>[2] Pt 1000 [°C] and [4] Ni 1000 [°C] if operating in Celsius - [3] Pt 1000 [°F] and [5] Ni 1000 [°F] if operating in Fahrenheit.</i>
		⚠ WARNING If the input is not in use, it must be set for Voltage!
		If set for temperature and used as feedback, the unit must be set for either Celsius or Fahrenheit (20-12 Reference/Feedback Unit, 21-10 Ext. 1 Ref./Feedback Unit, 21-30 Ext. 2 Ref./Feedback Unit or 21-50 Ext. 3 Ref./Feedback Unit).
[1] *	Voltage	
[2]	Pt 1000 [°C]	
[3]	Pt 1000 [°F]	
[4]	Ni 1000 [°C]	
[5]	Ni 1000 [°F]	

26-02 Terminal X42/5 Mode		
Option:	Function:	
		Terminal X42/5 can be programmed as an analog input accepting a voltage or input from either Pt 1000 (1000 Ω at 0° C) or Ni 1000 (1000 Ω at 0° C) temperature sensors. Select the desired mode. <i>[2] Pt 1000 [°C] and [4] Ni 1000 [°C] if operating in Celsius - [3] Pt 1000 [°F] and [5] Ni 1000 [°F] if operating in Fahrenheit.</i>
		NOTE If the input is not in use, it must be set for Voltage!
		If set for temperature and used as feedback, the unit must be set for either Celsius or Fahrenheit (20-12 Reference/Feedback Unit, 21-10 Ext. 1 Ref./Feedback Unit, 21-30 Ext. 2 Ref./Feedback Unit or 21-50 Ext. 3 Ref./Feedback Unit).
[1] *	Voltage	
[2]	Pt 1000 [°C]	
[3]	Pt 1000 [°F]	
[4]	Ni 1000 [°C]	
[5]	Ni 1000 [°F]	

3.20.2 26-1* Analog Input X42/1

26-10 Terminal X42/1 Low Voltage		
Range:	Function:	
0.07 V* [0 - par. 6-31 V]	Enter the low voltage value. This analog input scaling value should correspond to the low reference/feedback value set in 26-14 Term. X42/1 Low Ref./Feedb. Value.	

26-11 Terminal X42/1 High Voltage		
Range:	Function:	
10 V* [par. 6-30 - 10 V]	Enter the high voltage value. This analog input scaling value should correspond to the high reference/feedback value set in 26-15 Term. X42/1 High Ref./Feedb. Value.	

26-14 Term. X42/1 Low Ref./Feedb. Value		
Range:	Function:	
0 * [-999999.999 - 999999.999]	Enter the analog input scaling value that corresponds to the low voltage value set in 26-10 Terminal X42/1 Low Voltage.	

26-15 Term. X42/1 High Ref./Feedb. Value		
Range:	Function:	
100 * [-999999.999 - 999999.999]	Enter the analog input scaling value that corresponds to the high voltage value set in 26-11 Terminal X42/1 High Voltage.	

26-16 Term. X42/1 Filter Time Constant		
Range:	Function:	
0.001 s* [0.001 - 10 s]	Enter the time constant. This is a first-order digital low pass filter time constant for suppressing noise in terminal X42/1. A high time constant value improves dampening but also increases the time delay through the filter.	
<p>NOTE This parameter cannot be adjusted while the motor is running.</p>		

26-17 Term. X42/1 Live Zero		
Option:	Function:	
	This parameter makes it possible to enable the Live Zero monitoring. E.g. where the analog input is a of the frequency converter control, rather than being used as of a decentral I/O system, such as a Building Management System.	
[0]	Disabled	
[1] *	Enabled	

26-25 Term. X42/3 High Ref./Feedb. Value		
Range:	Function:	
100 * [-999999.999 - 999999.999]	Enter the analog input scaling value that corresponds to the high voltage value set in 26-21 Terminal X42/3 High Voltage.	

26-26 Term. X42/3 Filter Time Constant		
Range:	Function:	
0.001 s* [0.001 - 10 s]	Enter the time constant. This is a first-order digital low pass filter time constant for suppressing noise in terminal X42/3. A high time constant value improves dampening but also increases the time delay through the filter.	
<p>NOTE This parameter cannot be adjusted while the motor is running.</p>		

26-27 Term. X42/3 Live Zero		
Option:	Function:	
	This parameter makes it possible to enable the Live Zero monitoring. E.g. where the analog input is a of the frequency converter control, rather than being used as of a decentral I/O system, such as a Building Management System.	
[0]	Disabled	
[1] *	Enabled	

3.20.3 26-2* Analog Input X42/3

26-20 Terminal X42/3 Low Voltage		
Range:	Function:	
0.07 V* [0 - par. 6-31 V]	Enter the low voltage value. This analog input scaling value should correspond to the low reference/feedback value set in 26-24 Term. X42/3 Low Ref./Feedb. Value.	

26-21 Terminal X42/3 High Voltage		
Range:	Function:	
10 V* [par. 6-30 - 10 V]	Enter the high voltage value. This analog input scaling value should correspond to the high reference/feedback value set in 26-25 Term. X42/3 High Ref./Feedb. Value.	

26-24 Term. X42/3 Low Ref./Feedb. Value		
Range:	Function:	
0 * [-999999.999 - 999999.999]	Enter the analog input scaling value that corresponds to the low voltage value set in 26-20 Terminal X42/3 Low Voltage.	

3.20.4 26-3* Analog Input X42/5

26-30 Terminal X42/5 Low Voltage		
Range:	Function:	
0.07 V* [0 - par. 6-31 V]	Enter the low voltage value. This analog input scaling value should correspond to the low reference/feedback value set in 26-34 Term. X42/5 Low Ref./Feedb. Value.	

26-31 Terminal X42/5 High Voltage		
Range:	Function:	
10 V* [par. 6-30 - 10 V]	Enter the high voltage value. This analog input scaling value should correspond to the high reference/feedback value set in 26-35 Term. X42/5 High Ref./Feedb. Value.	

26-34 Term. X42/5 Low Ref./Feedb. Value		
Range:	Function:	
0 * [-999999.999 - 999999.999]	Enter the analog input scaling value that corresponds to the low voltage value set in 26-30 Terminal X42/5 Low Voltage.	

26-35 Term. X42/5 High Ref./Feedb. Value		
Range:	Function:	
100 * [-999999.999 - 999999.999]	Enter the analog input scaling value that corresponds to the high voltage value set in 26-21 Terminal X42/3 High Voltage.	

26-36 Term. X42/5 Filter Time Constant		
Range:	Function:	
0.001 s* [0.001 - 10 s]	Enter the time constant. This is a first-order digital low pass filter time constant for suppressing noise in terminal X42/5. A high time constant value improves dampening but also increases the time delay through the filter.	
<p>NOTE This parameter cannot be adjusted while the motor is running.</p>		

26-37 Term. X42/5 Live Zero		
Option:	Function:	
	This parameter makes it possible to enable the Live Zero monitoring. E.g. where the analog input is a of the frequency converter control, rather than being used as of a decentral I/O system, such as a Building Management System.	
[0]	Disabled	
[1] *	Enabled	

3.20.5 26-4* Analog Input X42/7

26-40 Terminal X42/7 Output		
Option:	Function:	
	Set the function of terminal X42/7 as an analog voltage output.	
[0] *	No operation	
[100]	Output frequency	0-100 Hz, (0-20 mA)
[101]	Reference	Minimum reference - Maximum reference, (0-20 mA)
[102]	Feedback	-200% to +200% of 3-03 Maximum Reference, (0-20 mA)
[103]	Motor Current	0 - Inverter Max. Current (16-37 Inv. Max. Current), (0-20 mA)
[104]	Torque rel to limit	0 - Torque limit (4-16 Torque Limit Motor Mode), (0-20 mA)
[105]	Torq relate to rated	0 - Motor rated torque, (0-20 mA)
[106]	Power	0 - Motor rated power, (0-20 mA)

26-40 Terminal X42/7 Output		
Option:	Function:	
[107]	Speed	0 - Speed High Limit (4-13 Motor Speed High Limit [RPM] and 4-14 Motor Speed High Limit [Hz]), (0-20 mA)
[108]	Torque	
[109]	Max Out Freq	
[113]	Ext. Closed Loop 1	0-100%, (0-20 mA)
[114]	Ext. Closed Loop 2	0-100%, (0-20 mA)
[115]	Ext. Closed Loop 3	0-100%, (0-20 mA)
[139]	Bus ctrl.	0-100%, (0-20 mA)
[141]	Bus ctrl t.o.	0-100%, (0-20 mA)

26-41 Terminal X42/7 Min. Scale		
Range:	Function:	
0 %* [0 - 200 %]	Scale the minimum output of the selected analog signal at terminal X42/7, as a percentage of the maximum signal level. E.g. if a 0 V (or 0 Hz) is desired at 25% of the maximum output value. Then programme 25%. Scaling values up to 100% can never be higher than the corresponding setting in 26-42 Terminal X42/7 Max. Scale. See principle graph for 6-51 Terminal 42 Output Min Scale.	

26-42 Terminal X42/7 Max. Scale		
Range:	Function:	
100 %* [0 - 200 %]	Scale the maximum output of the selected analog signal at terminal X42/7. Set the value to the maximum value of the voltage signal output. Scale the output to give a voltage lower than 10 V at full scale; or 10 V at an output below 100% of the maximum signal value. If 10 V is the desired output current at a value between 0-100% of the full-scale output, programme the percentage value in the parameter, i.e. 50% = 10 V. If a voltage between 0 and 10 V is desired at maximum output, calculate the percentage as follows: $\left(\frac{10V}{\text{desired maximum voltage}} \right) \times 100\%$ i.e. $5V : \frac{10V}{5V} \times 100\% = 200\%$	

See principle graph for 6-52 Terminal 42 Output Max Scale.

26-43 Terminal X42/7 Bus Control		
Range:	Function:	
0 %* [0 - 100 %]	Holds the level of terminal X42/7 if controlled by bus.	

26-44 Terminal X42/7 Timeout Preset		
Range:	Function:	
0 %*	[0 - 100 %]	Holds the preset level of terminal X42/7. In case of a bus timeout and a timeout function is selected in 26-50 Terminal X42/9 Output the output will preset to this level.

3.20.6 26-5* Analog Input X42/9

26-50 Terminal X42/9 Output		
Option:	Function:	
		Set the function of terminal X42/9.
[0] *	No operation	
[100]	Output frequency	0-100 Hz, (0-20 mA)
[101]	Reference	Minimum reference - Maximum reference, (0-20 mA)
[102]	Feedback	-200% to +200% of 3-03 Maximum Reference, (0-20 mA)
[103]	Motor Current	0 - Inverter Max. Current (16-37 Inv. Max. Current), (0-20 mA)
[104]	Torque rel to limit	0 - Torque limit (4-16 Torque Limit Motor Mode), (0-20 mA)
[105]	Torq relate to rated	0 - Motor rated torque, (0-20 mA)
[106]	Power	0 - Motor rated power, (0-20 mA)
[107]	Speed	0 - Speed High Limit (4-13 Motor Speed High Limit [RPM] and 4-14 Motor Speed High Limit [Hz]), (0-20 mA)
[108]	Torque	
[109]	Max Out Freq	
[113]	Ext. Closed Loop 1	0 - 100%, (0-20 mA)
[114]	Ext. Closed Loop 2	0 - 100%, (0-20 mA)
[115]	Ext. Closed Loop 3	0 - 100%, (0-20 mA)
[139]	Bus ctrl.	0 - 100%, (0-20 mA)
[141]	Bus ctrl t.o.	0 - 100%, (0-20 mA)

26-51 Terminal X42/9 Min. Scale		
Range:	Function:	
0 %*	[0 - 200 %]	Scale the minimum output of the selected analog signal at terminal X42/9, as a percentage of the maximum signal level. E.g. if a 0 V is desired at 25% of the maximum output value. Then programme 25%. Scaling values up to 100% can never be higher than the corresponding setting in 26-52 Terminal X42/9 Max. Scale.

See principle graph for 6-51 Terminal 42 Output Min Scale.

26-52 Terminal X42/9 Max. Scale		
Range:	Function:	
100 %*	[0 - 200 %]	Scale the maximum output of the selected analog signal at terminal X42/9. Set the value to the maximum value of the voltage signal output. Scale the output to give a voltage lower than 10 V at full scale; or 10 V at an output below 100% of the maximum signal value. If 10 V is the desired output current at a value between 0-100% of the full-scale output, programme the percentage value in the parameter, i.e. 50% = 10 V. If a voltage between 0 and 10V is desired at maximum output, calculate the percentage as follows: i.e. $5V : \frac{10V}{5V} \times 100\% = 200\%$

See principle graph for 6-52 Terminal 42 Output Max Scale.

26-53 Terminal X42/9 Bus Control		
Range:	Function:	
0 %*	[0 - 100 %]	Holds the level of terminal X42/9 if controlled by bus.

26-54 Terminal X42/9 Timeout Preset		
Range:	Function:	
0 %*	[0 - 100 %]	Holds the preset level of terminal X42/9. In case of a bus timeout and a timeout function is selected in 26-60 Terminal X42/11 Output the output will preset to this level.

3.20.7 26-6* Analog Input X42/11

26-60 Terminal X42/11 Output		
Option:	Function:	
		Set the function of terminal X42/11.
[0] *	No operation	
[100]	Output frequency	0-100 Hz, (0-20 mA)
[101]	Reference	Minimum reference - Maximum reference, (0-20 mA)
[102]	Feedback	-200% to +200% of 3-03 Maximum Reference, (0-20 mA)
[103]	Motor Current	0 - Inverter Max. Current (16-37 Inv. Max. Current), (0-20 mA)
[104]	Torque rel to limit	0 - Torque limit (4-16 Torque Limit Motor Mode), (0-20 mA)
[105]	Torq relate to rated	0 - Motor rated torque, (0-20 mA)
[106]	Power	0 - Motor rated power, (0-20 mA)
[107]	Speed	0 - Speed High Limit (4-13 Motor Speed High Limit [RPM] and 4-14 Motor Speed High Limit [Hz]), (0-20 mA)
[108]	Torque	

26-60 Terminal X42/11 Output		
Option:	Function:	
[109]	Max Out Freq	
[113]	Ext. Closed Loop 1	0-100%, (0-20 mA)
[114]	Ext. Closed Loop 2	0-100%, (0-20 mA)
[115]	Ext. Closed Loop 3	0-100%, (0-20 mA)
[139]	Bus ctrl.	0-100%, (0-20 mA)
[141]	Bus ctrl t.o.	0-100%, (0-20 mA)

26-61 Terminal X42/11 Min. Scale		
Range:	Function:	
0 %* [0 - 200 %]	Scale the minimum output of the selected analog signal at terminal X42/11, as a percentage of the maximum signal level. E.g. if a 0 V is desired at 25% of the maximum output value. Then programme 25%. Scaling values up to 100% can never be higher than the corresponding setting in 26-62 Terminal X42/11 Max. Scale.	

See principle graph for 6-51 Terminal 42 Output Min Scale.

26-62 Terminal X42/11 Max. Scale		
Range:	Function:	
100 %* [0 - 200 %]	Scale the maximum output of the selected analog signal at terminal X42/9. Set the value to the maximum value of the voltage signal output. Scale the output to give a voltage lower than 10 V at full scale; or 10 V at an output below 100% of the maximum signal value. If 10 V is the desired output current at a value between 0-100% of the full-scale output, programme the percentage value in the parameter, i.e. 50% = 10 V. If a voltage between 0 and 10 V is desired at maximum output, calculate the percentage as follows: $\left(\frac{10V}{\text{desired maximum voltage}}\right) \times 100\%$ i.e. $5V : \frac{10V}{5V} \times 100\% = 200\%$	

See principle graph for 6-52 Terminal 42 Output Max Scale.

26-63 Terminal X42/11 Bus Control		
Range:	Function:	
0 %* [0 - 100 %]	Holds the level of terminal X42/11 if controlled by bus.	

26-64 Terminal X42/11 Timeout Preset		
Range:	Function:	
0 %* [0 - 100 %]	Holds the preset level of terminal X42/11. In case a bus time-out and a time-out function are selected, the output will preset to this level.	

3.21 Main Menu - Compressor Functions - Group 28

3.21.1 28-2* Discharge Temperature Monitor

The Discharge Temperature Monitor (DTM) can be used to prevent the discharge temperature from reaching dangerous levels.

Two temperature levels of increasing severity can be programmed. These levels are called warning level (set in 28-24 *Warning Level*) and emergency level (set in 28-24 *Warning Level*) in order of increasing severity. Each level corresponds to aicular set of preventive actions.

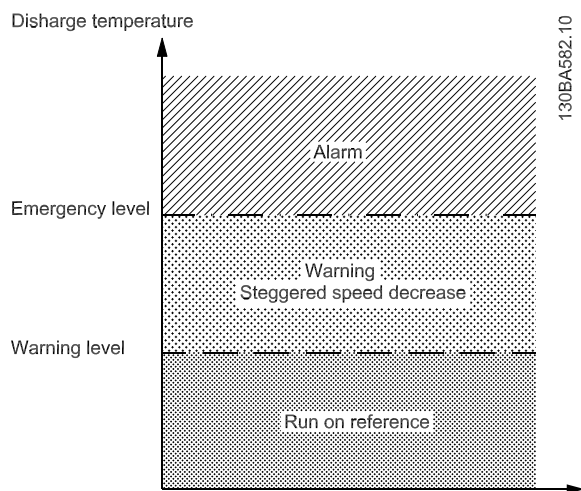

Illustration 3.70

Discharge temperatures above the Emergency level cause an alarm and an immediate trip to prevent damage to the compressor.

Normal operations apply for discharge temperatures below Warning level. The discharge temperature is passively monitored without affecting frequency converter operations.

Discharge temperatures in the range from Warning level to Emergency level trigger a warning and an action set by 28-25 *Warning Action*. The action can be None or Decrease cooling. If the action is set to Decrease cooling the cooling is decreased as a preventive action in an attempt to lower the discharge temperature.

Cooling is decreased by step-wise lowering of the shaft speed until the discharge temperature either drops below Warning level or exceeds Emergency level. Each step represents a three minute period during which the

maximum allowed shaft speed is 10 Hz lower than the previous step. The initial step occurs when the discharge temperature rises from below to above Warning level and uses the current shaft speed as basis for the 10 Hz speed reduction.

The speed steps enforce maximum shaft speeds. If the reference corresponds to a lesser speed, the reference is obeyed. If it corresponds to a higher speed, the speed is limited to the maximum shaft speed for that step.

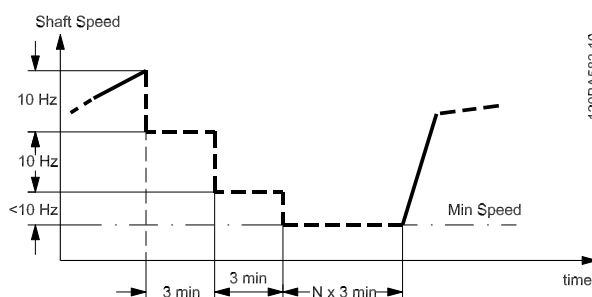

Illustration 3.71

NOTE

If the Cascade Controller is active unwanted staging or destaging may result if the Discharge Temperature Monitor reduces the speed to *Motor Speed Low Limit, 4-11 Motor Speed Low Limit [RPM] or 4-12 Motor Speed Low Limit [Hz]*.

28-20 Temperature Source

Option:	Function:
[0] *	None Selects the input terminal to which the discharge temperature measurement device is connected. No Source. The Discharge Temperature Monitor is not active.
[1]	Analog input 53 The measurement device is connected to input terminal 53. Program 6-10 Terminal 53 Low Voltage to 6-15 Terminal 53 High Ref./Feedb. Value to match the characteristics of the device.
[2]	Analog input 54 The measurement device is connected to input terminal 54. Program 6-20 Terminal 54 Low Voltage to 6-25 Terminal 54 High Ref./Feedb. Value to match the characteristics of the device.

28-21 Temperature Unit

Option:	Function:
[60] *	°C Selects the unit of the discharge temperature.
[160]	°F

28-24 Warning Level
Range: **Function:**

130 *	[10 – 28-26]	Selects the temperature at which a warning shall be issued. The action selected in <i>28-25 Warning Action</i> becomes active at this temperature. Enter the temperature measured in the unit selected in <i>28-21 Temperature Unit</i> .
-------	--------------	---

28-25 Warning Action
Option: **Function:**

		Selects the action to be taken by the frequency converter for discharge temperatures above the value programmed in <i>28-21 Temperature Unit</i> but below the value programmed in <i>28-26 Emergency Level</i> .
[0]	None	No action. Only a warning will be issued.
[1] *	Decrease cooling	A warning is issued and the motor speed is lowered in steps of 10 Hz every 3 minutes until the temperature either drops below the level programmed in <i>28-24 Warning Level</i> or exceeds the level programmed in <i>28-26 Emergency Level</i> .

28-26 Emergency Level
Range: **Function:**

145*	[par. 28-24 - 300]	Selects the temperature at which an alarm shall be issued. Enter the temperature in the unit programmed in par. 28-21 Temperature Unit.
------	--------------------	---

28-27 Discharge Temperature
Range: **Function:**

0*	[-2147483648 – 2147483648]	Returns the actual value of the discharge temperature.
----	----------------------------	--

3.21.2 28-7* Day/ Night Control

In day-night control mode compressor runs normally during day time while it runs with increased setpoint during night time. The condenser fans run normally during day time while they run with reduced maximum speed limit during night time. There are three sources of day or night indication in the frequency converter. Digital Input (parameter group 5-1*), Timed Actions (parameter group 23-*) and LON Bus (parameter group 28-7*).

The Day-Night control action is active if *20-25 Setpoint Type* is set to 'Fixed with Night Setback'.

28-71 Day/ Night Bus Indicator
Range: **Function:**

0*	[0 - 1]	This parameter is written by the LON Bus periodically to indicate day or night. This is a read only parameter on LCP. 1 indicates night and 0 indicates day.
----	---------	--

28-72 Enable Day/ Night via Bus
Range: **Function:**

0*	[0 - 1]	This parameter enables or disables usage of <i>28-71 Day/Night Bus Indicator</i> . If this parameter is set to [0] <i>Disable</i> then the value in <i>28-71 Day/Night Bus Indicator</i> is discarded in day-night control. If this parameter is set to [1] <i>Enable</i> then the value in <i>28-71 Day/Night Bus Indicator</i> is considered in day-night control. If the day night signal is not received via bus the day/night indication can be programmed via digital inputs.
----	---------	---

28-73 Night Setback
Range: **Function:**

0*	[0 – (3-03 – 3-02)]	This parameter defines the value by which the compressor setpoint should be increased, during night.
----	----------------------	--

28-74 Night Speed Drop
Range: **Function:**

0*	[0 – (4-13 – 4-11)]	This parameter defines the value by which the maximum speed limit of the condenser fans should be lowered during night. The range of the value is from 0 to difference of <i>4-13 Motor Speed High Limit [RPM]</i> and <i>4-11 Motor Speed Low Limit [RPM]</i> .
----	----------------------	--

28-75 Night Speed Drop Override
Range: **Function:**

0*	[-1000000.000 – 1000000.000]	This parameter defines a limit on the condenser feedback (pressure) when night action is active. If condenser feedback is more than the value set in this parameter, then night action is deactivated (if already active) and day action is activated. A value of zero in this parameter means that night speed drop will be active independent of condenser pressure.
----	-------------------------------	--

3.21.3 28-8* P0 Optimization

The FC 103 supports the VLT Refrigeration Drive P0 Optimisation feature. This enables automatic adaptation of the suction pressure to optimally match the system's actual load.

To enable this function *20-25 Setpoint Type* must be set to "Floating". The frequency converter now accepts setpoint changes from the LON bus. The frequency converter assures that the set minimum and maximum limits for the feedback suction pressure are observed.

28-81 dP0 Offset
Range: **Function:**

-999999.9 - 999999.9	[]	The value of the parameter is added to the setpoint provided <i>20-25 Setpoint Type</i> is programmed to [2] <i>Floating</i> . The unit of the parameter is shown as Kelvin indicating that
----------------------	-----	---

28-81 dP0 Offset	
Range:	Function:
	the feedback is assumed to be a pressure converted to an equivalent temperature via the pressure-to-temperature conversion functions selectable in <i>20-01 Feedback 1 Conversion</i> , <i>20-03 Feedback 2 Source</i> or <i>20-06 Feedback 3 Source</i> .

28-82 P0	
Range:	Function:
-999999.999 - 999999.999	□ The feedback pressure measured on the analogue inputs, converted to an equivalent temperature.

28-83 P0 Setpoint	
Range:	Function:
-999999.999 - 999999.999	□ The setpoint of the frequency converter excluding any offset programmed into <i>28-81 dP0 Offset</i> .

28-84 P0 Reference	
Range:	Function:
-999999.999 - 999999.999	□ The sum of the setpoint of the frequency converter (<i>28-83 P0 Setpoint</i>) and the offset programmed into <i>28-81 dP0 Offset</i> .

28-85 P0 Minimum Reference	
Range:	Function:
-999999 - 999999	□ The largest negative offset value that can be programmed into <i>28-81 dP0 Offset</i> without exceeding the minimum reference value programmed into <i>3-02 Minimum Reference</i> . The value is rounded to the nearest larger integer. If a numerically larger value is entered the sum of the offset and the setpoint is clipped to the value of <i>3-02 Minimum Reference</i> .

28-86 P0 Maximum Reference	
Range:	Function:
-999999 - 999999	□ The largest positive offset value that can be programmed into <i>28-81 dP0 Offset</i> without exceeding the maximum reference value programmed into <i>3-03 Maximum Reference</i> . The value is rounded to the nearest smaller integer. If a numerically larger value is entered the sum of the offset and the setpoint is clipped to the value of <i>3-03 Maximum Reference</i> .

28-90 injection_on	
Range:	Function:
0*	[0 - 1] This parameter is read by LON Bus to convey the Injection ON/OFF signal to the case controllers. If this parameter value is 0 then it means Injection OFF, if the parameter has a value 1 then it means Injection ON.

28-91 Delayed Compressor Start	
Range:	Function:
0*	[0 - 1] If this parameter is set to 1, Delayed start of compressor is controlled by Injection Control feature in association with <i>1-71 Start Delay</i> . If it is set to 0 then Delayed start of compressor is controlled only by <i>1-71 Start Delay</i> . If <i>28-91 Delayed Compressor Start</i> set to 1 and injection is OFF; start of compressor is delayed by amount of time set in <i>1-71 Start Delay</i> . If <i>28-91 Delayed Compressor Start</i> set to 1 and injection is ON then start of compressor is not delayed. If <i>28-91</i> is set to 0, Injection Controller feature will not interfere in delaying start of compressor. Delayed start of compressor is not active during Short Cycle protection.

3.21.4 28-9* Injection Control

The injection ON/OFF signal is a forced close signal to the case controllers (to turn display cases off). The signal is distributed by following means- hardwired through a digital output/relay or soft wired via bus by gateway or system manager.

4 Parameter Lists

4.1 Parameter Options

4.1.1 Default settings

Changes during operation:

"TRUE" means that the parameter can be changed while the frequency converter is in operation and "FALSE" means that the frequency converter must be stopped before a change can be made.

4-Set-up:

'All set-up': the parameter can be set individually in each of the four set-ups, i. e. one single parameter can have four different data values.

'1 set-up': data value will be the same in all set-ups.

SR:

Size related

N/A:

No default value available.

Conversion index:

This number refers to a conversion figure used when writing or reading by means of a frequency converter.

Conv. index	100	75	74	70	67	6	5	4	3	2	1	0	-1	-2	-3	-4	-5	-6
Conv. factor	1	3600000	3600	60	1/60	100000	10000	10000	1000	100	10	1	0.1	0.01	0.001	0.000	0.00001	0.00000
						0	0									1		1

Table 4.1

Data type	Description	Type
2	Integer 8	Int8
3	Integer 16	Int16
4	Integer 32	Int32
5	Unsigned 8	Uint8
6	Unsigned 16	Uint16
7	Unsigned 32	Uint32
9	Visible String	VisStr
33	Normalized value 2 bytes	N2
35	Bit sequence of 16 boolean variables	V2
54	Time difference w/o date	TimD

Table 4.2

4.1.2 0-** Operation and Display

4

Par. No. #	Parameter description	Default value	4-set-up	Change during operation	Conversion index	Type
0-0* Basic Settings						
0-01	Language	[0] English	1 set-up	TRUE	-	UInt8
0-02	Motor Speed Unit	[1] Hz	2 set-ups	FALSE	-	UInt8
0-03	Regional Settings	ExpressionLimit	2 set-ups	FALSE	-	UInt8
0-04	Operating State at Power-up	[0] Resume	All set-ups	TRUE	-	UInt8
0-05	Local Mode Unit	[0] As Motor Speed Unit	2 set-ups	FALSE	-	UInt8
0-1* Set-up Operations						
0-10	Active Set-up	[1] Set-up 1	1 set-up	TRUE	-	UInt8
0-11	Programming Set-up	[9] Active Set-up	All set-ups	TRUE	-	UInt8
0-12	This Set-up Linked to	[0] Not linked	All set-ups	FALSE	-	UInt8
0-13	Readout: Linked Set-ups	0 N/A	All set-ups	FALSE	0	UInt16
0-14	Readout: Prog. Set-ups / Channel	0 N/A	All set-ups	TRUE	0	Int32
0-2* LCP Display						
0-20	Display Line 1.1 Small	ExpressionLimit	All set-ups	TRUE	-	UInt16
0-21	Display Line 1.2 Small	ExpressionLimit	All set-ups	TRUE	-	UInt16
0-22	Display Line 1.3 Small	ExpressionLimit	All set-ups	TRUE	-	UInt16
0-23	Display Line 2 Large	ExpressionLimit	All set-ups	TRUE	-	UInt16
0-24	Display Line 3 Large	ExpressionLimit	All set-ups	TRUE	-	UInt16
0-25	My Personal Menu	ExpressionLimit	1 set-up	TRUE	0	UInt16
0-3* LCP Custom Readout						
0-30	Custom Readout Unit	[1] %	All set-ups	TRUE	-	UInt8
0-31	Custom Readout Min Value	ExpressionLimit	All set-ups	TRUE	-2	Int32
0-32	Custom Readout Max Value	100 CustomReadoutUnit	All set-ups	TRUE	-2	Int32
0-37	Display Text 1	0 N/A	1 set-up	TRUE	0	VisStr[25]
0-38	Display Text 2	0 N/A	1 set-up	TRUE	0	VisStr[25]
0-39	Display Text 3	0 N/A	1 set-up	TRUE	0	VisStr[25]
0-4* LCP Keypad						
0-40	[Hand on] Key on LCP	[1] Enabled	All set-ups	TRUE	-	UInt8
0-41	[Off] Key on LCP	[1] Enabled	All set-ups	TRUE	-	UInt8
0-42	[Auto on] Key on LCP	[1] Enabled	All set-ups	TRUE	-	UInt8
0-43	[Reset] Key on LCP	[1] Enabled	All set-ups	TRUE	-	UInt8
0-5* Copy/Save						
0-50	LCP Copy	[0] No copy	All set-ups	FALSE	-	UInt8
0-51	Set-up Copy	[0] No copy	All set-ups	FALSE	-	UInt8
0-6* Password						
0-60	Main Menu Password	100 N/A	1 set-up	TRUE	0	Int16
0-61	Access to Main Menu w/o Password	[0] Full access	1 set-up	TRUE	-	UInt8
0-65	Personal Menu Password	200 N/A	1 set-up	TRUE	0	Int16
0-66	Access to Personal Menu w/o Password	[0] Full access	1 set-up	TRUE	-	UInt8
0-67	Bus Password Access	0 N/A	All set-ups	TRUE	0	UInt16
0-7* Clock Settings						
0-70	Set Date and Time	ExpressionLimit	All set-ups	TRUE	0	TimeOfDay
0-71	Date Format	ExpressionLimit	1 set-up	TRUE	-	UInt8
0-72	Time Format	ExpressionLimit	1 set-up	TRUE	-	UInt8
0-74	DST/Summertime	[0] Off	1 set-up	TRUE	-	UInt8
0-76	DST/Summertime Start	ExpressionLimit	1 set-up	TRUE	0	TimeOfDay
0-77	DST/Summertime End	ExpressionLimit	1 set-up	TRUE	0	TimeOfDay

Par. No. #	Parameter description	Default value	4-set-up	Change during operation	Conversion index	Type
0-79	Clock Fault	[0] Disabled	1 set-up	TRUE	-	UInt8
0-81	Working Days	ExpressionLimit	1 set-up	TRUE	-	UInt8
0-82	Additional Working Days	ExpressionLimit	1 set-up	TRUE	0	TimeOfDay
0-83	Additional Non-Working Days	ExpressionLimit	1 set-up	TRUE	0	TimeOfDay
0-89	Date and Time Readout	0 N/A	All set-ups	TRUE	0	VisStr[25]

Table 4.3

4.1.3 1-** Load/Motor

Par. No. #	Parameter description	Default value	4-set-up	Change during operation	Conversion index	Type
1-0* General Settings						
1-00	Configuration Mode	ExpressionLimit	All set-ups	TRUE	-	UInt8
1-03	Torque Characteristics	[0] Compressor CT	All set-ups	TRUE	-	UInt8
1-1* Motor Selection						
1-10	Motor Construction	[0] Asynchron	All set-ups	FALSE	-	UInt8
1-1* VVC+ PM						
1-14	Damping Gain	120 %	All set-ups	TRUE	0	Int16
1-15	Low Speed Filter Time Const.	ExpressionLimit	All set-ups	TRUE	-2	UInt16
1-16	High Speed Filter Time Const.	ExpressionLimit	All set-ups	TRUE	-2	UInt16
1-17	Voltage filter time const.	ExpressionLimit	All set-ups	TRUE	-3	UInt16
1-2* Motor Data						
1-20	Motor Power [kW]	ExpressionLimit	All set-ups	FALSE	1	UInt32
1-21	Motor Power [HP]	ExpressionLimit	All set-ups	FALSE	-2	UInt32
1-22	Motor Voltage	ExpressionLimit	All set-ups	FALSE	0	UInt16
1-23	Motor Frequency	ExpressionLimit	All set-ups	FALSE	0	UInt16
1-24	Motor Current	ExpressionLimit	All set-ups	FALSE	-2	UInt32
1-25	Motor Nominal Speed	ExpressionLimit	All set-ups	FALSE	67	UInt16
1-26	Motor Cont. Rated Torque	ExpressionLimit	All set-ups	FALSE	-1	UInt32
1-28	Motor Rotation Check	[0] Off	All set-ups	FALSE	-	UInt8
1-29	Automatic Motor Adaptation (AMA)	[0] Off	All set-ups	FALSE	-	UInt8
1-3* Adv. Motor Data						
1-30	Stator Resistance (Rs)	ExpressionLimit	All set-ups	FALSE	-4	UInt32
1-31	Rotor Resistance (Rr)	ExpressionLimit	All set-ups	FALSE	-4	UInt32
1-35	Main Reactance (Xh)	ExpressionLimit	All set-ups	FALSE	-4	UInt32
1-36	Iron Loss Resistance (Rfe)	ExpressionLimit	All set-ups	FALSE	-3	UInt32
1-37	d-axis Inductance (Ld)	ExpressionLimit	All set-ups	FALSE	-6	Int32
1-39	Motor Poles	ExpressionLimit	All set-ups	FALSE	0	UInt8
1-40	Back EMF at 1000 RPM	ExpressionLimit	All set-ups	FALSE	0	UInt16
1-5* Load Indep. Setting						
1-50	Motor Magnetisation at Zero Speed	100 %	All set-ups	TRUE	0	UInt16
1-51	Min Speed Normal Magnetising [RPM]	ExpressionLimit	All set-ups	TRUE	67	UInt16
1-52	Min Speed Normal Magnetising [Hz]	ExpressionLimit	All set-ups	TRUE	-1	UInt16
1-58	Flystart Test Pulses Current	ExpressionLimit	All set-ups	FALSE	0	UInt16
1-59	Flystart Test Pulses Frequency	ExpressionLimit	All set-ups	FALSE	0	UInt16

Par. No. #	Parameter description	Default value	4-set-up	Change during operation	Conversion index	Type
1-6* Load Depen. Setting						
1-60	Low Speed Load Compensation	100 %	All set-ups	TRUE	0	Int16
1-61	High Speed Load Compensation	100 %	All set-ups	TRUE	0	Int16
1-62	Slip Compensation	0 %	All set-ups	TRUE	0	Int16
1-63	Slip Compensation Time Constant	ExpressionLimit	All set-ups	TRUE	-2	Uint16
1-64	Resonance Dampening	100 %	All set-ups	TRUE	0	Uint16
1-65	Resonance Dampening Time Constant	5 ms	All set-ups	TRUE	-3	Uint8
1-66	Min. Current at Low Speed	ExpressionLimit	All set-ups	TRUE	0	Uint8
1-7* Start Adjustments						
1-70	PM Start Mode	[1] Parking	All set-ups	TRUE	-	Uint8
1-71	Start Delay	00 s	All set-ups	TRUE	-1	Uint16
1-72	Start Function	ExpressionLimit	All set-ups	TRUE	-	Uint8
1-73	Flying Start	ExpressionLimit	All set-ups	FALSE	-	Uint8
1-74	Start Speed [RPM]	ExpressionLimit	All set-ups	TRUE	67	Uint16
1-75	Start Speed [Hz]	ExpressionLimit	All set-ups	TRUE	-1	Uint16
1-76	Start Current	0 A	All set-ups	TRUE	-2	Uint32
1-77	Compressor Start Max Speed [RPM]	ExpressionLimit	All set-ups	TRUE	67	Uint16
1-78	Compressor Start Max Speed [Hz]	ExpressionLimit	All set-ups	TRUE	-1	Uint16
1-79	Compressor Start Max Time to Trip	5 s	All set-ups	TRUE	-1	Uint8
1-8* Stop Adjustments						
1-80	Function at Stop	[0] Coast	All set-ups	TRUE	-	Uint8
1-81	Min Speed for Function at Stop [RPM]	ExpressionLimit	All set-ups	TRUE	67	Uint16
1-82	Min Speed for Function at Stop [Hz]	ExpressionLimit	All set-ups	TRUE	-1	Uint16
1-86	Compressor Min. Speed for Trip [RPM]	ExpressionLimit	All set-ups	TRUE	67	Uint16
1-87	Compressor Min. Speed for Trip [Hz]	ExpressionLimit	All set-ups	TRUE	-1	Uint16
1-9* Motor Temperature						
1-90	Motor Thermal Protection	ExpressionLimit	All set-ups	TRUE	-	Uint8
1-91	Motor External Fan	[0] None	All set-ups	TRUE	-	Uint8
1-93	Thermistor Source	[0] None	All set-ups	TRUE	-	Uint8

Table 4.4

4.1.4 2-** Brakes

Par. No. #	Parameter description	Default value	4-set-up	Change during operation	Conversion index	Type
2-0* DC-Brake						
2-00	DC Hold/Preheat Current	50 %	All set-ups	TRUE	0	Uint8
2-01	DC Brake Current	50 %	All set-ups	TRUE	0	Uint16
2-02	DC Braking Time	10 s	All set-ups	TRUE	-1	Uint16
2-03	DC Brake Cut In Speed [RPM]	ExpressionLimit	All set-ups	TRUE	67	Uint16
2-04	DC Brake Cut In Speed [Hz]	ExpressionLimit	All set-ups	TRUE	-1	Uint16
2-06	Parking Current	50 %	All set-ups	TRUE	0	Uint16
2-07	Parking Time	3 s	All set-ups	TRUE	-1	Uint16

2-1* Brake Energy Funct.						
2-10	Brake Function	ExpressionLimit	All set-ups	TRUE	-	Uint8
2-16	AC brake Max. Current	100 %	All set-ups	TRUE	-1	Uint32
2-17	Over-voltage Control	[2] Enabled	All set-ups	TRUE	-	Uint8

Table 4.5

4.1.5 3-** Reference/Ramps

Par. No. #	Parameter description	Default value	4-set-up	Change during operation	Conversion index	Type
3-0* Reference Limits						
3-02	Minimum Reference	ExpressionLimit	All set-ups	TRUE	-3	Int32
3-03	Maximum Reference	ExpressionLimit	All set-ups	TRUE	-3	Int32
3-04	Reference Function	[0] Sum	All set-ups	TRUE	-	Uint8
3-1* References						
3-10	Preset Reference	0 %	All set-ups	TRUE	-2	Int16
3-11	Jog Speed [Hz]	ExpressionLimit	All set-ups	TRUE	-1	Uint16
3-13	Reference Site	[0] Linked to Hand / Auto	All set-ups	TRUE	-	Uint8
3-14	Preset Relative Reference	0 %	All set-ups	TRUE	-2	Int32
3-15	Reference 1 Source	[1] Analog Input 53	All set-ups	TRUE	-	Uint8
3-16	Reference 2 Source	[20] Digital pot.meter	All set-ups	TRUE	-	Uint8
3-17	Reference 3 Source	[0] No function	All set-ups	TRUE	-	Uint8
3-19	Jog Speed [RPM]	ExpressionLimit	All set-ups	TRUE	67	Uint16
3-4* Ramp 1						
3-41	Ramp 1 Ramp Up Time	ExpressionLimit	All set-ups	TRUE	-2	Uint32
3-42	Ramp 1 Ramp Down Time	ExpressionLimit	All set-ups	TRUE	-2	Uint32
3-5* Ramp 2						
3-51	Ramp 2 Ramp Up Time	ExpressionLimit	All set-ups	TRUE	-2	Uint32
3-52	Ramp 2 Ramp Down Time	ExpressionLimit	All set-ups	TRUE	-2	Uint32
3-8* Other Ramps						
3-80	Jog Ramp Time	ExpressionLimit	All set-ups	TRUE	-2	Uint32
3-81	Quick Stop Ramp Time	ExpressionLimit	2 set-ups	TRUE	-2	Uint32
3-82	Starting Ramp Up Time	ExpressionLimit	2 set-ups	TRUE	-2	Uint32
3-9* Digital Pot.Meter						
3-90	Step Size	0.10 %	All set-ups	TRUE	-2	Uint16
3-91	Ramp Time	1 s	All set-ups	TRUE	-2	Uint32
3-92	Power Restore	[0] Off	All set-ups	TRUE	-	Uint8
3-93	Maximum Limit	100 %	All set-ups	TRUE	0	Int16
3-94	Minimum Limit	0 %	All set-ups	TRUE	0	Int16
3-95	Ramp Delay	1 N/A	All set-ups	TRUE	-3	TimD

Table 4.6

4.1.6 4-** Limits/Warnings

Par. No. #	Parameter description	Default value	4-set-up	Change during operation	Conversion index	Type
4-1* Motor Limits						
4-10	Motor Speed Direction	[0] Clockwise	All set-ups	FALSE	-	Uint8
4-11	Motor Speed Low Limit [RPM]	ExpressionLimit	All set-ups	TRUE	67	Uint16
4-12	Motor Speed Low Limit [Hz]	ExpressionLimit	All set-ups	TRUE	-1	Uint16
4-13	Motor Speed High Limit [RPM]	ExpressionLimit	All set-ups	TRUE	67	Uint16
4-14	Motor Speed High Limit [Hz]	ExpressionLimit	All set-ups	TRUE	-1	Uint16
4-16	Torque Limit Motor Mode	110 %	All set-ups	TRUE	-1	Uint16
4-17	Torque Limit Generator Mode	100 %	All set-ups	TRUE	-1	Uint16
4-18	Current Limit	ExpressionLimit	All set-ups	TRUE	-1	Uint32
4-19	Max Output Frequency	ExpressionLimit	All set-ups	FALSE	-1	Uint16
4-5* Adj. Warnings						
4-50	Warning Current Low	0 A	All set-ups	TRUE	-2	Uint32
4-51	Warning Current High	ImaxVLT (P1637)	All set-ups	TRUE	-2	Uint32
4-52	Warning Speed Low	0 RPM	All set-ups	TRUE	67	Uint16
4-53	Warning Speed High	outputSpeedHighLimit (P413)	All set-ups	TRUE	67	Uint16
4-54	Warning Reference Low	-999999 N/A	All set-ups	TRUE	-3	Int32
4-55	Warning Reference High	999999 N/A	All set-ups	TRUE	-3	Int32
4-56	Warning Feedback Low	-999999 ReferenceFeedbackUnit	All set-ups	TRUE	-3	Int32
4-57	Warning Feedback High	999999 ReferenceFeedbackUnit	All set-ups	TRUE	-3	Int32
4-58	Missing Motor Phase Function	ExpressionLimit	All set-ups	TRUE	-	Uint8
4-6* Speed Bypass						
4-60	Bypass Speed From [RPM]	ExpressionLimit	All set-ups	TRUE	67	Uint16
4-61	Bypass Speed From [Hz]	ExpressionLimit	All set-ups	TRUE	-1	Uint16
4-62	Bypass Speed To [RPM]	ExpressionLimit	All set-ups	TRUE	67	Uint16
4-63	Bypass Speed To [Hz]	ExpressionLimit	All set-ups	TRUE	-1	Uint16
4-64	Semi-Auto Bypass Set-up	[0] Off	All set-ups	FALSE	-	Uint8

Table 4.7

4.1.7 5-** Digital In/Out

Par. No. #	Parameter description	Default value	4-set-up	Change during operation	Conversion index	Type
5-0* Digital I/O mode						
5-00	Digital I/O Mode	[0] PNP - Active at 24V	All set-ups	FALSE	-	Uint8
5-01	Terminal 27 Mode	[0] Input	All set-ups	TRUE	-	Uint8
5-02	Terminal 29 Mode	[0] Input	All set-ups	TRUE	-	Uint8
5-1* Digital Inputs						
5-10	Terminal 18 Digital Input	ExpressionLimit	All set-ups	TRUE	-	Uint8
5-11	Terminal 19 Digital Input	ExpressionLimit	All set-ups	TRUE	-	Uint8
5-12	Terminal 27 Digital Input	ExpressionLimit	All set-ups	TRUE	-	Uint8
5-13	Terminal 29 Digital Input	ExpressionLimit	All set-ups	TRUE	-	Uint8
5-14	Terminal 32 Digital Input	ExpressionLimit	All set-ups	TRUE	-	Uint8
5-15	Terminal 33 Digital Input	ExpressionLimit	All set-ups	TRUE	-	Uint8
5-16	Terminal X30/2 Digital Input	ExpressionLimit	All set-ups	TRUE	-	Uint8

Par. No. #	Parameter description	Default value	4-set-up	Change during operation	Conversion index	Type
5-17	Terminal X30/3 Digital Input	ExpressionLimit	All set-ups	TRUE	-	Uint8
5-18	Terminal X30/4 Digital Input	ExpressionLimit	All set-ups	TRUE	-	Uint8
5-19	Terminal 37 Safe Stop	[1] Safe Stop Alarm	All set-ups	TRUE	-	Uint8
5-3* Digital Outputs						
5-30	Terminal 27 Digital Output	[0] No operation	All set-ups	TRUE	-	Uint8
5-31	Terminal 29 Digital Output	[0] No operation	All set-ups	TRUE	-	Uint8
5-32	Term X30/6 Digi Out (MCB 101)	[0] No operation	All set-ups	TRUE	-	Uint8
5-33	Term X30/7 Digi Out (MCB 101)	[0] No operation	All set-ups	TRUE	-	Uint8
5-4* Relays						
5-40	Function Relay	ExpressionLimit	All set-ups	TRUE	-	Uint8
5-41	On Delay, Relay	0.01 s	All set-ups	TRUE	-2	Uint16
5-42	Off Delay, Relay	0.01 s	All set-ups	TRUE	-2	Uint16
5-5* Pulse Input						
5-50	Term. 29 Low Frequency	100 Hz	All set-ups	TRUE	0	Uint32
5-51	Term. 29 High Frequency	100 Hz	All set-ups	TRUE	0	Uint32
5-52	Term. 29 Low Ref./Feedb. Value	0 N/A	All set-ups	TRUE	-3	Int32
5-53	Term. 29 High Ref./Feedb. Value	100 N/A	All set-ups	TRUE	-3	Int32
5-54	Pulse Filter Time Constant #29	100 ms	All set-ups	FALSE	-3	Uint16
5-55	Term. 33 Low Frequency	100 Hz	All set-ups	TRUE	0	Uint32
5-56	Term. 33 High Frequency	100 Hz	All set-ups	TRUE	0	Uint32
5-57	Term. 33 Low Ref./Feedb. Value	0 N/A	All set-ups	TRUE	-3	Int32
5-58	Term. 33 High Ref./Feedb. Value	100 N/A	All set-ups	TRUE	-3	Int32
5-59	Pulse Filter Time Constant #33	100 ms	All set-ups	FALSE	-3	Uint16
5-6* Pulse Output						
5-60	Terminal 27 Pulse Output Variable	[0] No operation	All set-ups	TRUE	-	Uint8
5-62	Pulse Output Max Freq #27	5000 Hz	All set-ups	TRUE	0	Uint32
5-63	Terminal 29 Pulse Output Variable	[0] No operation	All set-ups	TRUE	-	Uint8
5-65	Pulse Output Max Freq #29	5000 Hz	All set-ups	TRUE	0	Uint32
5-66	Terminal X30/6 Pulse Output Variable	[0] No operation	All set-ups	TRUE	-	Uint8
5-68	Pulse Output Max Freq #X30/6	5000 Hz	All set-ups	TRUE	0	Uint32
5-9* Bus Controlled						
5-90	Digital & Relay Bus Control	0 N/A	All set-ups	TRUE	0	Uint32
5-93	Pulse Out #27 Bus Control	0 %	All set-ups	TRUE	-2	N2
5-94	Pulse Out #27 Timeout Preset	0 %	1 set-up	TRUE	-2	Uint16
5-95	Pulse Out #29 Bus Control	0 %	All set-ups	TRUE	-2	N2
5-96	Pulse Out #29 Timeout Preset	0 %	1 set-up	TRUE	-2	Uint16
5-97	Pulse Out #X30/6 Bus Control	0 %	All set-ups	TRUE	-2	N2
5-98	Pulse Out #X30/6 Timeout Preset	0 %	1 set-up	TRUE	-2	Uint16

Table 4.8

4.1.8 6-** Analog In/Out

Par. No. #	Parameter description	Default value	4-set-up	Change during operation	Conversion index	Type
6-0* Analog I/O Mode						
6-00	Live Zero Timeout Time	10 s	All set-ups	TRUE	0	Uint8
6-01	Live Zero Timeout Function	[0] Off	All set-ups	TRUE	-	Uint8

Par. No. #	Parameter description	Default value	4-set-up	Change during operation	Conversion index	Type
6-02	Fire Mode Live Zero Timeout Function	[0] Off	All set-ups	TRUE	-	Uint8
6-1* Analog Input 53						
6-10	Terminal 53 Low Voltage	0.07 V	All set-ups	TRUE	-2	Int16
6-11	Terminal 53 High Voltage	10 V	All set-ups	TRUE	-2	Int16
6-12	Terminal 53 Low Current	4 mA	All set-ups	TRUE	-5	Int16
6-13	Terminal 53 High Current	20 mA	All set-ups	TRUE	-5	Int16
6-14	Terminal 53 Low Ref./Feedb. Value	0 N/A	All set-ups	TRUE	-3	Int32
6-15	Terminal 53 High Ref./Feedb. Value	ExpressionLimit	All set-ups	TRUE	-3	Int32
6-16	Terminal 53 Filter Time Constant	0.001 s	All set-ups	TRUE	-3	Uint16
6-17	Terminal 53 Live Zero	[1] Enabled	All set-ups	TRUE	-	Uint8
6-2* Analog Input 54						
6-20	Terminal 54 Low Voltage	0.07 V	All set-ups	TRUE	-2	Int16
6-21	Terminal 54 High Voltage	10 V	All set-ups	TRUE	-2	Int16
6-22	Terminal 54 Low Current	4 mA	All set-ups	TRUE	-5	Int16
6-23	Terminal 54 High Current	20 mA	All set-ups	TRUE	-5	Int16
6-24	Terminal 54 Low Ref./Feedb. Value	-1 N/A	All set-ups	TRUE	-3	Int32
6-25	Terminal 54 High Ref./Feedb. Value	ExpressionLimit	All set-ups	TRUE	-3	Int32
6-26	Terminal 54 Filter Time Constant	0.001 s	All set-ups	TRUE	-3	Uint16
6-27	Terminal 54 Live Zero	[1] Enabled	All set-ups	TRUE	-	Uint8
6-3* Analog Input X30/11						
6-30	Terminal X30/11 Low Voltage	0.07 V	All set-ups	TRUE	-2	Int16
6-31	Terminal X30/11 High Voltage	10 V	All set-ups	TRUE	-2	Int16
6-34	Term. X30/11 Low Ref./Feedb. Value	0 N/A	All set-ups	TRUE	-3	Int32
6-35	Term. X30/11 High Ref./Feedb. Value	100 N/A	All set-ups	TRUE	-3	Int32
6-36	Term. X30/11 Filter Time Constant	0.001 s	All set-ups	TRUE	-3	Uint16
6-37	Term. X30/11 Live Zero	[1] Enabled	All set-ups	TRUE	-	Uint8
6-4* Analog Input X30/12						
6-40	Terminal X30/12 Low Voltage	0.07 V	All set-ups	TRUE	-2	Int16
6-41	Terminal X30/12 High Voltage	10 V	All set-ups	TRUE	-2	Int16
6-44	Term. X30/12 Low Ref./Feedb. Value	0 N/A	All set-ups	TRUE	-3	Int32
6-45	Term. X30/12 High Ref./Feedb. Value	100 N/A	All set-ups	TRUE	-3	Int32
6-46	Term. X30/12 Filter Time Constant	0.001 s	All set-ups	TRUE	-3	Uint16
6-47	Term. X30/12 Live Zero	[1] Enabled	All set-ups	TRUE	-	Uint8
6-5* Analog Output 42						
6-50	Terminal 42 Output	[100] Output frequency	All set-ups	TRUE	-	Uint8
6-51	Terminal 42 Output Min Scale	0 %	All set-ups	TRUE	-2	Int16
6-52	Terminal 42 Output Max Scale	100 %	All set-ups	TRUE	-2	Int16
6-53	Terminal 42 Output Bus Control	0 %	All set-ups	TRUE	-2	N2
6-54	Terminal 42 Output Timeout Preset	0 %	1 set-up	TRUE	-2	Uint16
6-6* Analog Output X30/8						
6-60	Terminal X30/8 Output	[0] No operation	All set-ups	TRUE	-	Uint8
6-61	Terminal X30/8 Min. Scale	0 %	All set-ups	TRUE	-2	Int16
6-62	Terminal X30/8 Max. Scale	100 %	All set-ups	TRUE	-2	Int16

Par. No. #	Parameter description	Default value	4-set-up	Change during operation	Conversion index	Type
6-63	Terminal X30/8 Output Bus Control	0 %	All set-ups	TRUE	-2	N2
6-64	Terminal X30/8 Output Timeout Preset	0 %	1 set-up	TRUE	-2	Uint16

Table 4.9

4.1.9 8-** Communication and Options

Par. No. #	Parameter description	Default value	4-set-up	Change during operation	Conversion index	Type
8-0* General Settings						
8-01	Control Site	ExpressionLimit	All set-ups	TRUE	-	Uint8
8-02	Control Source	ExpressionLimit	All set-ups	TRUE	-	Uint8
8-03	Control Timeout Time	ExpressionLimit	1 set-up	TRUE	-1	Uint32
8-04	Control Timeout Function	[0] Off	1 set-up	TRUE	-	Uint8
8-05	End-of-Timeout Function	[1] Resume set-up	1 set-up	TRUE	-	Uint8
8-06	Reset Control Timeout	[0] Do not reset	All set-ups	TRUE	-	Uint8
8-07	Diagnosis Trigger	[0] Disable	2 set-ups	TRUE	-	Uint8
8-1* Control Settings						
8-10	Control Profile	[0] FC profile	All set-ups	TRUE	-	Uint8
8-13	Configurable Status Word STW	[1] Profile Default	All set-ups	TRUE	-	Uint8
8-3* FC Port Settings						
8-30	Protocol	[0] FC	1 set-up	TRUE	-	Uint8
8-31	Address	ExpressionLimit	1 set-up	TRUE	0	Uint8
8-32	Baud Rate	ExpressionLimit	1 set-up	TRUE	-	Uint8
8-33	Parity / Stop Bits	ExpressionLimit	1 set-up	TRUE	-	Uint8
8-35	Minimum Response Delay	ExpressionLimit	1 set-up	TRUE	-3	Uint16
8-36	Maximum Response Delay	ExpressionLimit	1 set-up	TRUE	-3	Uint16
8-37	Maximum Inter-Char Delay	ExpressionLimit	1 set-up	TRUE	-5	Uint16
8-4* Adv. Protocol Set.						
8-40	Telegram Selection	[1] Standard telegram 1	2 set-ups	TRUE	-	Uint8
8-45	BTM Transaction Command	[0] Off	All set-ups	FALSE	-	Uint8
8-46	BTM Transaction Status	[0] Off	All set-ups	TRUE	-	Uint8
8-47	BTM Timeout	60 s	1 set-up	FALSE	0	Uint16
8-5* Digital/Bus						
8-50	Coasting Select	[3] Logic OR	All set-ups	TRUE	-	Uint8
8-52	DC Brake Select	ExpressionLimit	All set-ups	TRUE	-	Uint8
8-53	Start Select	[3] Logic OR	All set-ups	TRUE	-	Uint8
8-54	Reversing Select	ExpressionLimit	All set-ups	TRUE	-	Uint8
8-55	Set-up Select	[3] Logic OR	All set-ups	TRUE	-	Uint8
8-56	Preset Reference Select	[3] Logic OR	All set-ups	TRUE	-	Uint8
8-8* FC Port Diagnostics						
8-80	Bus Message Count	0 N/A	All set-ups	TRUE	0	Uint32
8-81	Bus Error Count	0 N/A	All set-ups	TRUE	0	Uint32
8-82	Slave Message Count	0 N/A	All set-ups	TRUE	0	Uint32
8-83	Slave Error Count	0 N/A	All set-ups	TRUE	0	Uint32
8-9* Bus Jog / Feedback						
8-90	Bus Jog 1 Speed	100 RPM	All set-ups	TRUE	67	Uint16
8-91	Bus Jog 2 Speed	ExpressionLimit	All set-ups	TRUE	67	Uint16

Par. No. #	Parameter description	Default value	4-set-up	Change during operation	Conversion index	Type
8-94	Bus Feedback 1	0 N/A	1 set-up	TRUE	0	N2
8-95	Bus Feedback 2	0 N/A	1 set-up	TRUE	0	N2
8-96	Bus Feedback 3	0 N/A	1 set-up	TRUE	0	N2

Table 4.10

4

4.1.10 11-** FC 103 LON

Par. No. #	Parameter description	Default value	4-set-up	Change during operation	Conversion index	Type
11-2* LON Param. Access						
11-21	Store Data Values	[0] Off	All set-ups	TRUE	-	Uint8
11-9* AK LonWorks						
11-90	VLT Network Address	0 N/A	1 set-up	TRUE	0	Uint16
11-91	AK Service Pin	[0] Off	1 set-up	TRUE	-	Uint8
11-98	Alarm Text	0 N/A	All set-ups	FALSE	0	VisStr[32]
11-99	Alarm Status	0 N/A	All set-ups	FALSE	0	Uint8

Table 4.11

4.1.11 13-** Smart Logic Controller

Par. No. #	Parameter description	Default value	4-set-up	Change during operation	Conversion index	Type
13-0* SLC Settings						
13-00	SL Controller Mode	ExpressionLimit	2 set-ups	TRUE	-	Uint8
13-01	Start Event	ExpressionLimit	2 set-ups	TRUE	-	Uint8
13-02	Stop Event	ExpressionLimit	2 set-ups	TRUE	-	Uint8
13-03	Reset SLC	[0] Do not reset SLC	All set-ups	TRUE	-	Uint8
13-1* Comparators						
13-10	Comparator Operand	ExpressionLimit	2 set-ups	TRUE	-	Uint8
13-11	Comparator Operator	ExpressionLimit	2 set-ups	TRUE	-	Uint8
13-12	Comparator Value	ExpressionLimit	2 set-ups	TRUE	-3	Int32
13-2* Timers						
13-20	SL Controller Timer	ExpressionLimit	1 set-up	TRUE	-3	TimD
13-4* Logic Rules						
13-40	Logic Rule Boolean 1	ExpressionLimit	2 set-ups	TRUE	-	Uint8
13-41	Logic Rule Operator 1	ExpressionLimit	2 set-ups	TRUE	-	Uint8
13-42	Logic Rule Boolean 2	ExpressionLimit	2 set-ups	TRUE	-	Uint8
13-43	Logic Rule Operator 2	ExpressionLimit	2 set-ups	TRUE	-	Uint8
13-44	Logic Rule Boolean 3	ExpressionLimit	2 set-ups	TRUE	-	Uint8
13-5* States						
13-51	SL Controller Event	ExpressionLimit	2 set-ups	TRUE	-	Uint8
13-52	SL Controller Action	ExpressionLimit	2 set-ups	TRUE	-	Uint8

Table 4.12

4.1.12 14-** Special Functions

Par. No. #	Parameter description	Default value	4-set-up	Change during operation	Conversion index	Type
14-0* Inverter Switching						
14-00	Switching Pattern	[0] 60 AVM	All set-ups	TRUE	-	Uint8
14-01	Switching Frequency	ExpressionLimit	All set-ups	TRUE	-	Uint8
14-03	Overmodulation	[1] On	All set-ups	FALSE	-	Uint8
14-04	PWM Random	[0] Off	All set-ups	TRUE	-	Uint8
14-1* Mains On/Off						
14-12	Function at Mains Imbalance	[0] Trip	All set-ups	TRUE	-	Uint8
14-2* Reset Functions						
14-20	Reset Mode	[3] Automatic reset x 3	All set-ups	TRUE	-	Uint8
14-21	Automatic Restart Time	300 s	All set-ups	TRUE	0	Uint16
14-22	Operation Mode	[0] Normal operation	All set-ups	TRUE	-	Uint8
14-23	Typecode Setting	ExpressionLimit	2 set-ups	FALSE	-	Uint8
14-25	Trip Delay at Torque Limit	60 s	All set-ups	TRUE	0	Uint8
14-26	Trip Delay at Inverter Fault	ExpressionLimit	All set-ups	TRUE	0	Uint8
14-28	Production Settings	[0] No action	All set-ups	TRUE	-	Uint8
14-29	Service Code	0 N/A	All set-ups	TRUE	0	Int32
14-3* Current Limit Ctrl.						
14-30	Current Lim Ctrl, Proportional Gain	100 %	All set-ups	FALSE	0	Uint16
14-31	Current Lim Ctrl, Integration Time	ExpressionLimit	All set-ups	FALSE	-3	Uint16
14-32	Current Lim Ctrl, Filter Time	ExpressionLimit	All set-ups	TRUE	-4	Uint16
14-4* Energy Optimising						
14-40	VT Level	66 %	All set-ups	FALSE	0	Uint8
14-41	AEO Minimum Magnetisation	ExpressionLimit	All set-ups	TRUE	0	Uint8
14-42	Minimum AEO Frequency	10 Hz	All set-ups	TRUE	0	Uint8
14-43	Motor Cosphi	ExpressionLimit	All set-ups	TRUE	-2	Uint16
14-5* Environment						
14-50	RFI Filter	[1] On	1 set-up	FALSE	-	Uint8
14-52	Fan Control	[0] Auto	All set-ups	TRUE	-	Uint8
14-53	Fan Monitor	[1] Warning	All set-ups	TRUE	-	Uint8
14-55	Output Filter	[0] No Filter	1 set-up	FALSE	-	Uint8
14-6* Auto Derate						
14-60	Function at Over Temperature	[0] Trip	All set-ups	TRUE	-	Uint8
14-61	Function at Inverter Overload	[0] Trip	All set-ups	TRUE	-	Uint8
14-62	Inv. Overload Derate Current	95 %	All set-ups	TRUE	0	Uint16

Table 4.13

4.1.13 15-** FC Information

Par. No. #	Parameter description	Default value	4-set-up	Change during operation	Conversion index	Type
15-0* Operating Data						
15-00	Operating hours	0 h	All set-ups	FALSE	74	Uint32
15-01	Running Hours	0 h	All set-ups	FALSE	74	Uint32
15-02	kWh Counter	0 kWh	All set-ups	FALSE	75	Uint32
15-03	Power Up's	0 N/A	All set-ups	FALSE	0	Uint32
15-04	Over Temp's	0 N/A	All set-ups	FALSE	0	Uint16

Par. No. #	Parameter description	Default value	4-set-up	Change during operation	Conversion index	Type
15-05	Over Volt's	0 N/A	All set-ups	FALSE	0	Uint16
15-06	Reset kWh Counter	[0] Do not reset	All set-ups	TRUE	-	Uint8
15-07	Reset Running Hours Counter	[0] Do not reset	All set-ups	TRUE	-	Uint8
15-08	Number of Starts	0 N/A	All set-ups	FALSE	0	Uint32
15-1* Data Log Settings						
15-10	Logging Source	0	2 set-ups	TRUE	-	Uint16
15-11	Logging Interval	ExpressionLimit	2 set-ups	TRUE	-3	TimD
15-12	Trigger Event	[0] False	1 set-up	TRUE	-	Uint8
15-13	Logging Mode	[0] Log always	2 set-ups	TRUE	-	Uint8
15-14	Samples Before Trigger	50 N/A	2 set-ups	TRUE	0	Uint8
15-2* Historic Log						
15-20	Historic Log: Event	0 N/A	All set-ups	FALSE	0	Uint8
15-21	Historic Log: Value	0 N/A	All set-ups	FALSE	0	Uint32
15-22	Historic Log: Time	0 ms	All set-ups	FALSE	-3	Uint32
15-23	Historic log: Date and Time	ExpressionLimit	All set-ups	FALSE	0	TimeOfDay
15-3* Alarm Log						
15-30	Alarm Log: Error Code	0 N/A	All set-ups	FALSE	0	Uint8
15-31	Alarm Log: Value	0 N/A	All set-ups	FALSE	0	Int16
15-32	Alarm Log: Time	0 s	All set-ups	FALSE	0	Uint32
15-33	Alarm Log: Date and Time	ExpressionLimit	All set-ups	FALSE	0	TimeOfDay
15-34	Alarm Log: Status	0 N/A	All set-ups	FALSE	0	Uint8
15-35	Alarm Log: Alarm Text	0 N/A	All set-ups	FALSE	0	VisStr[32]
15-4* Drive Identification						
15-40	FC Type	0 N/A	All set-ups	FALSE	0	VisStr[6]
15-41	Power Section	0 N/A	All set-ups	FALSE	0	VisStr[20]
15-42	Voltage	0 N/A	All set-ups	FALSE	0	VisStr[20]
15-43	Software Version	0 N/A	All set-ups	FALSE	0	VisStr[5]
15-44	Ordered Typecode String	0 N/A	All set-ups	FALSE	0	VisStr[40]
15-45	Actual Typecode String	0 N/A	All set-ups	FALSE	0	VisStr[40]
15-46	Frequency Converter Ordering No	0 N/A	All set-ups	FALSE	0	VisStr[8]
15-47	Power Card Ordering No	0 N/A	All set-ups	FALSE	0	VisStr[8]
15-48	LCP Id No	0 N/A	All set-ups	FALSE	0	VisStr[20]
15-49	SW ID Control Card	0 N/A	All set-ups	FALSE	0	VisStr[20]
15-50	SW ID Power Card	0 N/A	All set-ups	FALSE	0	VisStr[20]
15-51	Frequency Converter Serial Number	0 N/A	All set-ups	FALSE	0	VisStr[10]
15-53	Power Card Serial Number	0 N/A	All set-ups	FALSE	0	VisStr[19]
15-6* Option Ident						
15-60	Option Mounted	0 N/A	All set-ups	FALSE	0	VisStr[30]
15-61	Option SW Version	0 N/A	All set-ups	FALSE	0	VisStr[20]
15-62	Option Ordering No	0 N/A	All set-ups	FALSE	0	VisStr[8]
15-63	Option Serial No	0 N/A	All set-ups	FALSE	0	VisStr[18]
15-70	Option in Slot A	0 N/A	All set-ups	FALSE	0	VisStr[30]
15-71	Slot A Option SW Version	0 N/A	All set-ups	FALSE	0	VisStr[20]
15-72	Option in Slot B	0 N/A	All set-ups	FALSE	0	VisStr[30]
15-73	Slot B Option SW Version	0 N/A	All set-ups	FALSE	0	VisStr[20]
15-74	Option in Slot C0/E0	0 N/A	All set-ups	FALSE	0	VisStr[30]
15-75	Slot C0/E0 Option SW Version	0 N/A	All set-ups	FALSE	0	VisStr[20]
15-76	Option in Slot C1/E1	0 N/A	All set-ups	FALSE	0	VisStr[30]
15-77	Slot C1/E1 Option SW Version	0 N/A	All set-ups	FALSE	0	VisStr[20]
15-9* Parameter Info						

Par. No. #	Parameter description	Default value	4-set-up	Change during operation	Conversion index	Type
15-92	Defined Parameters	0 N/A	All set-ups	FALSE	0	Uint16
15-93	Modified Parameters	0 N/A	All set-ups	FALSE	0	Uint16
15-99	Parameter Metadata	0 N/A	All set-ups	FALSE	0	Uint16

Table 4.14

4.1.14 16-** Data Readouts

Par. No. #	Parameter description	Default value	4-set-up	Change during operation	Conversion index	Type
16-0* General Status						
16-00	Control Word	0 N/A	All set-ups	FALSE	0	V2
16-01	Reference [Unit]	0 ReferenceFeed-backUnit	All set-ups	FALSE	-3	Int32
16-02	Reference [%]	0 %	All set-ups	FALSE	-1	Int16
16-03	Status Word	0 N/A	All set-ups	FALSE	0	V2
16-05	Main Actual Value [%]	0 %	All set-ups	FALSE	-2	N2
16-09	Custom Readout	0 CustomReadoutUnit	All set-ups	FALSE	-2	Int32
16-1* Motor Status						
16-10	Power [kW]	0 kW	All set-ups	FALSE	1	Int32
16-11	Power [hp]	0 hp	All set-ups	FALSE	-2	Int32
16-12	Motor Voltage	0 V	All set-ups	FALSE	-1	Uint16
16-13	Frequency	0 Hz	All set-ups	FALSE	-1	Uint16
16-14	Motor current	0 A	All set-ups	FALSE	-2	Int32
16-15	Frequency [%]	0 %	All set-ups	FALSE	-2	N2
16-16	Torque [Nm]	0 Nm	All set-ups	FALSE	-1	Int32
16-17	Speed [RPM]	0 RPM	All set-ups	FALSE	67	Int32
16-18	Motor Thermal	0 %	All set-ups	FALSE	0	Uint8
16-22	Torque [%]	0 %	All set-ups	FALSE	0	Int16
16-3* Drive Status						
16-30	DC Link Voltage	0 V	All set-ups	FALSE	0	Uint16
16-32	Brake Energy /s	0 kW	All set-ups	FALSE	0	Uint32
16-33	Brake Energy /2 min	0 kW	All set-ups	FALSE	0	Uint32
16-34	Heatsink Temp.	0 °C	All set-ups	FALSE	100	Uint8
16-35	Inverter Thermal	0 %	All set-ups	FALSE	0	Uint8
16-36	Inv. Nom. Current	ExpressionLimit	All set-ups	FALSE	-2	Uint32
16-37	Inv. Max. Current	ExpressionLimit	All set-ups	FALSE	-2	Uint32
16-38	SL Controller State	0 N/A	All set-ups	FALSE	0	Uint8
16-39	Control Card Temp.	0 °C	All set-ups	FALSE	100	Uint8
16-40	Logging Buffer Full	[0] No	All set-ups	TRUE	-	Uint8
16-41	LCP Bottom Statusline	0 N/A	All set-ups	TRUE	0	VisStr[50]
16-5* Ref. & Feedb.						
16-50	External Reference	0 N/A	All set-ups	FALSE	-1	Int16
16-52	Feedback[Unit]	0 ProcessCtrlUnit	All set-ups	FALSE	-3	Int32
16-53	Digi Pot Reference	0 N/A	All set-ups	FALSE	-2	Int16
16-54	Feedback 1 [Unit]	0 ProcessCtrlUnit	All set-ups	FALSE	-3	Int32
16-55	Feedback 2 [Unit]	0 ProcessCtrlUnit	All set-ups	FALSE	-3	Int32
16-56	Feedback 3 [Unit]	0 ProcessCtrlUnit	All set-ups	FALSE	-3	Int32
16-6* Inputs & Outputs						
16-60	Digital Input	0 N/A	All set-ups	FALSE	0	Uint16

Par. No. #	Parameter description	Default value	4-set-up	Change during operation	Conversion index	Type
16-61	Terminal 53 Switch Setting	[0] Current	All set-ups	FALSE	-	Uint8
16-62	Analog Input 53	0 N/A	All set-ups	FALSE	-3	Int32
16-63	Terminal 54 Switch Setting	[0] Current	All set-ups	FALSE	-	Uint8
16-64	Analog Input 54	0 N/A	All set-ups	FALSE	-3	Int32
16-65	Analog Output 42 [mA]	0 N/A	All set-ups	FALSE	-3	Int16
16-66	Digital Output [bin]	0 N/A	All set-ups	FALSE	0	Int16
16-67	Pulse Input #29 [Hz]	0 N/A	All set-ups	FALSE	0	Int32
16-68	Pulse Input #33 [Hz]	0 N/A	All set-ups	FALSE	0	Int32
16-69	Pulse Output #27 [Hz]	0 N/A	All set-ups	FALSE	0	Int32
16-70	Pulse Output #29 [Hz]	0 N/A	All set-ups	FALSE	0	Int32
16-71	Relay Output [bin]	0 N/A	All set-ups	FALSE	0	Int16
16-72	Counter A	0 N/A	All set-ups	TRUE	0	Int32
16-73	Counter B	0 N/A	All set-ups	TRUE	0	Int32
16-75	Analog In X30/11	0 N/A	All set-ups	FALSE	-3	Int32
16-76	Analog In X30/12	0 N/A	All set-ups	FALSE	-3	Int32
16-77	Analog Out X30/8 [mA]	0 N/A	All set-ups	FALSE	-3	Int16
16-8* Fieldbus & FC Port						
16-80	Fieldbus CTW 1	0 N/A	All set-ups	FALSE	0	V2
16-82	Fieldbus REF 1	0 N/A	All set-ups	FALSE	0	N2
16-84	Comm. Option STW	0 N/A	All set-ups	FALSE	0	V2
16-85	FC Port CTW 1	0 N/A	All set-ups	FALSE	0	V2
16-86	FC Port REF 1	0 N/A	All set-ups	FALSE	0	N2
16-9* Diagnosis Readouts						
16-90	Alarm Word	0 N/A	All set-ups	FALSE	0	Uint32
16-91	Alarm Word 2	0 N/A	All set-ups	FALSE	0	Uint32
16-92	Warning Word	0 N/A	All set-ups	FALSE	0	Uint32
16-93	Warning Word 2	0 N/A	All set-ups	FALSE	0	Uint32
16-94	Ext. Status Word	0 N/A	All set-ups	FALSE	0	Uint32
16-95	Ext. Status Word 2	0 N/A	All set-ups	FALSE	0	Uint32
16-96	Maintenance Word	0 N/A	All set-ups	FALSE	0	Uint32

Table 4.15

4.1.15 18-** Info & Readouts

Par. No. #	Parameter description	Default value	4-set-up	Change during operation	Conversion index	Type
18-0* Maintenance Log						
18-00	Maintenance Log: Item	0 N/A	All set-ups	FALSE	0	Uint8
18-01	Maintenance Log: Action	0 N/A	All set-ups	FALSE	0	Uint8
18-02	Maintenance Log: Time	0 s	All set-ups	FALSE	0	Uint32
18-03	Maintenance Log: Date and Time	ExpressionLimit	All set-ups	FALSE	0	TimeOfDay
18-1* Fire Mode Log						
18-10	FireMode Log:Event	0 N/A	All set-ups	FALSE	0	Uint8
18-11	Fire Mode Log: Time	0 s	All set-ups	FALSE	0	Uint32
18-12	Fire Mode Log: Date and Time	ExpressionLimit	All set-ups	FALSE	0	TimeOfDay
18-3* Inputs & Outputs						
18-30	Analog Input X42/1	0 N/A	All set-ups	FALSE	-3	Int32
18-31	Analog Input X42/3	0 N/A	All set-ups	FALSE	-3	Int32
18-32	Analog Input X42/5	0 N/A	All set-ups	FALSE	-3	Int32

Par. No. #	Parameter description	Default value	4-set-up	Change during operation	Conversion index	Type
18-33	Analog Out X42/7 [V]	0 N/A	All set-ups	FALSE	-3	Int16
18-34	Analog Out X42/9 [V]	0 N/A	All set-ups	FALSE	-3	Int16
18-35	Analog Out X42/11 [V]	0 N/A	All set-ups	FALSE	-3	Int16

Table 4.16

4.1.16 20-** FC Closed Loop

Par. No. #	Parameter description	Default value	4-set-up	Change during operation	Conversion index	Type
20-0* Feedback						
20-00	Feedback 1 Source	[2] Analog Input 54	All set-ups	TRUE	-	UInt8
20-01	Feedback 1 Conversion	[2] Pressure to temperature	All set-ups	FALSE	-	UInt8
20-02	Feedback 1 Source Unit	ExpressionLimit	All set-ups	TRUE	-	UInt8
20-03	Feedback 2 Source	[0] No function	All set-ups	TRUE	-	UInt8
20-04	Feedback 2 Conversion	[0] Linear	All set-ups	FALSE	-	UInt8
20-05	Feedback 2 Source Unit	ExpressionLimit	All set-ups	TRUE	-	UInt8
20-06	Feedback 3 Source	[0] No function	All set-ups	TRUE	-	UInt8
20-07	Feedback 3 Conversion	[0] Linear	All set-ups	FALSE	-	UInt8
20-08	Feedback 3 Source Unit	ExpressionLimit	All set-ups	TRUE	-	UInt8
20-12	Reference/Feedback Unit	ExpressionLimit	All set-ups	TRUE	-	UInt8
20-2* Feedback/Setpoint						
20-20	Feedback Function	[3] Minimum	All set-ups	TRUE	-	UInt8
20-21	Setpoint 1	0 ProcessCtrlUnit	All set-ups	TRUE	-3	Int32
20-22	Setpoint 2	0 ProcessCtrlUnit	All set-ups	TRUE	-3	Int32
20-23	Setpoint 3	0 ProcessCtrlUnit	All set-ups	TRUE	-3	Int32
20-25	Setpoint Type	ExpressionLimit	All set-ups	TRUE	-	UInt8
20-3* Feedback Adv. Conv						
20-30	Refrigerant	[19] R404A	All set-ups	TRUE	-	UInt8
20-31	User Defined Refrigerant A1	10 N/A	All set-ups	TRUE	-4	UInt32
20-32	User Defined Refrigerant A2	-2250 N/A	All set-ups	TRUE	-2	Int32
20-33	User Defined Refrigerant A3	250 N/A	All set-ups	TRUE	-3	UInt32
20-4* Thermostat/Pressostat						
20-40	Thermostat/Pressostat Function	ExpressionLimit	All set-ups	TRUE	-	UInt8
20-41	Cut-out Value	ExpressionLimit	All set-ups	TRUE	-3	Int32
20-42	Cut-in Value	ExpressionLimit	All set-ups	TRUE	-3	Int32
20-7* PID Autotuning						
20-70	Closed Loop Type	[0] Auto	2 set-ups	TRUE	-	UInt8
20-71	PID Performance	[0] Normal	2 set-ups	TRUE	-	UInt8
20-72	PID Output Change	0.10 N/A	2 set-ups	TRUE	-2	UInt16
20-73	Minimum Feedback Level	-999999 ProcessCtrlUnit	2 set-ups	TRUE	-3	Int32
20-74	Maximum Feedback Level	999999 ProcessCtrlUnit	2 set-ups	TRUE	-3	Int32
20-79	PID Autotuning	[0] Disabled	All set-ups	TRUE	-	UInt8
20-8* PID Basic Settings						
20-81	PID Normal/ Inverse Control	[1] Inverse	All set-ups	TRUE	-	UInt8
20-82	PID Start Speed [RPM]	ExpressionLimit	All set-ups	TRUE	67	UInt16
20-83	PID Start Speed [Hz]	ExpressionLimit	All set-ups	TRUE	-1	UInt16
20-84	On Reference Bandwidth	5 %	All set-ups	TRUE	0	UInt8
20-9* PID Controller						

Par. No. #	Parameter description	Default value	4-set-up	Change during operation	Conversion index	Type
20-91	PID Anti Windup	[1] On	All set-ups	TRUE	-	Uint8
20-93	PID Proportional Gain	0.50 N/A	All set-ups	TRUE	-2	Uint16
20-94	PID Integral Time	30 s	All set-ups	TRUE	-2	Uint32
20-95	PID Differentiation Time	0 s	All set-ups	TRUE	-2	Uint16
20-96	PID Diff. Gain Limit	5 N/A	All set-ups	TRUE	-1	Uint16

Table 4.17

4.1.17 21-** Ext. Closed Loop

Par. No. #	Parameter description	Default value	4-set-up	Change during operation	Conversion index	Type
21-0* Ext. CL Autotuning						
21-00	Closed Loop Type	[0] Auto	2 set-ups	TRUE	-	Uint8
21-01	PID Performance	[0] Normal	2 set-ups	TRUE	-	Uint8
21-02	PID Output Change	0.10 N/A	2 set-ups	TRUE	-2	Uint16
21-03	Minimum Feedback Level	-999999 N/A	2 set-ups	TRUE	-3	Int32
21-04	Maximum Feedback Level	999999 N/A	2 set-ups	TRUE	-3	Int32
21-09	PID Autotuning	[0] Disabled	All set-ups	TRUE	-	Uint8
21-1* Ext. CL 1 Ref./Fb.						
21-10	Ext. 1 Ref./Feedback Unit	[1] %	All set-ups	TRUE	-	Uint8
21-11	Ext. 1 Minimum Reference	0 ExtPID1Unit	All set-ups	TRUE	-3	Int32
21-12	Ext. 1 Maximum Reference	100 ExtPID1Unit	All set-ups	TRUE	-3	Int32
21-13	Ext. 1 Reference Source	[0] No function	All set-ups	TRUE	-	Uint8
21-14	Ext. 1 Feedback Source	[0] No function	All set-ups	TRUE	-	Uint8
21-15	Ext. 1 Setpoint	0 ExtPID1Unit	All set-ups	TRUE	-3	Int32
21-17	Ext. 1 Reference [Unit]	0 ExtPID1Unit	All set-ups	TRUE	-3	Int32
21-18	Ext. 1 Feedback [Unit]	0 ExtPID1Unit	All set-ups	TRUE	-3	Int32
21-19	Ext. 1 Output [%]	0 %	All set-ups	TRUE	0	Int32
21-2* Ext. CL 1 PID						
21-20	Ext. 1 Normal/Inverse Control	[0] Normal	All set-ups	TRUE	-	Uint8
21-21	Ext. 1 Proportional Gain	0.01 N/A	All set-ups	TRUE	-2	Uint16
21-22	Ext. 1 Integral Time	10000 s	All set-ups	TRUE	-2	Uint32
21-23	Ext. 1 Differentiation Time	0 s	All set-ups	TRUE	-2	Uint16
21-24	Ext. 1 Dif. Gain Limit	5 N/A	All set-ups	TRUE	-1	Uint16
21-3* Ext. CL 2 Ref./Fb.						
21-30	Ext. 2 Ref./Feedback Unit	[1] %	All set-ups	TRUE	-	Uint8
21-31	Ext. 2 Minimum Reference	0 ExtPID2Unit	All set-ups	TRUE	-3	Int32
21-32	Ext. 2 Maximum Reference	100 ExtPID2Unit	All set-ups	TRUE	-3	Int32
21-33	Ext. 2 Reference Source	[0] No function	All set-ups	TRUE	-	Uint8
21-34	Ext. 2 Feedback Source	[0] No function	All set-ups	TRUE	-	Uint8
21-35	Ext. 2 Setpoint	0 ExtPID2Unit	All set-ups	TRUE	-3	Int32
21-37	Ext. 2 Reference [Unit]	0 ExtPID2Unit	All set-ups	TRUE	-3	Int32
21-38	Ext. 2 Feedback [Unit]	0 ExtPID2Unit	All set-ups	TRUE	-3	Int32
21-39	Ext. 2 Output [%]	0 %	All set-ups	TRUE	0	Int32
21-4* Ext. CL 2 PID						
21-40	Ext. 2 Normal/Inverse Control	[0] Normal	All set-ups	TRUE	-	Uint8
21-41	Ext. 2 Proportional Gain	0.01 N/A	All set-ups	TRUE	-2	Uint16
21-42	Ext. 2 Integral Time	10000 s	All set-ups	TRUE	-2	Uint32
21-43	Ext. 2 Differentiation Time	0 s	All set-ups	TRUE	-2	Uint16

Par. No. #	Parameter description	Default value	4-set-up	Change during operation	Conversion index	Type
21-44	Ext. 2 Dif. Gain Limit	5 N/A	All set-ups	TRUE	-1	Uint16
21-5* Ext. CL 3 Ref./Fb.						
21-50	Ext. 3 Ref./Feedback Unit	[1] %	All set-ups	TRUE	-	Uint8
21-51	Ext. 3 Minimum Reference	0 ExtPID3Unit	All set-ups	TRUE	-3	Int32
21-52	Ext. 3 Maximum Reference	100 ExtPID3Unit	All set-ups	TRUE	-3	Int32
21-53	Ext. 3 Reference Source	[0] No function	All set-ups	TRUE	-	Uint8
21-54	Ext. 3 Feedback Source	[0] No function	All set-ups	TRUE	-	Uint8
21-55	Ext. 3 Setpoint	0 ExtPID3Unit	All set-ups	TRUE	-3	Int32
21-57	Ext. 3 Reference [Unit]	0 ExtPID3Unit	All set-ups	TRUE	-3	Int32
21-58	Ext. 3 Feedback [Unit]	0 ExtPID3Unit	All set-ups	TRUE	-3	Int32
21-59	Ext. 3 Output [%]	0 %	All set-ups	TRUE	0	Int32
21-6* Ext. CL 3 PID						
21-60	Ext. 3 Normal/Inverse Control	[0] Normal	All set-ups	TRUE	-	Uint8
21-61	Ext. 3 Proportional Gain	0.01 N/A	All set-ups	TRUE	-2	Uint16
21-62	Ext. 3 Integral Time	10000 s	All set-ups	TRUE	-2	Uint32
21-63	Ext. 3 Differentiation Time	0 s	All set-ups	TRUE	-2	Uint16
21-64	Ext. 3 Dif. Gain Limit	5 N/A	All set-ups	TRUE	-1	Uint16

Table 4.18

4.1.18 22-** Application Functions

Par. No. #	Parameter description	Default value	4-set-up	Change during operation	Conversion index	Type
22-0* Miscellaneous						
22-00	External Interlock Delay	0 s	All set-ups	TRUE	0	Uint16
22-2* No-Flow Detection						
22-20	Low Power Auto Set-up	[0] Off	All set-ups	FALSE	-	Uint8
22-21	Low Power Detection	[0] Disabled	All set-ups	TRUE	-	Uint8
22-22	Low Speed Detection	[0] Disabled	All set-ups	TRUE	-	Uint8
22-23	No-Flow Function	[0] Off	All set-ups	TRUE	-	Uint8
22-24	No-Flow Delay	10 s	All set-ups	TRUE	0	Uint16
22-26	Dry Pump Function	[0] Off	All set-ups	TRUE	-	Uint8
22-27	Dry Pump Delay	10 s	All set-ups	TRUE	0	Uint16
22-3* No-Flow Power Tuning						
22-30	No-Flow Power	0 kW	All set-ups	TRUE	1	Uint32
22-31	Power Correction Factor	100 %	All set-ups	TRUE	0	Uint16
22-32	Low Speed [RPM]	ExpressionLimit	All set-ups	TRUE	67	Uint16
22-33	Low Speed [Hz]	ExpressionLimit	All set-ups	TRUE	-1	Uint16
22-34	Low Speed Power [kW]	ExpressionLimit	All set-ups	TRUE	1	Uint32
22-35	Low Speed Power [HP]	ExpressionLimit	All set-ups	TRUE	-2	Uint32
22-36	High Speed [RPM]	ExpressionLimit	All set-ups	TRUE	67	Uint16
22-37	High Speed [Hz]	ExpressionLimit	All set-ups	TRUE	-1	Uint16
22-38	High Speed Power [kW]	ExpressionLimit	All set-ups	TRUE	1	Uint32
22-39	High Speed Power [HP]	ExpressionLimit	All set-ups	TRUE	-2	Uint32
22-4* Sleep Mode						
22-40	Minimum Run Time	10 s	All set-ups	TRUE	0	Uint16
22-41	Minimum Sleep Time	10 s	All set-ups	TRUE	0	Uint16
22-42	Wake-up Speed [RPM]	ExpressionLimit	All set-ups	TRUE	67	Uint16
22-43	Wake-up Speed [Hz]	ExpressionLimit	All set-ups	TRUE	-1	Uint16

22-44	Wake-up Ref./FB Difference	10 %	All set-ups	TRUE	0	Int8
22-45	Setpoint Boost	0 %	All set-ups	TRUE	0	Int8
22-46	Maximum Boost Time	60 s	All set-ups	TRUE	0	Uint16
22-5* End of Curve						
22-50	End of Curve Function	[0] Off	All set-ups	TRUE	-	Uint8
22-51	End of Curve Delay	10 s	All set-ups	TRUE	0	Uint16
22-6* Broken Belt Detection						
22-60	Broken Belt Function	[0] Off	All set-ups	TRUE	-	Uint8
22-61	Broken Belt Torque	10 %	All set-ups	TRUE	0	Uint8
22-62	Broken Belt Delay	10 s	All set-ups	TRUE	0	Uint16
22-7* Short Cycle Protection						
22-75	Short Cycle Protection	[0] Disabled	All set-ups	TRUE	-	Uint8
22-76	Interval between Starts	300 s	All set-ups	TRUE	0	Uint16
22-77	Minimum Run Time	0 s	All set-ups	TRUE	0	Uint16
22-78	Minimum Run Time Override	[0] Disabled	All set-ups	FALSE	-	Uint8
22-79	Minimum Run Time Override Value	0 ProcessCtrlUnit	All set-ups	TRUE	-3	Int32
22-8* Flow Compensation						
22-80	Flow Compensation	[0] Disabled	All set-ups	TRUE	-	Uint8
22-81	Square-linear Curve Approximation	100 %	All set-ups	TRUE	0	Uint8
22-82	Work Point Calculation	[0] Disabled	All set-ups	TRUE	-	Uint8
22-83	Speed at No-Flow [RPM]	ExpressionLimit	All set-ups	TRUE	67	Uint16
22-84	Speed at No-Flow [Hz]	ExpressionLimit	All set-ups	TRUE	-1	Uint16
22-85	Speed at Design Point [RPM]	ExpressionLimit	All set-ups	TRUE	67	Uint16
22-86	Speed at Design Point [Hz]	ExpressionLimit	All set-ups	TRUE	-1	Uint16
22-87	Pressure at No-Flow Speed	0 N/A	All set-ups	TRUE	-3	Int32
22-88	Pressure at Rated Speed	999999 N/A	All set-ups	TRUE	-3	Int32
22-89	Flow at Design Point	0 N/A	All set-ups	TRUE	-3	Int32
22-90	Flow at Rated Speed	0 N/A	All set-ups	TRUE	-3	Int32

Table 4.19

4.1.19 23-** Time Based Functions

Par. No. #	Parameter description	Default value	4-set-up	Change during operation	Conversion index	Type
23-0* Timed Actions						
23-00	ON Time	ExpressionLimit	2 set-ups	TRUE	0	TimeOfDay-WoDate
23-01	ON Action	[0] Disabled	2 set-ups	TRUE	-	Uint8
23-02	OFF Time	ExpressionLimit	2 set-ups	TRUE	0	TimeOfDay-WoDate
23-03	OFF Action	[0] Disabled	2 set-ups	TRUE	-	Uint8
23-04	Occurrence	[0] All days	2 set-ups	TRUE	-	Uint8
23-1* Maintenance						
23-10	Maintenance Item	[1] Motor bearings	1 set-up	TRUE	-	Uint8
23-11	Maintenance Action	[1] Lubricate	1 set-up	TRUE	-	Uint8
23-12	Maintenance Time Base	[0] Disabled	1 set-up	TRUE	-	Uint8
23-13	Maintenance Time Interval	1 h	1 set-up	TRUE	74	Uint32
23-14	Maintenance Date and Time	ExpressionLimit	1 set-up	TRUE	0	TimeOfDay
23-1* Maintenance Reset						
23-15	Reset Maintenance Word	[0] Do not reset	All set-ups	TRUE	-	Uint8

Par. No. #	Parameter description	Default value	4-set-up	Change during operation	Conversion index	Type
23-16	Maintenance Text	0 N/A	1 set-up	TRUE	0	VisStr[20]
23-5* Energy Log						
23-50	Energy Log Resolution	[5] Last 24 Hours	2 set-ups	TRUE	-	UInt8
23-51	Period Start	ExpressionLimit	2 set-ups	TRUE	0	TimeOfDay
23-53	Energy Log	0 N/A	All set-ups	TRUE	0	UInt32
23-54	Reset Energy Log	[0] Do not reset	All set-ups	TRUE	-	UInt8
23-6* Trending						
23-60	Trend Variable	[0] Power [kW]	2 set-ups	TRUE	-	UInt8
23-61	Continuous Bin Data	0 N/A	All set-ups	TRUE	0	UInt32
23-62	Timed Bin Data	0 N/A	All set-ups	TRUE	0	UInt32
23-63	Timed Period Start	ExpressionLimit	2 set-ups	TRUE	0	TimeOfDay
23-64	Timed Period Stop	ExpressionLimit	2 set-ups	TRUE	0	TimeOfDay
23-65	Minimum Bin Value	ExpressionLimit	2 set-ups	TRUE	0	UInt8
23-66	Reset Continuous Bin Data	[0] Do not reset	All set-ups	TRUE	-	UInt8
23-67	Reset Timed Bin Data	[0] Do not reset	All set-ups	TRUE	-	UInt8
23-8* Payback Counter						
23-80	Power Reference Factor	100 %	2 set-ups	TRUE	0	UInt8
23-81	Energy Cost	1 N/A	2 set-ups	TRUE	-2	UInt32
23-82	Investment	0 N/A	2 set-ups	TRUE	0	UInt32
23-83	Energy Savings	0 kWh	All set-ups	TRUE	75	Int32
23-84	Cost Savings	0 N/A	All set-ups	TRUE	0	Int32

Table 4.20

4.1.20 25-** Pack Controller

Par. No. #	Parameter description	Default value	4-set-up	Change during operation	Conversion index	Type
25-0* System Settings						
25-00	Pack Controller	[0] Disabled	2 set-ups	FALSE	-	UInt8
25-04	Compressor Cycling	[0] Disabled	All set-ups	TRUE	-	UInt8
25-06	Number of Compressors	2 N/A	2 set-ups	FALSE	0	UInt8
25-2* Zone Settings						
25-20	Neutral Zone [unit]	4 ReferenceFeed-backUnit	All set-ups	TRUE	-2	UInt32
25-21	+ Zone [unit]	3 ReferenceFeed-backUnit	All set-ups	TRUE	-2	UInt32
25-22	- Zone [unit]	3 ReferenceFeed-backUnit	All set-ups	TRUE	-2	UInt32
25-23	Fixed Speed neutral Zone [unit]	4 ReferenceFeed-backUnit	All set-ups	TRUE	-2	UInt32
25-24	+ Zone Delay	120 s	All set-ups	TRUE	0	UInt32
25-25	- Zone Delay	60 s	All set-ups	TRUE	0	UInt32
25-26	++ Zone Delay	60 s	All set-ups	TRUE	0	UInt32
25-27	-- Zone Delay	30 s	All set-ups	TRUE	0	UInt32
25-3* Staging Functions						
25-30	Destage At No-Flow	[0] Disabled	All set-ups	TRUE	-	UInt8
25-31	Stage Function	[0] Disabled	All set-ups	TRUE	-	UInt8
25-32	Stage Function Time	15 s	All set-ups	TRUE	0	UInt16
25-33	Destage Function	[0] Disabled	All set-ups	TRUE	-	UInt8

25-34	Destage Function Time	15 s	All set-ups	TRUE	0	Uint16
25-4* Staging Settings						
25-42	Staging Threshold	ExpressionLimit	All set-ups	TRUE	0	Uint8
25-43	Destaging Threshold	ExpressionLimit	All set-ups	TRUE	0	Uint8
25-44	Staging Speed [RPM]	0 RPM	All set-ups	TRUE	67	Uint16
25-45	Staging Speed [Hz]	0 Hz	All set-ups	TRUE	-1	Uint16
25-46	Destaging Speed [RPM]	0 RPM	All set-ups	TRUE	67	Uint16
25-47	Destaging Speed [Hz]	0 Hz	All set-ups	TRUE	-1	Uint16
25-8* Status						
25-80	Pack Status	0 N/A	All set-ups	TRUE	0	VisStr[25]
25-81	Compressor Status	0 N/A	All set-ups	TRUE	0	VisStr[25]
25-82	Lead Compressor	0 N/A	All set-ups	TRUE	0	Uint8
25-83	Relay Status	0 N/A	All set-ups	TRUE	0	VisStr[4]
25-84	Compressor ON Time	0 h	All set-ups	TRUE	74	Uint32
25-85	Relay ON Time	0 h	All set-ups	TRUE	74	Uint32
25-86	Reset Relay Counters	[0] Do not reset	All set-ups	TRUE	-	Uint8
25-87	Inverse Interlock	0 N/A	All set-ups	TRUE	0	Uint16
25-88	Pack capacity [%]	0 %	All set-ups	TRUE	0	Uint16
25-9* Service						
25-90	Compressor Interlock	[0] Off	All set-ups	TRUE	-	Uint8
25-91	Manual Alternation	0 N/A	All set-ups	TRUE	0	Uint8

Table 4.21

4.1.21 26-** Analog I/O Option MCB 109

Par. No. #	Parameter description	Default value	4-set-up	Change during operation	Conversion index	Type
26-0* Analog I/O Mode						
26-00	Terminal X42/1 Mode	[1] Voltage	All set-ups	TRUE	-	Uint8
26-01	Terminal X42/3 Mode	[1] Voltage	All set-ups	TRUE	-	Uint8
26-02	Terminal X42/5 Mode	[1] Voltage	All set-ups	TRUE	-	Uint8
26-1* Analog Input X42/1						
26-10	Terminal X42/1 Low Voltage	0.07 V	All set-ups	TRUE	-2	Int16
26-11	Terminal X42/1 High Voltage	10 V	All set-ups	TRUE	-2	Int16
26-14	Term. X42/1 Low Ref./Feedb. Value	0 N/A	All set-ups	TRUE	-3	Int32
26-15	Term. X42/1 High Ref./Feedb. Value	100 N/A	All set-ups	TRUE	-3	Int32
26-16	Term. X42/1 Filter Time Constant	0.001 s	All set-ups	TRUE	-3	Uint16
26-17	Term. X42/1 Live Zero	[1] Enabled	All set-ups	TRUE	-	Uint8
26-2* Analog Input X42/3						
26-20	Terminal X42/3 Low Voltage	0.07 V	All set-ups	TRUE	-2	Int16
26-21	Terminal X42/3 High Voltage	10 V	All set-ups	TRUE	-2	Int16
26-24	Term. X42/3 Low Ref./Feedb. Value	0 N/A	All set-ups	TRUE	-3	Int32
26-25	Term. X42/3 High Ref./Feedb. Value	100 N/A	All set-ups	TRUE	-3	Int32
26-26	Term. X42/3 Filter Time Constant	0.001 s	All set-ups	TRUE	-3	Uint16
26-27	Term. X42/3 Live Zero	[1] Enabled	All set-ups	TRUE	-	Uint8
26-3* Analog Input X42/5						

Par. No. #	Parameter description	Default value	4-set-up	Change during operation	Conversion index	Type
26-30	Terminal X42/5 Low Voltage	0.07 V	All set-ups	TRUE	-2	Int16
26-31	Terminal X42/5 High Voltage	10 V	All set-ups	TRUE	-2	Int16
26-34	Term. X42/5 Low Ref./Feedb. Value	0 N/A	All set-ups	TRUE	-3	Int32
26-35	Term. X42/5 High Ref./Feedb. Value	100 N/A	All set-ups	TRUE	-3	Int32
26-36	Term. X42/5 Filter Time Constant	0.001 s	All set-ups	TRUE	-3	UInt16
26-37	Term. X42/5 Live Zero	[1] Enabled	All set-ups	TRUE	-	UInt8
26-4* Analog Out X42/7						
26-40	Terminal X42/7 Output	[0] No operation	All set-ups	TRUE	-	UInt8
26-41	Terminal X42/7 Min. Scale	0 %	All set-ups	TRUE	-2	Int16
26-42	Terminal X42/7 Max. Scale	100 %	All set-ups	TRUE	-2	Int16
26-43	Terminal X42/7 Bus Control	0 %	All set-ups	TRUE	-2	N2
26-44	Terminal X42/7 Timeout Preset	0 %	1 set-up	TRUE	-2	UInt16
26-5* Analog Out X42/9						
26-50	Terminal X42/9 Output	[0] No operation	All set-ups	TRUE	-	UInt8
26-51	Terminal X42/9 Min. Scale	0 %	All set-ups	TRUE	-2	Int16
26-52	Terminal X42/9 Max. Scale	100 %	All set-ups	TRUE	-2	Int16
26-53	Terminal X42/9 Bus Control	0 %	All set-ups	TRUE	-2	N2
26-54	Terminal X42/9 Timeout Preset	0 %	1 set-up	TRUE	-2	UInt16
26-6* Analog Out X42/11						
26-60	Terminal X42/11 Output	[0] No operation	All set-ups	TRUE	-	UInt8
26-61	Terminal X42/11 Min. Scale	0 %	All set-ups	TRUE	-2	Int16
26-62	Terminal X42/11 Max. Scale	100 %	All set-ups	TRUE	-2	Int16
26-63	Terminal X42/11 Bus Control	0 %	All set-ups	TRUE	-2	N2
26-64	Terminal X42/11 Timeout Preset	0 %	1 set-up	TRUE	-2	UInt16

Table 4.22

4.1.22 28-** Compressor Functions

Par. No. #	Parameter description	Default value	4-set-up	Change during operation	Conversion index	Type
28-2* Discharge Temperature Monitor						
28-20	Temperature Source	[0] None	All set-ups	FALSE	-	UInt8
28-21	Temperature Unit	[60] °C	All set-ups	FALSE	-	UInt8
28-24	Warning Level	130 N/A	All set-ups	FALSE	0	UInt16
28-25	Warning Action	[1] Decrease cooling	All set-ups	FALSE	-	UInt8
28-26	Emergency Level	145 N/A	All set-ups	FALSE	0	UInt16
28-27	Discharge Temperature	0 DTM_ReadoutUnit	All set-ups	TRUE	0	Int32
28-7* Day/Night Settings						
28-71	Day/Night Bus Indicator	[0] Day	All set-ups	TRUE	-	UInt8
28-72	Enable Day/Night Via Bus	[0] Disabled	All set-ups	TRUE	-	UInt8
28-73	Night Setback	0 ReferenceFeed-backUnit	All set-ups	TRUE	-3	Int32
28-74	Night Speed Drop [RPM]	ExpressionLimit	All set-ups	TRUE	67	UInt16
28-75	Night Speed Drop Override	0 N/A	All set-ups	TRUE	-3	Int32
28-76	Night Speed Drop [Hz]	ExpressionLimit	All set-ups	TRUE	-1	UInt16
28-8* P0 Optimization						

Par. No. #	Parameter description	Default value	4-set-up	Change during operation	Conversion index	Type
28-81	dP0 Offset	0 K	All set-ups	TRUE	-1	Int32
28-82	P0	0 K	All set-ups	TRUE	-3	Int32
28-83	P0 Setpoint	0 K	All set-ups	TRUE	-3	Int32
28-84	P0 Reference	0 K	All set-ups	TRUE	-3	Int32
28-85	P0 Minimum Reference	0 K	All set-ups	TRUE	0	Int32
28-86	P0 Maximum Reference	0 K	All set-ups	TRUE	0	Int32
28-87	Most Loaded Controller	0 N/A	All set-ups	TRUE	0	Int16
28-9* Injection Control						
28-90	Injection On	[0] Off	All set-ups	TRUE	-	UInt8
28-91	Delayed Compressor Start	[0] No	All set-ups	TRUE	-	UInt8

Table 4.23

5 Troubleshooting

5.1.1 Alarms and Warnings

A warning or an alarm is signalled by the relevant LED on the front of the frequency converter and indicated by a code on the display.

A warning remains active until its cause is no longer present. Under certain circumstances operation of the motor may still be continued. Warning messages may be critical, but are not necessarily so.

In the event of an alarm, the frequency converter will have tripped. Alarms must be reset to restart operation once their cause has been rectified. This may be done in four ways:

1. By pressing [Reset].
2. Via a digital input with the "Reset" function.
3. Via serial communication/optional fieldbus.
4. By resetting automatically using the [Auto Reset] function, see *14-20 Reset Mode*.

NOTE

After a manual reset pressing [Reset], [Auto On] must be pressed to restart the motor.

If an alarm cannot be reset, the reason may be that its cause has not been rectified, or the alarm is trip-locked (see also *Table 5.1*).

Alarms that are trip-locked offer additional protection, means that the mains supply must be switched off before the alarm can be reset. After being switched back on, the frequency converter is no longer blocked and may be reset as described above once the cause has been rectified.

Alarms that are not trip-locked can also be reset using the automatic reset function in *14-20 Reset Mode* (Warning: automatic wake-up is possible!)

If a warning and alarm is marked against a code in *Table 5.1*, this means that either a warning occurs before an alarm, or it can be specified whether it is a warning or an alarm that is to be displayed for a given fault.

This is possible, for instance, in *1-90 Motor Thermal Protection*. After an alarm or trip, the motor carries on coasting, and the alarm and warning flash on the frequency converter. Once the problem has been rectified, only the alarm continues flashing.

No.	Description	Warning	Alarm/Trip	Alarm/Trip Lock	Parameter Reference
1	10 Volts low	X			
2	Live zero error	(X)	(X)		6-01
3	No motor	(X)			1-80
4	Mains phase loss	(X)	(X)	(X)	14-12
5	DC link voltage high	X			
6	DC link voltage low	X			
7	DC over voltage	X	X		
8	DC under voltage	X	X		
9	Inverter overloaded	X	X		
10	Motor ETR over temperature	(X)	(X)		1-90
11	Motor thermistor over temperature	(X)	(X)		1-90
12	Torque limit	X	X		
13	Over Current	X	X	X	
14	Earth fault	X	X	X	
15	Incomp. HW		X	X	
16	Short Circuit		X	X	
17	Control word timeout	(X)	(X)		8-04
18	Start Failed				
19	Discharge Temperature High				
23	Internal fans				
24	External fans				
25	Brake resistor short-circuited	X			
26	Brake resistor power limit	(X)	(X)		2-13

No.	Description	Warning	Alarm/Trip	Alarm/Trip Lock	Parameter Reference
27	Brake chopper short-circuited	X	X		
28	Brake check	(X)	(X)		2-15
29	Power board over temp	X	X	X	
30	Motor phase U missing	(X)	(X)	(X)	4-58
31	Motor phase V missing	(X)	(X)	(X)	4-58
32	Motor phase W missing	(X)	(X)	(X)	4-58
33	Inrush fault		X	X	
34	Fieldbus communication fault	X	X		
36	Mains failure				
38	Internal fault		X	X	
40	Overload T27				
41	Overload T29				
42	Overload X30/6-7				
47	24 V supply low	X	X	X	
48	1.8 V supply low		X	X	
49	Speed limit				
50	AMA calibration failed		X		
51	AMA check U _{nom} and I _{nom}		X		
52	AMA low I _{nom}		X		
53	AMA motor too big		X		
54	AMA motor too small		X		
55	AMA parameter out of range		X		
56	AMA interrupted by user		X		
57	AMA timeout		X		
58	AMA internal fault	X	X		
59	Current limit	X			
60	External interlock				
62	Output Frequency at Maximum Limit	X			
64	Voltage Limit	X			
65	Control Board Over-temperature	X	X	X	
66	Heat sink Temperature Low	X			
67	Option Configuration has Changed		X		
68	Safe Stop Activated		X		
70	Illegal FC configuration				
80	Drive Initialised to Default Value		X		
92	No-Flow	X	X		22-2*
93	Dry Pump	X	X		22-2*
94	End of Curve	X	X		22-5*
95	Broken Belt	X	X		22-6*
96	Start Delayed	X			22-7*
97	Stop Delayed	X			22-7*
98	Clock Fault	X			0-7*
250	New spare part				
251	New type code				

Table 5.1 Alarm/Warning Code List
(X) Dependent on parameter

Warning	yellow
Alarm	flashing red
Trip locked	yellow and red

Table 5.2 LED Indication

Alarm Word and Extended Status Word					
Bit	Hex	Dec	Alarm Word	Warning Word	Extended Status Word
0	00000001	1	Brake Check	Brake Check	Ramping
1	00000002	2	Pwr. Card Temp	Pwr. Card Temp	AMA Running
2	00000004	4	Earth Fault	Earth Fault	Start CW/CCW
3	00000008	8	Ctrl.Card Temp	Ctrl.Card Temp	Slow Down
4	00000010	16	Ctrl. Word TO	Ctrl. Word TO	Catch Up
5	00000020	32	Over Current	Over Current	Feedback High
6	00000040	64	Torque Limit	Torque Limit	Feedback Low
7	00000080	128	Motor Th Over	Motor Th Over	Output Current High
8	00000100	256	Motor ETR Over	Motor ETR Over	Output Current Low
9	00000200	512	Inverter Overld.	Inverter Overld.	Output Freq High
10	00000400	1024	DC under Volt	DC under Volt	Output Freq Low
11	00000800	2048	DC over Volt	DC over Volt	Brake Check OK
12	00001000	4096	Short Circuit	DC Voltage Low	Braking Max
13	00002000	8192	Inrush Fault	DC Voltage High	Braking
14	00004000	16384	Mains ph. Loss	Mains ph. Loss	Out of Speed Range
15	00008000	32768	AMA Not OK	No Motor	OVC Active
16	00010000	65536	Live Zero Error	Live Zero Error	
17	00020000	131072	Internal Fault	10V Low	
18	00040000	262144	Brake Overload	Brake Overload	
19	00080000	524288	U phase Loss	Brake Resistor	
20	00100000	1048576	V phase Loss	Brake IGBT	
21	00200000	2097152	W phase Loss	Speed Limit	
22	00400000	4194304	Fieldbus Fault	Fieldbus Fault	
23	00800000	8388608	24 V Supply Low	24V Supply Low	
24	01000000	16777216	Mains Failure	Mains Failure	
25	02000000	33554432	1.8V Supply Low	Current Limit	
26	04000000	67108864	Brake Resistor	Low Temp	
27	08000000	134217728	Brake IGBT	Voltage Limit	
28	10000000	268435456	Option Change	Unused	
29	20000000	536870912	Drive Initialised	Unused	
30	40000000	1073741824	Safe Stop	Unused	

Table 5.3 Description of Alarm Word, Warning Word and Extended Status Word

The alarm words, warning words and extended status words can be read out via serial bus or optional fieldbus for diagnosis. See also *16-90 Alarm Word*, *16-92 Warning Word* and *16-94 Ext. Status Word*.

Description of Alarm Word 2 and Warning Word 2				
Bit	Hex	Dec	Alarm Word 2	Warning Word 2
0	00000001	1		Start Delayed
1	00000002	2		Stop Delayed
9	00000200	512	Discharge Temperature High	Discharge Temperature High
10	00000400	1024	Start Failed	
11	00000800	2048	Speed Limit	

Table 5.4 Compressor Specific Alarms and Warnings

5.1.2 Alarm Words

5

Bit (Hex)	Alarm Word (16-90 Alarm Word)
00000001	
00000002	Power card over temperature
00000004	Earth fault
00000008	
00000010	Control word timeout
00000020	Over current
00000040	
00000080	Motor thermistor over temp.
00000100	Motor ETR over temperature
00000200	Inverter overloaded
00000400	DC link under voltage
00000800	DC link over voltage
00001000	Short circuit
00002000	
00004000	Mains phase loss
00008000	AMA not OK
00010000	Live zero error
00020000	Internal fault
00040000	
00080000	Motor phase U is missing
00100000	Motor phase V is missing
00200000	Motor phase W is missing
00800000	Control Voltage Fault
01000000	
02000000	VDD, supply low
04000000	Brake resistor short circuit
08000000	Brake chopper fault
10000000	Earth fault DESAT
20000000	Drive initialised
40000000	Safe Stop [A68]
80000000	

Table 5.5 16-90 Alarm Word

Bit (Hex)	Alarm Word 2 (16-91 Alarm Word 2)
00000001	
00000002	Reserved
00000004	Service Trip, Typecode / Sparepart
00000008	Reserved
00000010	Reserved
00000020	
00000040	
00000080	
00000100	Broken Belt
00000200	Not used
00000400	Not used
00000800	Reserved
00001000	Reserved
00002000	Reserved
00004000	Reserved
00008000	Reserved
00010000	Reserved
00020000	Not used
00040000	Fans error
00080000	ECB error
00100000	Reserved
00200000	Reserved
00400000	Reserved
00800000	Reserved
01000000	Reserved
02000000	Reserved
04000000	Reserved
08000000	Reserved
10000000	Reserved
20000000	Reserved
40000000	PTC 1 Safe Stop [A71]
80000000	Dangerous Failure [A72]

Table 5.6 16-91 Alarm Word 2

5.1.3 Warning Words

Bit (Hex)	Warning Word (16-92 Warning Word)
00000001	
00000002	Power card over temperature
00000004	Earth fault
00000008	
00000010	Control word timeout
00000020	Over current
00000040	
00000080	Motor thermistor over temp.
00000100	Motor ETR over temperature
00000200	Inverter overloaded
00000400	DC link under voltage
00000800	DC link over voltage
00001000	
00002000	
00004000	Mains phase loss
00008000	No motor
00010000	Live zero error
00020000	
00040000	
00080000	
00100000	
00200000	
00400000	
00800000	
01000000	
02000000	Current limit
04000000	
08000000	
10000000	
20000000	
40000000	Safe Stop [W68]
80000000	Not used

Table 5.7 16-92 Warning Word

Bit (Hex)	Warning Word 2 (16-93 Warning Word 2)
00000001	
00000002	
00000004	Clock Failure
00000008	Reserved
00000010	Reserved
00000020	
00000040	
00000080	End of Curve
00000100	Broken Belt
00000200	Not used
00000400	Reserved
00000800	Reserved
00001000	Reserved
00002000	Reserved
00004000	Reserved
00008000	Reserved
00010000	Reserved
00020000	Not used
00040000	Fans warning
00080000	
00100000	Reserved
00200000	Reserved
00400000	Reserved
00800000	Reserved
01000000	Reserved
02000000	Reserved
04000000	Reserved
08000000	Reserved
10000000	Reserved
20000000	Reserved
40000000	PTC 1 Safe Stop [W71]
80000000	Reserved

Table 5.8 16-93 Warning Word 2

5.1.4 Extended Status Words

5

Bit (Hex)	Extended Status Word (16-94 Ext. Status Word)
00000001	Ramping
00000002	AMA tuning
00000004	Start CW/CCW
00000008	Not used
00000010	Not used
00000020	Feedback high
00000040	Feedback low
00000080	Output current high
00000100	Output current low
00000200	Output frequency high
00000400	Output frequency low
00000800	Brake check OK
00001000	Braking max
00002000	Braking
00004000	Out of speed range
00008000	OVC active
00010000	AC brake
00020000	Password Timelock
00040000	Password Protection
00080000	Reference high
00100000	Reference low
00200000	Local Ref./Remote Ref.
00400000	Reserved
00800000	Reserved
01000000	Reserved
02000000	Reserved
04000000	Reserved
08000000	Reserved
10000000	Reserved
20000000	Reserved
40000000	Reserved
80000000	Reserved

Table 5.9 Extended Status Word, 16-94 Ext. Status Word

Bit (Hex)	Extended Status Word 2 (16-95 Ext. Status Word 2)
00000001	Off
00000002	Hand / Auto
00000004	Not used
00000008	Not used
00000010	Not used
00000020	Relay 123 active
00000040	Start Prevented
00000080	Control ready
00000100	Drive ready
00000200	Quick Stop
00000400	DC Brake
00000800	Stop
00001000	Standby
00002000	Freeze Output Request
00004000	Freeze Output
00008000	Jog Request
00010000	Jog
00020000	Start Request
00040000	Start
00080000	Start Applied
00100000	Start Delay
00200000	Sleep
00400000	Sleep Boost
00800000	Running
01000000	Bypass
02000000	Fire Mode
04000000	Reserved
08000000	Reserved
10000000	Reserved
20000000	Reserved
40000000	Reserved
80000000	Reserved

Table 5.10 Extended Status Word 2, 16-95 Ext. Status Word 2

5.1.5 Fault Messages

WARNING 1, 10 Volts low

The 10 V voltage from terminal 50 on the control card is below 10 V.

Remove some of the load from terminal 50, as the 10 V supply is overloaded. Max. 15 mA or minimum 590 Ω.

WARNING/ALARM 2, Live zero error

The signal on terminal 53 or 54 is less than 50% of the value set in *6-10 Terminal 53 Low Voltage*, *6-12 Terminal 53 Low Current*, *6-20 Terminal 54 Low Voltage* or *6-22 Terminal 54 Low Current* respectively.

WARNING/ALARM 3, No motor

No motor has been connected to the output of the frequency converter.

WARNING/ALARM 4, Mains phase loss

A phase is missing on the supply side, or the mains voltage imbalance is too high.

This message also appears in case of a fault in the input rectifier on the frequency converter.

Check the supply voltage and supply currents to the frequency converter.

WARNING 5, DC link voltage high

The intermediate circuit voltage (DC) is higher than the overvoltage limit of the control system. The frequency converter is still active.

WARNING 6, DC link voltage low

The intermediate circuit voltage (DC) is below the undervoltage limit of the control system. The frequency converter is still active.

WARNING/ALARM 7, DC over voltage

If the intermediate circuit voltage exceeds the limit, the frequency converter trips after a time.

Possible corrections:

Select **Over Voltage Control** function in *2-17 Over-voltage Control*

Connect a brake resistor

Extend the ramp time

Activate functions in *2-10 Brake Function*

Increase *14-26 Trip Delay at Inverter Fault*

Selecting OVC function will extend the ramp times.

FC 103	3 x 200-240 V AC	3 x 380-500 V AC
	[V DC]	[V DC]
Undervoltage	185	373
Voltage warning low	205	410
Voltage warning high (w/o brake - w/brake)	390/405	810/840
Overvoltage	410	855
The voltages stated are the intermediate circuit voltage of the frequency converter with a tolerance of ±5 %. The corresponding mains voltage is the intermediate circuit voltage (DC-link) divided by 1.35		

Table 5.11 Alarm/Warning Limits

WARNING/ALARM 8, DC under voltage

If the intermediate circuit voltage (DC) drops below the "voltage warning low" limit (see *Table 5.11*), the frequency converter checks if 24 V backup supply is connected.

If no 24 V backup supply is connected, the frequency converter trips after a given time depending on the unit. To check whether the supply voltage matches the frequency converter, see *General Specifications* in the VLT Refrigeration Drive FC 103 Design Guide.

WARNING/ALARM 9, Inverter overloaded

The frequency converter is about to cut out because of an overload (too high current for too long). The counter for electronic, thermal inverter protection gives a warning at 98% and trips at 100%, while giving an alarm. The frequency converter cannot be reset until the counter is below 90%.

The fault is that the frequency converter is overloaded by more than nominal current for too long.

WARNING/ALARM 10, Motor ETR over temperature

According to the electronic thermal protection (ETR), the motor is too hot. You can choose if you want the frequency converter to give a warning or an alarm when the counter reaches 100% in *1-90 Motor Thermal Protection*. The fault is that the motor is overloaded by more than nominal current for too long. Check that *1-24 Motor Current* is set correctly.

WARNING/ALARM 11, Motor thermistor over temp

The thermistor or the thermistor connection is disconnected. You can choose if you want the frequency converter to give a warning or an alarm in *1-90 Motor Thermal Protection*. Check that the thermistor is connected correctly between terminal 53 or 54 (analog voltage input) and terminal 50 (+ 10 V supply), or between terminal 18 or 19 (digital input PNP only) and terminal 50. If a KTY sensor is used, check for correct connection between terminal 54 and 55.

WARNING/ALARM 12, Torque limit

The torque is higher than the value in *4-16 Torque Limit Motor Mode* (in motor operation) or the torque is higher than the value in *4-17 Torque Limit Generator Mode* (in regenerative operation).

WARNING/ALARM 13, Over Current

The inverter peak current limit (approx. 200% of the rated current) is exceeded. The warning will last approx. 8-12 s, then the frequency converter trips and issues an alarm. Turn off the frequency converter and check if the motor shaft can be turned and if the motor size matches the frequency converter.

ALARM 14, Earth fault

There is a discharge from the output phases to earth, either in the cable between the frequency converter and the motor or in the motor itself.

Turn off the frequency converter and remove the earth fault.

ALARM 15, In-complete hardware

A fitted option is not handled by the present control board (hardware or software).

ALARM 16, Short-circuit

There is short-circuiting in the motor or on the motor terminals.

Turn off the frequency converter and remove the short-circuit.

WARNING/ALARM 17, Control word timeout

There is no communication to the frequency converter.

The warning will only be active when *8-04 Control Timeout Function* is NOT set to [0] Off.

If *8-04 Control Timeout Function* is set to [5] Stop and Trip, a warning appears and the frequency converter ramps down to zero speed, while giving an alarm.

8-03 Control Timeout Time could possibly be increased.

ALARM 18, Start Failed

The speed has not been able to exceed *1-77 Compressor Start Max Speed [RPM]* during the start within the allowed time *1-79 Compressor Start Max Time to Trip*. This may be caused by a blocked rotor.

WARNING 19, Discharge Temperature High

The discharge temperature exceeds the level programmed in *28-24 Warning Level*. If so programmed in *28-25 Warning Action* the frequency converter lowers the speed of the compressor in an attempt to lower the discharge temperature.

ALARM 19, Discharge Temperature High

The discharge temperature exceeds the level programmed in *28-26 Emergency Level*.

WARNING 23, Internal fans

External fans have failed due to defect hardware or fans not mounted.

WARNING 24, External fan fault

The fan warning function is an extra protection function that checks if the fan is running/mounted. The fan warning can be disabled in *14-53 Fan Monitor*, [0] Disabled.

WARNING 25, Brake resistor short-circuited

The brake resistor is monitored during operation. If it short-circuits, the brake function is disconnected and the warning appears. The frequency converter still works, but

without the brake function. Turn off the frequency converter and replace the brake resistor (see *2-15 Brake Check*).

ALARM/WARNING 26, Brake resistor power limit

The power transmitted to the brake resistor is calculated as a percentage, as a mean value over the last 120 s, on the basis of the resistance value of the brake resistor (*2-11 Brake Resistor (ohm)*) and the intermediate circuit voltage. The warning is active when the dissipated braking power is higher than 90%. If [2] Trip has been selected in *2-13 Brake Power Monitoring*, the frequency converter cuts out and issues this alarm, when the dissipated braking power is higher than 100%.

WARNING/ALARM 27, Brake chopper fault

The brake transistor is monitored during operation and if it short-circuits, the brake function disconnects and the warning comes up. The frequency converter is still able to run, but since the brake transistor has short-circuited, substantial power is transmitted to the brake resistor, even if it is inactive.

Turn off the frequency converter and remove the brake resistor.

WARNING

There is a risk of substantial power being transmitted to the brake resistor if the brake transistor is short-circuited.

ALARM/WARNING 28, Brake check failed

Brake resistor fault: the brake resistor is not connected/working.

WARNING/ALARM 29, Drive over temperature

If the enclosure is IP00, IP20/Nema 1 or IP21/TYP 1, the cut-out temperature of the heat-sink is 95 °C +5 °C. The temperature fault cannot be reset, until the temperature of the heatsink is below 70 °C.

The fault could be

- Ambient temperature too high
- Too long motor cable

ALARM 30, Motor phase U missing

Motor phase U between the frequency converter and the motor is missing.

Turn off the frequency converter and check motor phase U.

ALARM 31, Motor phase V missing

Motor phase V between the frequency converter and the motor is missing.

Turn off the frequency converter and check motor phase V.

ALARM 32, Motor phase W missing

Motor phase W between the frequency converter and the motor is missing.

Turn off the frequency converter and check motor phase W.

ALARM 33, Inrush fault

Too many powerups have occurred within a short time period. See *General Specifications* in the VLT Refrigeration Drive FC 103 Design Guide for the allowed number of power-ups within one minute.

WARNING/ALARM 34, Fieldbus communication fault

The fieldbus on the communication option card is not working.

WARNING/ALARM 36, Mains failure

This warning/alarm is only active if the supply voltage to the frequency converter is lost and *14-10 Mains Failure* is NOT set to [0] *No function*. Possible correction: check the fuses to the frequency converter

ALARM 38, Internal fault

Contact your local Danfoss supplier.

WARNING 40, Overload of Digital Output Terminal 27

Check the load connected to terminal 27 or remove short-circuit connection. Check *5-00 Digital I/O Mode* and *5-01 Terminal 27 Mode*.

WARNING 41, Overload of Digital Output Terminal 29

Check the load connected to terminal 29 or remove short-circuit connection. Check *5-00 Digital I/O Mode* and *5-02 Terminal 29 Mode*.

WARNING 42, Overload of Digital Output On X30/6

Check the load connected to X30/6 or remove short-circuit connection. Check *5-32 Term X30/6 Digi Out (MCB 101)*.

WARNING 42, Overload of Digital Output On X30/7

Check the load connected to X30/7 or remove short-circuit connection. Check *5-33 Term X30/7 Digi Out (MCB 101)*.

WARNING 47, 24 V supply low

The external 24 V DC backup power supply may be overloaded, otherwise contact your Danfoss supplier.

ALARM 48, 1.8 V supply low

Contact your Danfoss supplier.

WARNING 49, Speed limit

When the speed is not within the specified range in *4-11 Motor Speed Low Limit [RPM]* and *4-13 Motor Speed High Limit [RPM]* the frequency converter will show a warning. When the speed is below the specified limit in *1-86 Compressor Min. Speed for Trip [RPM]* (except when starting or stopping) the frequency converter will trip.

ALARM 50, AMA calibration failed

Contact your Danfoss supplier.

ALARM 51, AMA check U_{nom} and I_{nom}

The setting of motor voltage, motor current, and motor power is presumably wrong. Check the settings.

ALARM 52, AMA low I_{nom}

The motor current is too low. Check the settings.

ALARM 53, AMA motor too big

The motor is too big for the AMA to be carried out.

ALARM 54, AMA motor too small

The motor is too small for the AMA to be carried out.

ALARM 55, AMA par. out of range

The par. values found from the motor are outside acceptable range.

ALARM 56, AMA interrupted by user

The AMA has been interrupted by the user.

ALARM 57, AMA timeout

Try to start the AMA again a number of times, until the AMA is carried out. Please note that repeated runs may heat the motor to a level where the resistance R_s and R_r are increased. In most cases, however, this is not critical.

WARNING/ALARM 58, AMA internal fault

Contact your Danfoss supplier.

WARNING 59, Current limit

The current is higher than the value in *4-18 Current Limit*.

WARNING 60, External Interlock

External Interlock has been activated. To resume normal operation, apply 24 V DC to the terminal programmed for External Interlock and reset the frequency converter (via Bus, Digital I/O or by pressing [Reset]).

WARNING 62, Output Frequency at Maximum Limit

The output frequency is limited by the value set in *4-19 Max Output Frequency*.

WARNING 64, Voltage Limit

The load and speed combination demands a motor voltage higher than the actual DC link voltage.

WARNING/ALARM/TRIP 65, Control Card Over Temperature

Control card over temperature: The cut-out temperature of the control card is 80 °C.

WARNING 66, Heatsink Temperature Low

The heat sink temperature is measured as 0 °C. This could indicate that the temperature sensor is defective and thus the fan speed is increased to the maximum in case the power part or control card is very hot.

ALARM 67, Option Configuration has Changed

One or more options has either been added or removed since the last power-down.

ALARM 68, Safe Stop

Safe Stop has been activated. To resume normal operation, apply 24 V DC to terminal 37 then send a Reset signal (via Bus, Digital I/O or by pressing [Reset]).

ALARM 70, Illegal Frequency Converter Configuration

Actual combination of control board and power board is illegal.

ALARM 80, Drive Initialised to Default Value

Parameter settings are initialised to default setting after a manual (three-finger) reset or via *14-22 Operation Mode*. If the temperature is below 15 °C the warning will be present.

WARNING/ALARM 92, NoFlow

A no load situation has been detected for the system. See parameter group 22-2*.

WARNING/ALARM 93, Dry Pump

A no flow situation and high speed indicates that the pump has run dry. See parameter group 22-2*

WARNING/ALARM 94, End of Curve

Feed back stays lower than the set point, which may be indicates a leakage in the pipe system. See parameter group 22-5*

WARNING/ALARM 95, Broken Belt

Torque is below the torque level set for no load indicating a broken belt. See parameter group 22-6*

WARNING 96, Start Delayed

Start of the motor has been delayed due to short cycle protection is active. See parameter group 22-7*.

WARNING 97, Stop Delayed

Stop of the motor has been delayed due to short cycle protection is active. See parameter group 22-7*

WARNING 98, Clock Fault

Date and time has not been set or any back up mounted has failed. See parameter group 0-7*.

WARNING 200, Fire Mode

The input command Fire Mode is active. See parameter group 24-0*

WARNING 201, Fire M was Active

The input command Fire Mode has been active, but now deactivated. See parameter group 0-7*

WARNING 202, Fire M Limits Exceeded

One or more warranty voiding alarms have been suppressed during Fire Mode. See parameter group 0-7*

ALARM 250, New Spare Part

The power or Switch Mode Power Supply has been exchanged. The frequency converter type code must be restored in the EEPROM. Select the correct type code in Par 14-23 according to the label on unit. Remember to select 'Save to EEPROM' to complete.

ALARM 251, New Type Code

The frequency converter has got a new type code.

Index

+

- ++Zone Delay, 25-26**..... 153
- +Zone**
 - Delay, 25-24..... 152
 - [unit], 25-21..... 152

A

- Abbreviations**..... 3
- Acceleration Time**..... 52
- Alarm**
 - Log..... 101
 - Words..... 192
- Analog**
 - I/O Option MCB 109, 26-** 157
 - Input Scaling Value..... 160
 - Inputs..... 4
- Auto**
 - Derate..... 97
 - Energy Optimization Compressor..... 36
 - Energy Optimization VT..... 36

B

- Brake Power**..... 5
- Break-away Torque**..... 4
- Broken Belt Detection**..... 135
- Bus Controlled**..... 70

C

- Cascade Controller, 25-00**..... 151
- Changing**
 - A Group Of Numeric Data Values..... 23
 - A Text Value..... 22
 - Data..... 22
- Clockwise**..... 44
- Coasting**..... 4, 15
- Communication Option**..... 197
- Compressor**
 - Interlock, 25-90..... 156
 - Min. Speed For Trip [Hz], 1-87..... 46
 - Min. Speed For Trip [rpm], 1-86..... 46
- Condenser VT**..... 36
- Configuration**..... 79
- Control Cables**..... 9
- Cooling**..... 46
- Current Limit Control**..... 95

D

- Data Log Settings**..... 99
- Day/ Night Bus Indicator, 28-71**..... 165

- DC Link**..... 195
- Default Settings**..... 167, 23
- Definitions**..... 4
- Delayed Compressor Start, 28-91**..... 166
- Destage Function, 25-33**..... 153
- Destaging**
 - Speed, 25-47..... 155
 - Threshold, 25-43..... 154
- Digital Input**..... 156
- DP0 Offset, 28-81**..... 165
- Drive**
 - Identification..... 102
 - Information..... 99

E

- Efficient Parameter Set-up For VLT Refrigeration Drive Applications**..... 18
- Electrical Terminals**..... 8
- Enable Day/ Night Via Bus, 28-72**..... 165
- End Of Curve**..... 135
- Energy**
 - Log..... 145
 - Optimising..... 95
- Environment**..... 96
- ETR**..... 105, 195
- Example Of Changing Parameter Data**..... 18
- Extended**
 - CL Autotuning..... 121
 - Status Word..... 194
 - Status Word 2..... 194

F

- Fault Messages**..... 195
- FC**
 - Closed Loop..... 112
 - Type, 15-40..... 102
- Feedback**
 - Feedback..... 112
 - & Setpoint..... 114
 - 1 Conversion, 20-01..... 113
 - 1 Source Unit, 20-02..... 113
 - Adv. Conversion..... 115
- Fixed Speed Neutral Zone [unit], 25-23**..... 152
- Flow Compensation**..... 136
- Freeze Output**..... 4
- Function Setups**..... 20

G

- Graphical Display**..... 11

H	
Historic Log.....	100
How To Operate Graphical LCP (GLCP).....	11
I	
Indicator Lights (LEDs).....	12
Initialisation.....	23
Injection_on, 28-90.....	166
Intermediate Circuit.....	195
Interval Between Starts, 22-76.....	136
J	
Jog.....	4
K	
KTY Sensor.....	195
L	
Language	
Package 1.....	25
Package 2.....	25
LCP	
LCP.....	4, 5, 17
102.....	11
LEDs.....	11
Local Reference.....	26
M	
Main	
Menu - Frequency Converter Information - Group 15.....	99
Menu Mode.....	13, 17, 22
Menu Structure.....	25
Reactance.....	38
Mains	
On/Off.....	93
Supply.....	6
Manual Initialisation.....	24
Motor	
Protection.....	46
Status.....	104
N	
Neutral Zone [unit] , 25-20.....	151
Night	
Setback, 28-73.....	165
Speed Drop Override, 28-75.....	165
Speed Drop, 28-74.....	165
NLCP.....	15
No Trip At Inverter Overload.....	97
O	
OFF Action, 23-03.....	141
ON Action, 23-01.....	140
Operating Mode.....	26
Option Ident.....	102
P	
P0	
Maximum Reference, 28-86.....	166
Minimum Reference, 28-85.....	166
Reference, 28-84.....	166
Setpoint, 28-83.....	166
P0, 28-82.....	166
Parameter	
Info.....	103
Options.....	167
Selection.....	22
Set-Up.....	17
Password.....	34
PID	
Autotuning.....	117
Basic Settings.....	118
Differentiation Time, 20-95.....	120
Normal/Inverse Control, 20-81.....	118
Potentiometer Reference.....	10
Power Section, 15-41.....	102
Protection Mode.....	7
Protocol, 8-30.....	80
Pulse Start/Stop.....	10
Q	
Quick	
Menu.....	13
Menu Mode.....	13, 17
Transfer Of Parameter Settings Between Multiple Frequency Converters.....	17
R	
Rated Motor Speed.....	4
RCD.....	5
Read-out And Programming Of Indexed Parameters.....	23
Reference/Feedback Unit, 20-12.....	114
Refrigerant, 20-30.....	116
Relay Outputs.....	63
Reset Mode, 14-20.....	93
S	
Safety Precautions.....	6
Screened/armoured.....	9
Serial Communication.....	4

Short
 Cycle Protection..... 136
 Cycle Protection, 22-75..... 136

Sleep Mode..... 132

Special Functions..... 93

Speed Up/Down..... 10

Staging
 Speed, 25-44..... 154
 Threshold, 25-42..... 154

Start
 Delay..... 44, 43
 Function..... 44

Start/Stop..... 9

Stator Leakage Reactance..... 38

Status
 Status..... 13
 Messages..... 11

Step-by-Step..... 23

Symbols..... 3

Synchronous Motor Speed..... 4

T
Thermal Load..... 41, 105
Thermistor..... 6
Timed Actions..... 140
Torque Characteristics, 1-03..... 36
Trending..... 147
Trip Reset..... 93

V
Value..... 23
Voltage Reference Via A Potentiometer..... 10
Voltage, 15-42..... 102
WCplus..... 6

W
Warning Words..... 193

-
-Zone
 Delay, 25-25..... 152
 [unit], 25-22..... 152



www.danfoss.com/drives

Danfoss can accept no responsibility for possible errors in catalogues, brochures and other printed material. Danfoss reserves the right to alter its products without notice. This also applies to products already on order provided that such alterations can be made without subsequential changes being necessary in specifications already agreed. All trademarks in this material are property of the respective companies. Danfoss and the Danfoss logotype are trademarks of Danfoss A/S. All rights reserved.

